

# TRENDnet®



## Quick Installation Guide

---

## Industrial L2 Managed Switches

# Table of Contents

---

## **1 English**

1. Before You Start
2. Quick Reference
3. Hardware Installation
4. Hardware Configuration

## **12 Français**

1. Avant de commencer
2. Références rapides
3. Installation du matériel
4. Configuration du matériel

## **23 Deutsch**

1. Bevor Sie Anfängen
2. Schnellübersicht
3. Hardware-Installation
4. Hardwarekonfiguration

## **34 Español**

1. Antes de comenzar
2. Referencia rápida
3. Instalación del hardware
4. Configuración del hardware

## **45 Português**

1. Antes de Começar
2. Consulta rápida
3. Instalação do hardware
4. Configuração do hardware

## **56 Italiano**

1. Prima di cominciare
2. Riferimento rapido
3. Installazione hardware
4. Configurazione hardware

<https://www.trendnet.com/qig/1725>



## 1. Before You Start

### Package Contents

- TI-G642i/TI-G102i/TI-G160i
- Quick Installation Guide
- Console cable

### Minimum Requirements

- Power supply (ex. model TI-M6024)
- Networked computer
- RJ-45 Network Cable

### Optional Equipment

- 35mm DIN-Rail
- SFP modules (e.g. TI-MGBSX, TI-MGBS10, TI-MGB520, TI-MGBS40, TI-MGBRJ)

## 2. Quick Reference

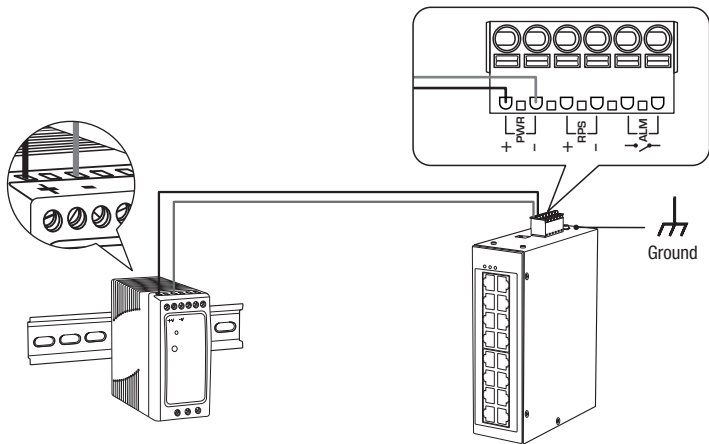

**Note:** The switch may be different than the one shown in the examples.

### 3. Hardware Installation

The switch can be placed on a desktop or mounted to a DIN-Rail.

#### DIN-rail Mounting Instructions

1. Attach the DIN-Rail mount to switch.

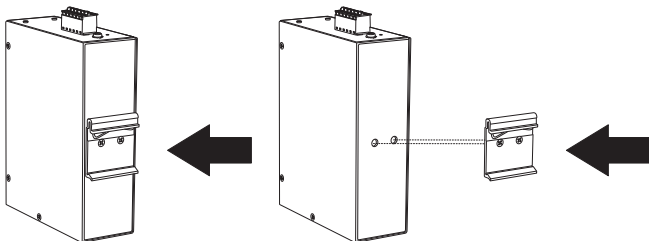

2. Position the unit in front of the DIN-Rail and hook the mount bracket over the top of the rail.
3. Rotate the switch downward towards the rail to lock it into place. You will know it is secure when you hear a click.

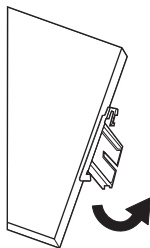

**Mounting the unit**

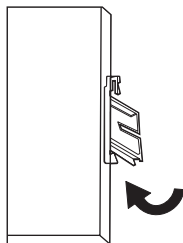

**Releasing the unit**

4. To remove the unit, pull down to clear the bottom of the DIN-Rail and rotate away from the rail.

## Applying Power

**Note:** Do not connect the power supply to a power source until the terminal connections are secured with the steps below.

1. Connect the power supply (sold separately) to the included terminal block (as shown below) and secure with the screws.

**Note:** Polarities must match.

2. Attach the terminal block to the unit.

**Optional:** The switch chassis can also be connected to a known grounding point for additional safety and protection (grounding wire is not included).

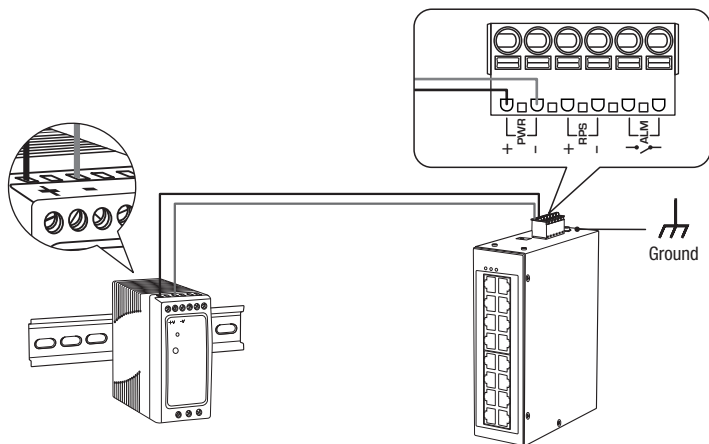

## Safety Note



- Turn off the power before connecting any module or wire. The correct power supply voltage is listed on the product label. Check the voltage of your power source to make sure that you are using the correct part. Do NOT use voltage greater than voltage range, as specified on the product label.
- Calculate the maximum possible current in each power wire and common wire. Observe all electrical codes dictating the maximum current allowable for each wire size. If the current surpasses the maximum ratings, the wiring could overheat, causing serious damage to your equipment.

## 4. Hardware Installation and Configuration

**Note:** If you are configuring the switch to be managed from your existing TRENDnet Hive cloud account, please follow the steps in Section A: Configuring the switch with TRENDnet Hive Cloud Management. If you are configuring the switch for local network management only, please follow the steps in Section B: Configuring the switch for local network management.

### Section A: Configuring the switch with TRENDnet Hive Cloud Management

**Note:** Configuration with TRENDnet Hive Cloud Management requires an existing network with Internet access and DHCP server for automatic IP addressing. The switch must be configured to reach the Internet in order to connect to your TRENDnet Hive Cloud Management account.

1. Connect an Ethernet/network cable to your computer and one of the switch ports.
2. Connect another Ethernet/network cable to one of your switch ports and to your existing network or router with Internet access and DHCP server for automatic IP addressing.

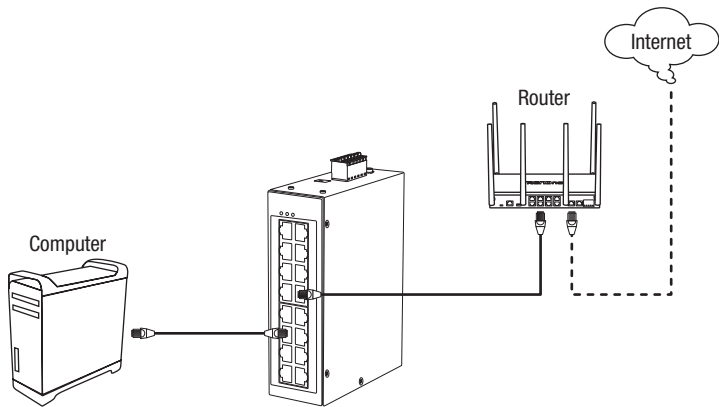

- ENGLISH
3. Assign a Static IP address to your computer's network adapter in the subnet of 192.168.10.x (e.g. 192.168.10.25) and a subnet mask of 255.255.255.0.
4. Open your web browser, type the IP address of the switch in the address bar, and then press **Enter**. The default IP address is 192.168.10.200 / 255.255.255.0.

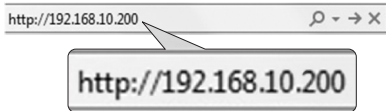

5. Click **Next** on the Switch Setup Wizard.

**Note:** If the switch setup wizard does not appear, you can click the setup wizard button  in the top right section of the switch management page to access the switch setup wizard.



6. You can change the switch administrator password by typing in the new password in the fields provided, then click **Next**.

**Note:** If entering a new password, please note that you will need to use the new password when logging into the switch management page for local management access moving forward.





7. For the method of management, select **TRENDnet Hive**.

**Note:** Configuration with TRENDnet Hive Cloud Management requires an existing network with Internet access and DHCP server for automatic IP addressing. The switch must be configured to reach the Internet in order to connect to your TRENDnet Hive Cloud Management account. If the switch is unable to reach to obtain IP address settings and DNS from the DHCP server and unable to reach the Internet, registration of the switch to your TRENDnet Hive cloud management account will fail.

Switch Setup Wizard

Step 2: Select the method of management for this switch

**TRENDnet Hive:** Choose this option if you would like to manage your switch through TRENDnet's Cloud Management. This option will automatically apply a DHCP connection (Dynamic IP Address) to your switch.  
**Note:** You will need a TRENDnet Hive account with a valid license to complete setup with this process. Choosing this option will prompt an immediate re-login to the device management page.

**Default Management:** Choose this option if you would like to manage your switch through the GUI. You may opt in to use TRENDnet Hive at a later date. Please note, this will set the IP of the switch to 192.168.10.200/255.255.255.0.

Previous Next

8. After selecting **TRENDnet Hive**, click **Next** and change your computer's network adapter settings to obtain an IP address automatically to continue the rest of the setup wizard.

**Note:** After selecting the TRENDnet Hive option and clicking **Next**, the switch will immediately change the switch default IP address settings to DHCP and obtain IP address settings from your existing network.



9. Select your **Time Zone**, then click **Next**.

Switch Setup Wizard

Step 3: Date/Time Settings

Current Time: 03 Dec 2021 14:34:48

Time Zone: (GMT-08:00) Pacific Time (US & Canada) / Ypavá

Previous Next Cancel

10. Enter the user account credentials for your TRENDnet Hive Cloud Management account to register the switch with your account, then click **Next**.

Switch Setup Wizard

Step 4: Input your Hive credentials to sync the switch to your Hive account.

Username	XXXXXXXXXX
Password	*****

Previous Next Cancel

11. The summary page will display all of the configuration settings that were applied through the setup wizard. Click **Apply** to complete the setup wizard.

**Note:** You may want to note the new password and IP address settings for local management access to switch.

Switch Setup Wizard

System Information

Write down the below information and store it in a safe place. The below information are the current settings that will be applied to the switch. Click **Apply** below to finalize the settings.

System Time	03 Dec 2021 14:28:23
Username	admin
Password	*****
Switch IP Address	192.168.10.200
Subnet Mask	255.255.255.0
Gateway IP Address	192.168.10.254
DNS	8.8.8.8

Previous Apply Cancel

12. To verify the switch is now successfully registered with your TRENDnet Hive Cloud Management account, the Hive button in the top right will be green to indicate successful registration.



## Section B: Configuring the switch for local network management

1. Connect an Ethernet/network cable to your computer and one of the switch ports.

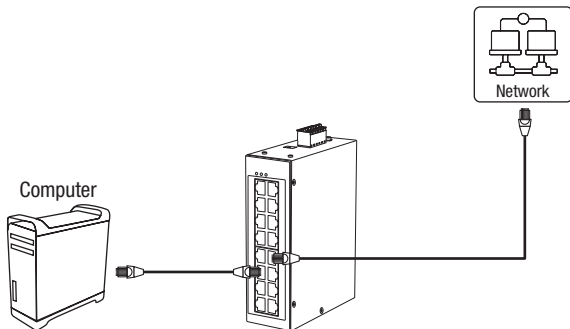

2. Assign a Static IP address to your computer's network adapter in the subnet of 192.168.10.x (e.g. 192.168.10.25) and a subnet mask of 255.255.255.0.
3. Open your web browser, type the IP address of the switch in the address bar, and then press **Enter**. The default IP address is 192.168.10.200 / 255.255.255.0.

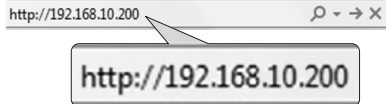

4. Click **Next** on the Switch Setup Wizard.

**Note:** If the switch setup wizard does not appear, you can click the setup wizard button  in the top right section of the switch management page to access the switch setup wizard.



5. You can change the switch administrator password by typing in the new password in the fields provided, then click **Next**.

**Note:** If entering a new password, please note that you will need to use the new password when logging into the switch management page for local management access moving forward.

Switch Setup Wizard

Step 1: Change your login credentials

Username	admin	
Password		(Maximum length is 20)
Confirm Password		

Previous Next Cancel

6. For the method of management, select **Default Management**.

Switch Setup Wizard

Step 2: Select the method of management for this switch

**TRENDnet Hive:** Choose this option if you would like to manage your switch through TRENDnet's Cloud Management. This option will automatically apply a DHCP connection (Dynamic IP Address) to your switch.  
**Note:** You will need a TRENDnet Hive account with a valid license to complete setup with this process. Choosing this option will prompt an immediate re-login to the device management page.

**Default Management:** Choose this option if you would like to manage your switch through the GUI. You may opt in to use TRENDnet Hive at a later date. Please note, this will set the IP of the switch to 192.168.10.200/255.255.255.0.

Previous Next

7. Configure the switch date and time settings, then click **Next**.

Switch Setup Wizard

Step 3: Date/Time Settings

Current Time	06 Dec 2021 13:37:33		
Date Settings	2021	/ 12	/ 05 (YYYYMMDD)
Time Settings	13	: 37	: 33 (HH:MM:SS)

Previous Next Cancel

8. Configure the switch IP address, subnet mask, gateway IP address, and DNS settings to match the requirements of your existing network using the fields provided, then click **Next**.

**Note:** If the switch IP address settings are changed to a different IP network subnet such as 192.168.1.x, 192.168.2.x, etc. your computer's network adapter settings will need to be changed to match the new IP address settings configured on the switch in order to access the switch management page.

Switch Setup Wizard	
Step 4: Input your IP settings in the fields below	
IP Address	192.168.10.200
Subnet Mask	255.255.255.0
Gateway IP Address	0.0.0.0
DNS	0.0.0.0
Previous Next Cancel	

9. The summary page will display all of the configuration settings that were applied through the setup wizard. Click **Apply** to complete the setup wizard.

**Note:** You may want to note the new password and IP address settings for local management access to switch.

Switch Setup Wizard	
System Information	
Write down the below information and store it in a safe place. The below information are the current settings that will be applied to the switch. Click <b>Apply</b> below to finalize the settings.	
System Time	09 Dec 2021 13:42:09
Username	admin
Password	****
Switch IP Address	192.168.10.200
Subnet Mask	255.255.255.0
Gateway IP Address	0.0.0.0
DNS	0.0.0.0
Previous Apply Cancel	

**Note:** To download the latest version of the User's Guide, please go to <https://www.trendnet.com/support> and select the **Switch Model** from the products drop-down list.

## 1. Avant de commencer

### Contenu de l'emballage

- TI-G642i/TI-G102i/TI-G160i
- Guide d'installation rapide
- Câble console

### Configuration minimale

- Alimentation électrique (ex. Modèles TI-M6024)
- Ordinateur en réseau
- Câble réseau RJ-45

### Matériel supplémentaire

- 35mm Rail DIN
- Module SFP (par exemple TI-MGBSX, TI-MGBS10, TI-MGB520, TI-MGBS40, TI-MGBRJ)

## 2. Référence rapides

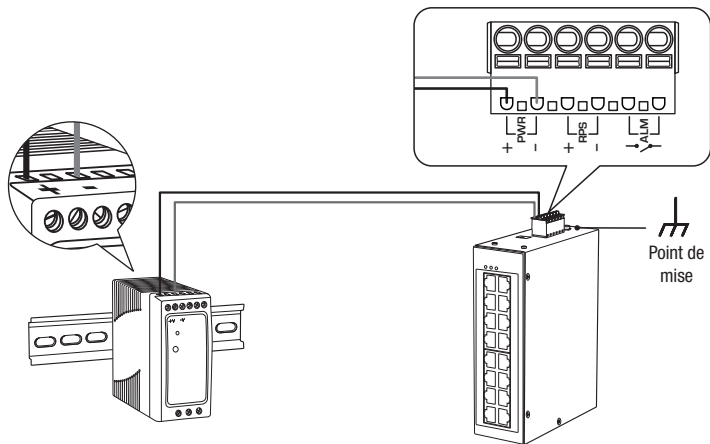

**Remarque:** Le modèle de switch peut être différent de celui montré dans l'exemple ci-dessous.

### 3. Installation du matériel

Le switch peut être placé sur un bureau, sur un mur ou fixé sur un Rail DIN.

#### Instructions de fixation sur Rail DIN

1. Fixez le support de fixation Rail DIN au switch.

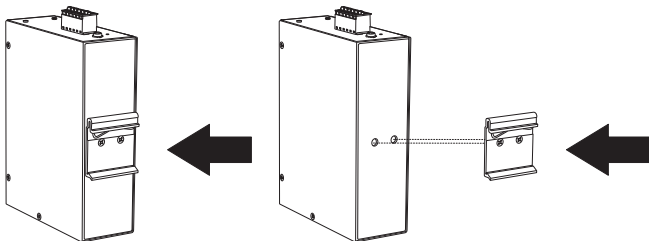

2. Installez l'appareil en face du Rail DIN et accrochez le support de fixation au-dessus du rail.
3. Faites pivoter le switch vers le bas en direction du rail afin de le fixer à son emplacement. Un clic vous avertira lorsqu'il est en place.

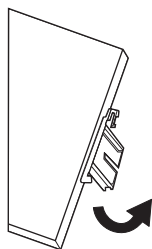

Fixation de l'appareil

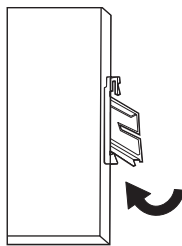

Détacher l'appareil

4. Pour enlever l'appareil, appuyez vers le bas afin de libérer le bas du Rail DIN et faites-le pivoter hors du rail.

## Mise sous tension

**Remarque:** Ne branchez pas le bloc d'alimentation sur une source d'énergie avant d'avoir sécurisé les connexions des bornes en suivant les étapes ci-dessous.

1. Connectez l'alimentation électrique (vendue séparément) au bornier fourni (comme illustré ci-dessous) et fixez-le à l'aide de vis.

**Remarque:** Respecter les polarités.

2. Attachez la borne d'alimentation à l'appareil.

**Optionnel :** Le châssis du commutateur peut également être connecté à un point de mise à la terre connu pour une sécurité et une protection supplémentaires (le fil de mise à la terre n'est pas inclus).

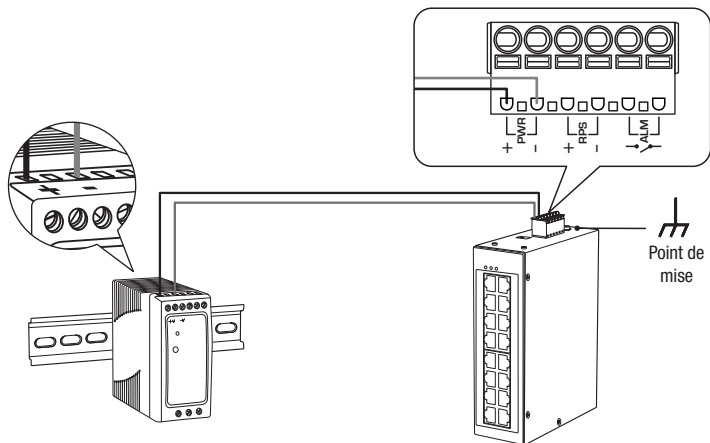



## Consignes de sécurité



- Coupez le courant avant de brancher quelque module ou câble que ce soit. Le voltage correct de l'alimentation est mentionné sur l'étiquette du produit. Vérifiez le voltage de votre source d'alimentation afin de vous assurer d'utiliser la pièce adéquate. N'utilisez PAS un voltage supérieur à plage de tension, tel que mentionné sur l'étiquette du produit.
- Calculez le courant maximum possible sur chaque câble d'alimentation et sur les câbles communs. Respectez tous les codes électriques indiquant le courant maximum accepté par chaque taille de fil. Si le courant dépasse les indications maximales, le câblage pourrait surchauffer et provoquer des dégâts importants à votre matériel.

## 4. Installation et configuration du matériel

**Remarque:** Si vous configurez le switch pour qu'il soit géré à partir de votre compte cloud TRENDnet Hive existant, veuillez suivre les étapes de la Section A: Configurer le switch avec TRENDnet Hive Cloud Management. Si vous configurez le switch pour la gestion du réseau local uniquement, veuillez suivre les étapes de la Section B: Configurer le switch pour la gestion du réseau local.

### Section A: Configurer le switch avec TRENDnet Hive Cloud Management

**Remarque:** La configuration avec TRENDnet Hive Cloud Management nécessite un réseau existant avec un accès Internet et un serveur DHCP pour l'adressage IP automatique. Le switch doit être configuré pour atteindre l'Internet afin de se connecter à votre compte TRENDnet Hive Cloud Management.

1. Connectez un câble Ethernet/réseau à votre ordinateur et à l'un des ports du switch.
2. Connectez un autre câble Ethernet/réseau à l'un des ports de votre switch et à votre réseau ou routeur existant avec accès Internet et serveur DHCP pour l'adressage IP automatique.

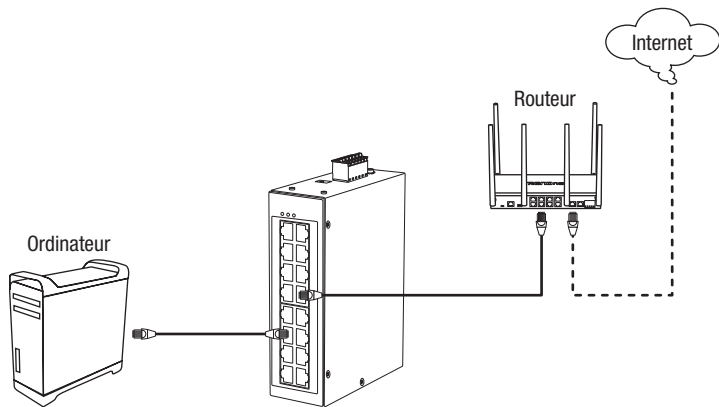

3. Assignez une adresse IP statique à l'adaptateur réseau de votre ordinateur dans le sous-réseau de 192.168.10.x (p. ex. 192.168.10.25) et un masque sous réseau de 255.255.255.0.
4. Ouvrez votre navigateur, entrez l'adresse IP du switch dans la barre d'adresse et appuyez sur **Enter** (Entrée). L'adresse IP par défaut est 192.168.10.200 / 255.255.255.0.

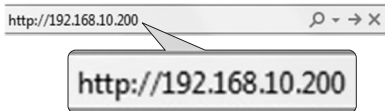

5. Cliquez sur **Next** (Suivant) dans la fenêtre Switch Setup Wizard (Assistant de configuration du switch).

**Remarque:** Si l'assistant de configuration du switch n'apparaît pas, vous pouvez cliquer sur le bouton set up wizard (Assistant de configuration)  dans la partie supérieure droite de la page de gestion du switch pour accéder à l'assistant de configuration du switch.



6. Vous pouvez modifier le mot de passe administrateur du switch en saisissant le nouveau mot de passe dans les champs prévus à cet effet, puis cliquez sur **Next** (Suivant).

**Remarque:** Si vous saisissez un nouveau mot de passe, veuillez noter que vous devrez utiliser ce nouveau mot de passe lorsque vous vous connecterez à la page de gestion du switch pour accéder à la gestion locale.



7. Pour la méthode de gestion, sélectionnez **TRENDnet Hive**.

**Remarque:** La configuration avec TRENDnet Hive Cloud Management nécessite un réseau existant avec un accès Internet et un serveur DHCP pour l'adressage IP automatique. Le switch doit être configuré pour atteindre l'Internet afin de se connecter à votre compte TRENDnet Hive Cloud Management. Si le switch ne parvient pas à obtenir les paramètres d'adresse IP et de DNS du serveur DHCP et ne parvient pas à accéder à Internet, l'enregistrement du switch sur votre compte TRENDnet Hive Cloud management échouera.

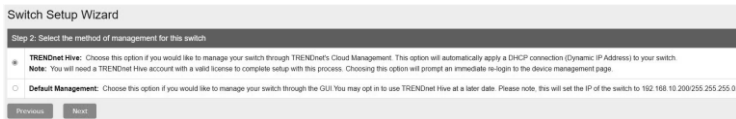

8. Après avoir sélectionné **TRENDnet Hive**, cliquez sur **Next** (Suivant) et modifiez les paramètres de l'adaptateur réseau de votre ordinateur pour obtenir une adresse IP automatiquement afin de poursuivre avec l'assistant d'installation.

**Remarque:** Après avoir sélectionné l'option TRENDnet Hive et cliqué sur **Next** (Suivant), le switch changera immédiatement ses paramètres d'adresse IP par défaut en DHCP et obtiendra les paramètres d'adresse IP de votre réseau existant.



9. Sélectionnez votre **Fuseau Horaire (Time Zone)**, et cliquez ensuite sur **Suivant** (Suivant).



10. Saisissez les informations d'identification du compte utilisateur de votre compte TRENDnet Hive Cloud Management pour que le switch soit enregistré sur votre compte, puis cliquez sur **Next** (Suivant).

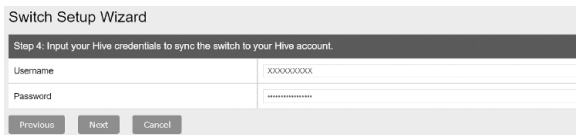

Switch Setup Wizard	
Step 4: Input your Hive credentials to sync the switch to your Hive account.	
Username	XXXXXXXXXX
Password	XXXXXXXXXX
Previous Next Cancel	

11. La page de résumé affiche tous les paramètres de configuration qui ont été appliqués par l'intermédiaire de l'assistant de configuration. Cliquez sur **Apply** (Appliquer) pour terminer l'installation.

**Remarque:** Vous pouvez noter les nouveaux paramètres de mot de passe et d'adresse IP pour l'accès à la gestion locale du switch.



Switch Setup Wizard	
System Information	
Write down the below information and store it in a safe place. The below information are the current settings that will be applied to the switch. Click Apply below to finalize the settings.	
System Time	03 Dec 2021 14:28:23
Username	admin
Password	*****
Switch IP Address	192.168.10.200
Subnet Mask	255.255.255.0
Gateway IP Address	192.168.10.254
DNS	8.8.8.8
Previous Apply Cancel	

12. Pour vérifier que le switch est maintenant enregistré avec succès dans votre compte TRENDnet Hive Cloud Management, le bouton Hive dans la partie supérieure droite sera vert pour indiquer que l'enregistrement a réussi.



## Section B: Configurer le switch pour la gestion du réseau local

1. Connectez un câble Ethernet/réseau à votre ordinateur et à l'un des ports du switch.

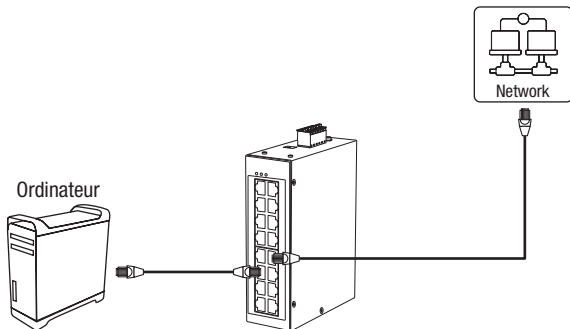

2. Assignez une adresse IP statique à l'adaptateur réseau de votre ordinateur dans le sous-réseau de 192.168.10.x (p. ex. 192.168.10.25) et un masque sous réseau de 255.255.255.0.
3. Ouvrez votre navigateur, entrez l'adresse IP du switch dans la barre d'adresse et appuyez sur **Enter** (Entrée). L'adresse IP par défaut est 192.168.10.200 / 255.255.255.0.

http://192.168.10.200

http://192.168.10.200

4. Cliquez sur **Next** (Suivant) dans la fenêtre Switch Setup Wizard (Assistant de configuration du switch).

**Remarque:** Si l'assistant de configuration du switch n'apparaît pas, vous pouvez cliquer sur le bouton set up wizard (Assistant de configuration)  dans la partie supérieure droite de la page de gestion du switch pour accéder à l'assistant de configuration du switch.

### Switch Setup Wizard

This wizard will guide you through a step-by-step process to configure your switch and connect to the Internet.

Next

Cancel

5. Vous pouvez modifier le mot de passe administrateur du switch en saisissant le nouveau mot de passe dans les champs prévus à cet effet, puis cliquez sur **Next** (Suivant).

**Remarque:** Si vous saisissez un nouveau mot de passe, veuillez noter que vous devrez utiliser ce nouveau mot de passe lorsque vous vous connecterez à la page de gestion du switch pour accéder à la gestion locale.

The screenshot shows the 'Switch Setup Wizard' interface. The title is 'Switch Setup Wizard' and the step is 'Step 1: Change your login credentials'. There are three input fields: 'Username' with the value 'admin', 'Password', and 'Confirm Password'. A note next to the Password field says '(Maximum length is 20)'. At the bottom, there are three buttons: 'Previous', 'Next', and 'Cancel'.

6. Pour la méthode de gestion, sélectionnez **Default Management** (Gestion par défaut).

The screenshot shows the 'Switch Setup Wizard' interface. The title is 'Switch Setup Wizard' and the step is 'Step 2: Select the method of management for this switch'. There are two radio button options: 'TRENDnet Hive' and 'Default Management'. The 'Default Management' option is selected. A note below the options says: 'Please note, this will set the IP of the switch to 192.168.10.200/255.255.255.0'. At the bottom, there are two buttons: 'Previous' and 'Next'.

7. Configurez les paramètres de date et d'heure du switch, puis cliquez sur **Next** (Suivant).

The screenshot shows the 'Switch Setup Wizard' interface. The title is 'Switch Setup Wizard' and the step is 'Step 3: Date/Time Settings'. There are three rows of settings: 'Current Time' with the value '06 Dec 2021 13:37:33', 'Date Settings' with fields for year (2021), month (12), and day (05), and 'Time Settings' with fields for hour (13), minute (37), and second (33). At the bottom, there are three buttons: 'Previous', 'Next', and 'Cancel'.

8. Configurez l'adresse IP, le masque de sous-réseau, l'adresse IP de la passerelle et les paramètres DNS du switch afin qu'ils correspondent aux exigences de votre réseau existant à l'aide des champs fournis, puis cliquez sur **Next** (Suivant).

**Remarque:** Si les paramètres de l'adresse IP du switch sont modifiés pour un sous-réseau IP différent, tels que 192.168.1.x, 192.168.2.x, etc., les paramètres de l'adaptateur réseau de votre ordinateur devront être modifiés pour correspondre aux nouveaux paramètres d'adresse IP configurés sur le switch afin d'accéder à la page de gestion du switch.

Switch Setup Wizard	
Step 4: Input your IP settings in the fields below	
IP Address	192.168.10.200
Subnet Mask	255.255.255.0
Gateway IP Address	0.0.0.0
DNS	0.0.0.0
Previous Next Cancel	

9. La page de résumé affiche tous les paramètres de configuration qui ont été appliqués par l'intermédiaire de l'assistant de configuration. Cliquez sur **Apply** (Appliquer) pour terminer l'installation.

**Remarque:** Vous pouvez noter les nouveaux paramètres de mot de passe et d'adresse IP pour l'accès à la gestion locale du switch.

Switch Setup Wizard	
System Information	
Write down the below information and store it in a safe place. The below information are the current settings that will be applied to the switch. Click <b>Apply</b> below to finalize the settings.	
System Time	08 Dec 2021 13:42:09
Username	admin
Password	*****
Switch IP Address	192.168.10.200
Subnet Mask	255.255.255.0
Gateway IP Address	0.0.0.0
DNS	0.0.0.0
Previous Apply Cancel	

**Remarque:** Pour télécharger la dernière version du guide de l'utilisateur, veuillez vous rendre sur: <https://www.trendnet.com/support> et sélectionnez **Switch Model** ans la liste déroulante Téléchargement de produits.



# 1. Bevor Sie Anfängen

## Paketinhalte

- TI-G642i/TI-G102i/TI-G160i
- Schnellinstallationsanleitung
- Konsolenkabel

## Mindestanforderungen

- Stromversorgung (außer Modelle TI-M6024)
- Networked computer
- RJ-45 Netzwerkkabe

## Optionale Ausrüstung

- 35mm DIN-Schiene
- SFP Module (z.B. TI-MGBSX, TI-MGBS10, TI-MGB520, TI-MGBS40, TI-MGBRJ)

# 2. Schnellübersicht

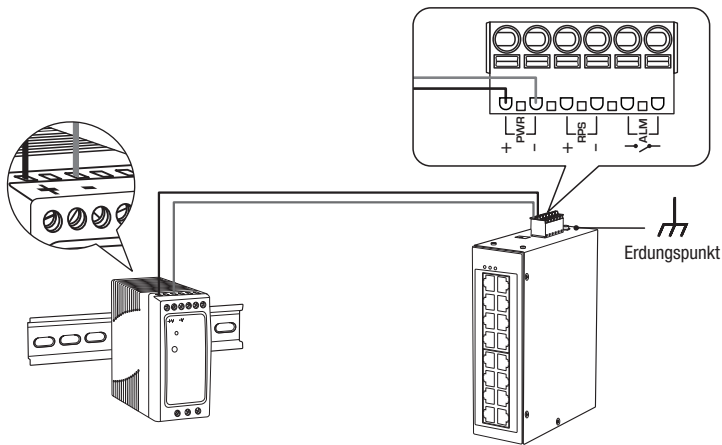

**Hinweis:** Das Switchmodell kann sich von dem im folgenden Beispiel gezeigten unterscheiden.

### 3. Hardware-Installation

Der switch kann auf einem Schreibtisch platziert oder an der mit einer DIN-Schiene angebracht werden.

#### **Befestigungsanleitung für DIN-Schiene**

1. Befestigen Sie die DIN-Schiene am switch.

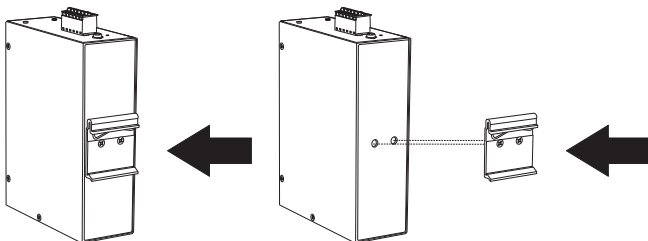

2. Positionieren Sie das Gerät vor der DIN-Schiene und haken Sie die Befestigungshalterung über die Oberseite der Schiene.
3. Drehen Sie den switch zum Einrasten nach unten zur Schiene hin. Wenn Sie ein Klicken hören, ist das Gerät sicher eingerastet.

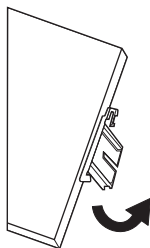

**Befestigung des Geräts**

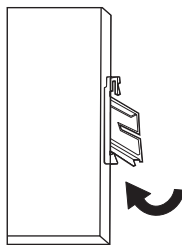

**Abnahme des Geräts**

4. Um das Gerät abzunehmen, ziehen Sie es bitte herunter, um es von der Unterseite der Schiene zu entfernen und drehen Sie es von der Schiene weg.

## Strom Zuführen

**Hinweis:** Stromversorgung nicht herstellen, bis die Anschlussverbindungen wie folgt gesichert wurden.

1. Schließen Sie die Stromversorgung (separat erhältlich) an die inbegriffene Klemmleiste an (wie unten abgebildet) und ziehen Sie die Schrauben an.

**Hinweis:** Polaritäten müssen übereinstimmen.

2. Befestigen Sie die Klemmleiste am Gerät.

**Fakultativ:** Das Switch-Gehäuse kann für mehr Sicherheit und Schutz auch mit einem bekannten Erdungspunkt verbunden werden (Erdungskabel nicht inbegriffen).

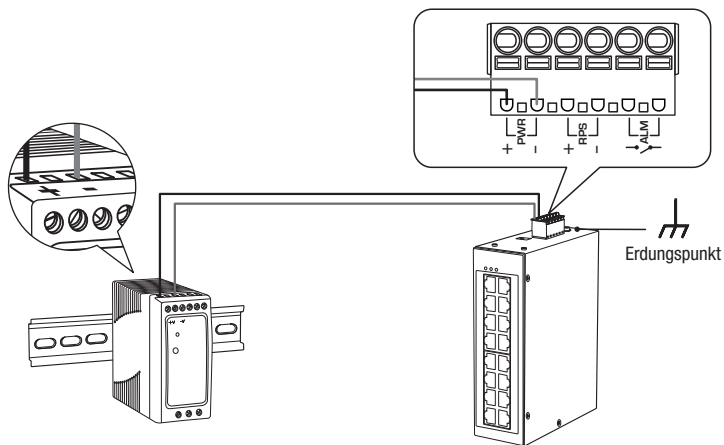

## Sicherheitsanmerkung



- Schalten Sie das Gerät aus, bevor Sie ein Modul oder ein Kabel anschließen. Die korrekte Versorgungsspannung befindet sich auf dem Produktetikett. Prüfen Sie die Spannung Ihrer Stromquelle, um sicher zu stellen, dass Sie das korrekte Teil verwenden. Verwenden Sie KEINE Spannung, welche die auf dem Produktetikett angegebene Spannung von Spannungsbereich überschreitet.
- Berechnen Sie den maximal möglichen Strom für jedes Kabel und die gemeinsame Leitung. Beachten Sie alle Elektrorichtlinien, die den maximal zulässigen Strom für jede Kabelgröße vorschreiben. Bei Überschreitung der Maximalwerte können sich die Kabel überhitzen und Ihre Ausrüstung schwer beschädigen.

## 4. Hardware-Installation und Konfiguration

**Hinweis:** Wenn Sie den Switch so konfigurieren, dass er über Ihr bestehendes TRENDnet Hive Cloud-Konto verwaltet werden kann, folgen Sie bitte den Schritten in Abschnitt A: Konfigurieren des Switches mit TRENDnet Hive Cloud Management. Wenn Sie den Switch nur für die lokale Netzwerkverwaltung konfigurieren, führen Sie bitte die Schritte in Abschnitt B: Konfigurieren des Switches für die lokale Netzwerkverwaltung aus.

### **Abschnitt A: Konfigurieren des Switches mit TRENDnet Hive Cloud Management**

**Hinweis:** Die Konfiguration mit TRENDnet Hive Cloud Management erfordert ein bestehendes Netzwerk mit Internetzugang und DHCP-Server für die automatische IP-Adressierung. Der Switch muss so konfiguriert sein, dass er das Internet erreichen kann, um eine Verbindung zu Ihrem TRENDnet Hive Cloud Management-Konto herzustellen.

1. Verbinden Sie ein Ethernet-/Netzwerkkabel mit Ihrem Computer und einem der Switch-Ports.
2. Schließen Sie ein weiteres Ethernet-/Netzwerkkabel an einen der Switch-Anschlüsse und an Ihr bestehendes Netzwerk oder Ihren Router mit Internetzugang und DHCP-Server für die automatische IP-Adressierung an.

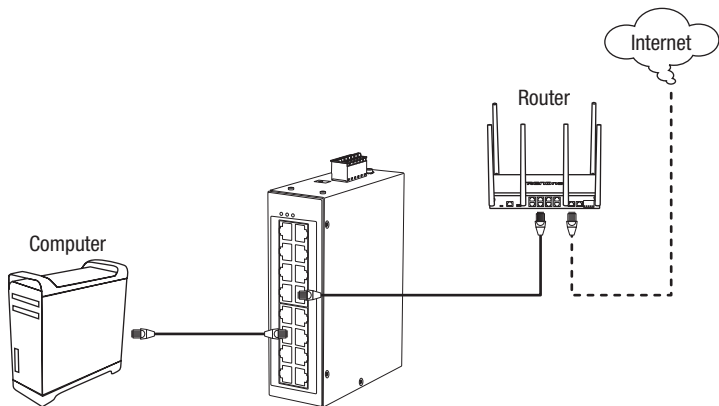

3. Weisen Sie dem Netzwerkadapter Ihres Computers eine statische IP-Adresse im Subnetz 192.168.10.x (z.B. 192.168.10.25) und die Subnetzmaske 255.255.255.0 zu.
4. Öffnen Sie Ihren Webbrowser, geben Sie die IP-Adresse des Switch in die Adressleiste ein und drücken Sie auf die **Enter** (Eingabetaste). Die Standard-IP-Adresse lautet 192.168.10.200 / 255.255.255.0.

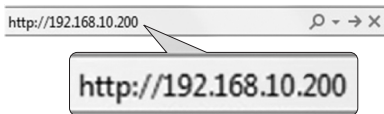

5. Klicken Sie im Switch Setup Wizard (Switch-Setup-Assistenten) auf **Next** (Weiter).

**Hinweis:** Wenn der Switch-Setup-Assistent nicht angezeigt wird, können Sie auf die Schaltfläche Setup-Assistent  im oberen rechten Bereich der Switch-Verwaltungsseite klicken, um den Switch-Setup-Assistenten aufzurufen.



6. Sie können das Passwort des Switch-Administrators ändern, indem Sie das neue Passwort in die vorgesehenen Felder eingeben und dann auf **Next** (Weiter) klicken.

**Hinweis:** Wenn Sie ein neues Kennwort eingeben, beachten Sie bitte, dass Sie das neue Kennwort verwenden müssen, wenn Sie sich auf der Switch-Verwaltungsseite für den lokalen Verwaltungszugang anmelden.



## 7. Wählen Sie für die Verwaltungsmethode **TRENDnet Hive**.

**Hinweis:** Die Konfiguration mit TRENDnet Hive Cloud Management erfordert ein bestehendes Netzwerk mit Internetzugang und DHCP-Server für die automatische IP-Adressierung. Der Switch muss so konfiguriert sein, dass er das Internet erreichen kann, um eine Verbindung zu Ihrem TRENDnet Hive Cloud Management-Konto herzustellen. Wenn der Switch nicht in der Lage ist, IP-Adresseinstellungen und DNS vom DHCP-Server zu erhalten und das Internet zu erreichen, schlägt die Registrierung des Switches für Ihr TRENDnet Hive Cloud Management-Konto fehl.

Switch Setup Wizard

Step 2: Select the method of management for this switch

**TRENDnet Hive:** Choose this option if you would like to manage your switch through TRENDnet's Cloud Management. This option will automatically apply a DHCP connection (Dynamic IP Address) to your switch.  
**Note:** You will need a TRENDnet Hive account with a valid license to complete setup with this process. Choosing this option will prompt an immediate re-login to the device management page.

**Default Management:** Choose this option if you would like to manage your switch through the GUI. You may opt in to use TRENDnet Hive at a later date. Please note, this will set the IP of the switch to 192.168.13.209/255.255.255.0.

Previous Next

## 8. Klicken Sie nach der Auswahl von **TRENDnet Hive auf Next (Weiter)** und ändern Sie die Netzwerkadaptiereinstellungen Ihres Computers, um eine IP-Adresse automatisch zu beziehen, um mit dem Rest des Einrichtungsassistenten fortzufahren.

**Hinweis:** Nachdem Sie die Option TRENDnet Hive ausgewählt und auf **Next (Weiter)** geklickt haben, ändert der Switch sofort die Standard-IP-Adresseinstellungen des Switches auf DHCP und bezieht die IP-Adresseinstellungen von Ihrem bestehenden Netzwerk.

Previous Next

## 9. Wählen Sie Ihre **Time Zone** (Zeitzone) aus und klicken Sie dann auf **Next (Weiter)**.

Switch Setup Wizard

Step 3: Date/Time Settings

Current Time 03 Dec 2021 14:34:48

Time Zone (GMT-08:00) Pacific Time (US & Canada),Tijuana

Previous Next Cancel

10. Geben Sie die Anmeldedaten für Ihr TRENDnet Hive Cloud Management-Konto ein, um den Switch mit Ihrem Konto zu registrieren, und klicken Sie dann auf **Next** (Weiter).

Switch Setup Wizard

Step 4: Input your Hive credentials to sync the switch to your Hive account.

Username	XXXXXXXXXX
Password	*****

Previous Next Cancel

11. Auf der Übersichtsseite werden alle Konfigurationseinstellungen angezeigt, die durch den Einrichtungsassistenten vorgenommen wurden. Klicken Sie auf **Apply** (Übernehmen), um den Einrichtungsassistenten abzuschließen.

**Hinweis:** Notieren Sie sich die neuen Kennwort- und IP-Adresseinstellungen für den lokalen Verwaltungszugriff auf den Switch.

Switch Setup Wizard

System Information

Write down the below information and store it in a safe place. The below information are the current settings that will be applied to the switch. Click **Apply** below to finalize the settings.

System Time	03 Dec 2021 14:28:23
Username	admin
Password	*****
Switch IP Address	192.168.10.200
Subnet Mask	255.255.255.0
Gateway IP Address	192.168.10.254
DNS	8.8.8.8

Previous Apply Cancel

12. Um zu überprüfen, ob der Switch nun erfolgreich bei Ihrem TRENDnet Hive Cloud Management-Konto registriert ist, leuchtet die Hive-Schaltfläche oben rechts grün, um die erfolgreiche Registrierung anzuzeigen.





## Section B: Configuring the switch for local network management

1. Verbinden Sie ein Ethernet-/Netzwerk-kabel mit Ihrem Computer und einem der Switch-Ports.

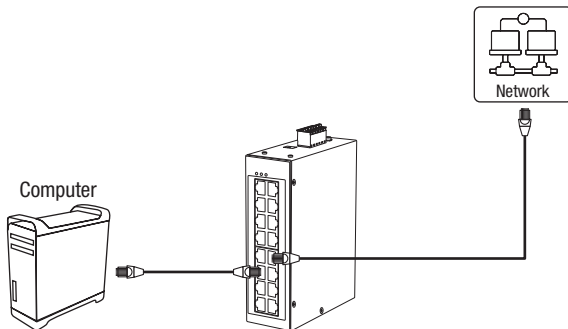

2. Weisen Sie dem Netzwerkadapter Ihres Computers eine statische IP-Adresse im Subnetz 192.168.10.x (z.B. 192.168.10.25) und die Subnetzmaske 255.255.255.0 zu.
3. Öffnen Sie Ihren Webbrowser, geben Sie die IP-Adresse des Switch in die Adressleiste ein und drücken Sie auf die **Enter** (Eingabetaste). Die Standard-IP-Adresse lautet 192.168.10.200 / 255.255.255.0.

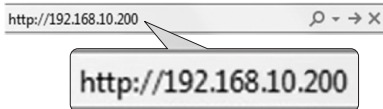

4. Klicken Sie im Switch Setup Wizard (Switch-Setup-Assistenten) auf **Next** (Weiter).

**Hinweis:** Wenn der Switch-Setup-Assistent nicht angezeigt wird, können Sie auf die Schaltfläche Setup-Assistent  im oberen rechten Bereich der Switch-Verwaltungsseite klicken, um den Switch-Setup-Assistenten aufzurufen.



5. Sie können das Passwort des Switch-Administrators ändern, indem Sie das neue Passwort in die vorgesehenen Felder eingeben und dann auf **Next** (Weiter) klicken.

**Hinweis:** Wenn Sie ein neues Kennwort eingeben, beachten Sie bitte, dass Sie das neue Kennwort verwenden müssen, wenn Sie sich auf der Switch-Verwaltungsseite für den lokalen Verwaltungszugang anmelden.

The screenshot shows the 'Switch Setup Wizard' interface for Step 1: 'Change your login credentials'. It features three input fields: 'Username' (with 'admin' entered), 'Password', and 'Confirm Password'. A note indicates the password maximum length is 20. At the bottom, there are 'Previous', 'Next', and 'Cancel' buttons.

6. Wählen Sie für die Verwaltungsmethode wählen **Default Management** (Sie Standardverwaltung).

The screenshot shows the 'Switch Setup Wizard' interface for Step 2: 'Select the method of management for this switch'. It presents two radio button options: 'TRENDnet Hive' (which is currently unselected) and 'Default Management' (which is selected). Each option includes a brief description and a note. At the bottom, there are 'Previous' and 'Next' buttons.

7. Konfigurieren Sie das Datum und die Uhrzeit des Switches, und klicken Sie dann auf **Next** (Weiter).

The screenshot shows the 'Switch Setup Wizard' interface for Step 3: 'Date/Time Settings'. It displays the current time as '08 Dec 2021 13:37:33'. Below this, there are input fields for 'Date Settings' (Year: 2021, Month: 12, Day: 08) and 'Time Settings' (Hour: 13, Minute: 37, Second: 33). The date format is (YYYYMMDD) and the time format is (HH:MM:SS). At the bottom, there are 'Previous', 'Next', and 'Cancel' buttons.

8. Konfigurieren Sie die IP-Adresse des Switches, die Subnetzmaske, die Gateway-IP-Adresse und die DNS-Einstellungen so, dass sie den Anforderungen Ihres bestehenden Netzwerks entsprechen, und klicken Sie dann auf **Next** (Weiter).

**Hinweis:** Wenn die IP-Adresseinstellungen des Switches auf ein anderes IP-Subnetz wie 192.168.1.x, 192.168.2.x usw. geändert werden, müssen die Netzwerkadaptereinstellungen Ihres Computers so geändert werden, dass sie mit den neuen IP-Adresseinstellungen des Switches übereinstimmen, damit Sie auf die Verwaltungsseite des Switches zugreifen können.

Switch Setup Wizard	
Step 4: Input your IP settings in the fields below	
IP Address	192.168.10.200
Subnet Mask	255.255.255.0
Gateway IP Address	0.0.0.0
DNS	0.0.0.0
Previous Next Cancel	

9. Auf der Übersichtsseite werden alle Konfigurationseinstellungen angezeigt, die durch den Einrichtungsassistenten vorgenommen wurden. Klicken Sie auf **Apply** (Übernehmen), um den Einrichtungsassistenten abzuschließen.

**Hinweis:** Notieren Sie sich die neuen Kennwort- und IP-Adresseinstellungen für den lokalen Verwaltungszugriff auf den Switch.

Switch Setup Wizard	
System Information	
Write down the below information and store it in a safe place. The below information are the current settings that will be applied to the switch. Click <b>Apply</b> below to finalize the settings.	
System Time	08 Dec 2021 13:42:09
Username	admin
Password	*****
Switch IP Address	192.168.10.200
Subnet Mask	255.255.255.0
Gateway IP Address	0.0.0.0
DNS	0.0.0.0
Previous Apply Cancel	

**Hinweis:** Um die neueste Version des Benutzerhandbuchs herunterzuladen, gehen Sie bitte zu: <https://www.trendnet.com/support> und wählen Sie **Switch Model** in der Dropdown-Liste Produkt-Download.

## 1. Antes de comenzar

### Contenidos del paquete

- TI-G642i/TI-G102i/TI-G160i
- Guía de instalación rápida
- Cable de consola

### Requisitos mínimos

- Fuente de alimentación (ej. modelos: TI-M6024)
- Computadora conectada en red
- Cable de red RJ-45

### Equipo opcional

- 35mm DIN-Rail
- Módulo SFP (e.g. TI-MGBSX, TI-MGBS10, TI-MGB520, TI-MGBS40, TI-MGBRJ)

## 2. Referencia rápida

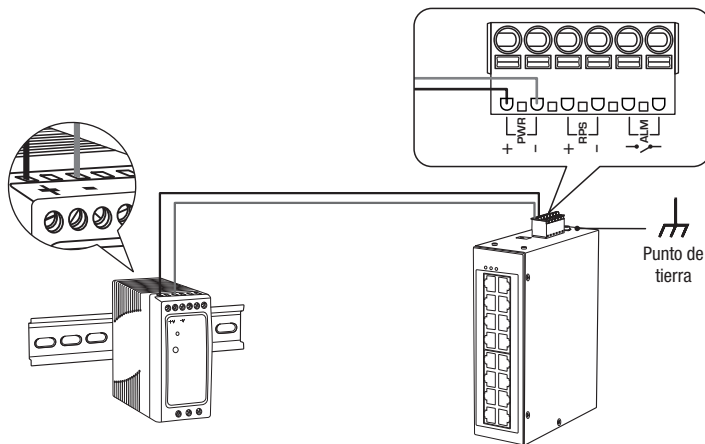

**Nota:** El modelo de switch puede ser diferente al que se muestra en el siguiente ejemplo.

### 3. Instalación del hardware

El switch puede colocarse en un escritorio o montarse en una pared o en DIN-Rail.

#### Instrucciones de montaje en DIN-Rail

1. Acople el soporte de montaje en DIN-Rail al switch.

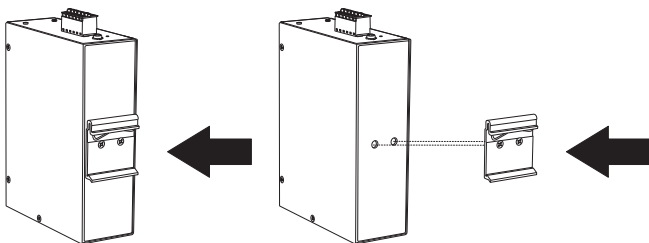

2. Coloque la unidad en frente del DIN-Rail y enganche el soporte de montaje sobre el carril.
3. Gire el para abajo, hacia el carril, hasta dejarlo bloqueado. Escuchará un clic cuando quede fijado.

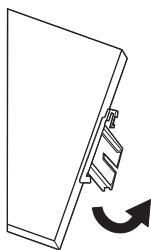

**Montando la unidad**

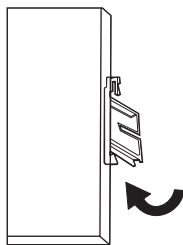

**Liberando la unidad**

4. Para retirar la unidad, presione hacia abajo para liberar la parte inferior el DIN-Rail y gírelo hasta sacarlo del carril.

## Aplicar la alimentación

**Nota:** No conecte la fuente de alimentación a una toma de corriente hasta que las conexiones de los terminales estén aseguradas con los pasos siguientes.

1. Conecte el adaptador de corriente (se vende por separado) al bloque de terminales incluido (según se indica más abajo) y fíjelo con los tornillos.

**Nota:** Las polaridades deben coincidir.

2. Acople el bloque de terminales a la unidad.

**Opcional:** El bastidor del switch también se puede conectar a un punto de tierra conocido para obtener mayor seguridad y protección (no se incluye el cable de tierra).

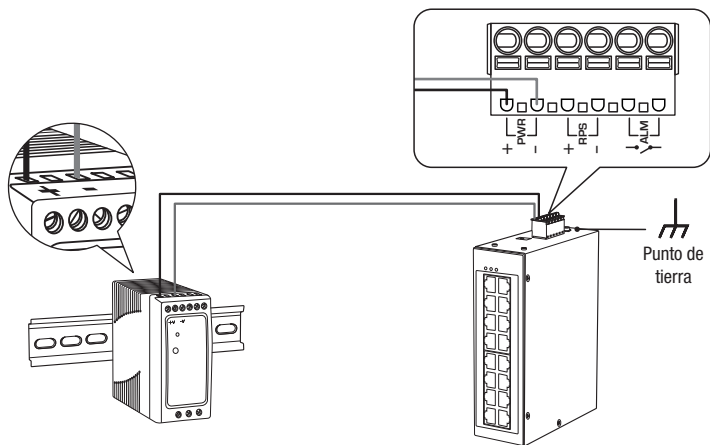

## Nota de seguridad



- Apague la alimentación antes de conectar cualquier módulo o cable. El voltaje correcto de suministro de alimentación figura en la etiqueta del producto. Compruebe el voltaje de su fuente de alimentación para asegurarse de que esté utilizando la parte correcta. NO utilice un voltaje superior a 4el rango de voltaje, según se especifica en la etiqueta del producto.
- Calcule la corriente máxima posible en cada cable de alimentación y cable común. Observe todos los códigos eléctricos que dictan la corriente máxima permisible para cada tamaño de cable. Si la corriente supera las clasificaciones máximas, el cableado podría sobrecalentarse y producir daños graves en su equipo.

## 4. Instalación y configuración del Hardware

**Nota:** Si está configurando el switch para ser gestionado desde su cuenta ya existente de la nube Hive de TRENDnet, siga los pasos de la Sección A: Configurar el switch con TRENDnet Hive Cloud Management. Si está configurando el switch sólo para la gestión de la red local, siga los pasos de la Sección B: Configurar el switch para la gestión de la red local.

### **Sección A: Configurar el switch con TRENDnet Hive Cloud Management**

**Nota:** La configuración con TRENDnet Hive Cloud Management requiere una red existente con acceso a Internet y un servidor DHCP para el direccionamiento automático de la IP. El switch debe estar configurado para llegar a Internet con el fin de conectarse a su cuenta de TRENDnet Hive Cloud Management.

1. Conecte un cable Ethernet/de red a su ordenador y a uno de los puertos del switch.
2. Conecte otro cable Ethernet/de red a uno de los puertos de su switch y a su red o router existente con acceso a Internet y servidor DHCP para el direccionamiento automático de IP.

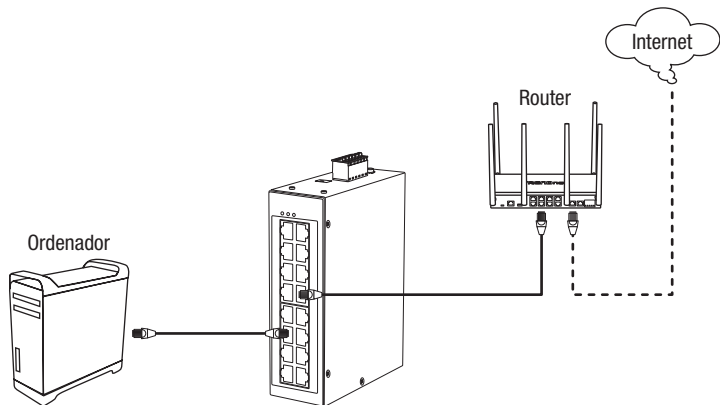



3. Asigne una dirección IP estática al adaptador de red de su computador en la máscara de subred de 192.168.10.x (e.j. 192.168.10.25) y máscara de subred de 255.255.255.0.
4. Abra su navegador Web, escriba la dirección IP del switch en la barra de dirección, y luego pulse **Enter** (Intro). La dirección IP por defecto es 192.168.10.200 / 255.255.255.0.

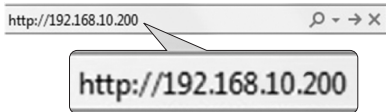

5. Haga clic en **Next** (Siguiente) en el Switch Setup Wizard (Asistente de configuración del switch).

**Nota:** Si no aparece el asistente de configuración del switch, puede hacer clic en el botón del asistente de configuración  en la sección superior derecha de la página de gestión del switch para acceder al asistente de configuración del switch.



6. Puede cambiar la contraseña del administrador del switch escribiendo la nueva contraseña en los campos proporcionados, luego haga clic en **Next** (Siguiente).

**Nota:** Si introduce una nueva contraseña, tenga en cuenta que deberá utilizarla cuando inicie sesión en la página de gestión del switch para acceder a la gestión local.



## 7. Para el método de gestión, seleccione **TRENDnet Hive**.

**Nota:** La configuración con TRENDnet Hive Cloud Management requiere una red existente con acceso a Internet y un servidor DHCP para el direccionamiento IP automático. El switch debe estar configurado para llegar a Internet con el fin de conectarse a su cuenta de TRENDnet Hive Cloud Management. Si el switch no puede obtener la configuración de la dirección IP y del DNS del servidor DHCP y no puede llegar a Internet, el registro del switch en su cuenta de gestión de la nube Hive de TRENDnet fallará.

Switch Setup Wizard

Step 2: Select the method of management for this switch

**TRENDnet Hive:** Choose this option if you would like to manage your switch through TRENDnet's Cloud Management. This option will automatically apply a DHCP connection (Dynamic IP Address) to your switch.  
**Note:** You will need a TRENDnet Hive account with a valid license to complete setup with this process. Choosing this option will prompt an immediate re-login to the device management page.

**Default Management:** Choose this option if you would like to manage your switch through the GUI. You may opt in to use TRENDnet Hive at a later date. Please note, this will set the IP of the switch to 192.168.10.200/255.255.255.0.

Previous Next

## 8. Después de seleccionar **TRENDnet Hive**, haga clic en **Next** (Siguiente) y cambie la configuración del adaptador de red de su ordenador para obtener una dirección IP automáticamente para así continuar con el asistente de configuración.

**Nota:** Después de seleccionar la opción TRENDnet Hive y hacer clic en **Next** (Siguiente), el switch cambiará inmediatamente la configuración de la dirección IP por defecto del switch a DHCP y obtendrá la configuración de la dirección IP de su red existente.

Previous Next

## 9. Seleccione su **Time Zone** (Horaria Zona), y después haga clic en **Next** (Siguiente).

Switch Setup Wizard

Step 3: Date/Time Settings

Current Time 03 Dec 2021 14:34:48

Time Zone (GMT-08:00) Pacific Time (US & Canada); Tijuana

Previous Next Cancel

10. Introduzca las credenciales de la cuenta de usuario de su cuenta de TRENDnet Hive Cloud Management para registrar el switch con su cuenta y, a continuación, haga clic en **Next** (Siguiente).

The screenshot shows a web form titled "Switch Setup Wizard" with a sub-header "Step 4: Input your Hive credentials to sync the switch to your Hive account." Below the header are two input fields: "Username" with the text "XXXXXXXXXX" and "Password" with a masked password "\*\*\*\*\*". At the bottom of the form are three buttons: "Previous", "Next", and "Cancel".

11. La página de resumen mostrará todos los ajustes de configuración que se aplicaron a través del asistente de configuración. Haga clic en **Apply** (Aplicar) para completar el asistente de configuración.

**Nota:** Puede anotar la nueva contraseña y la configuración de la dirección IP para el acceso de gestión local al switch.

The screenshot shows a web form titled "Switch Setup Wizard" with a sub-header "System Information". Below the header is a note: "Write down the below information and store it in a safe place. The below information are the current settings that will be applied to the switch. Click **Apply** below to finalize the settings." Below the note is a table of system information:

System Time	03 Dec 2021 14:28:23
Username	admin
Password	*****
Switch IP Address	192.168.10.200
Subnet Mask	255.255.255.0
Gateway IP Address	192.168.10.254
DNS	8.8.8.8

At the bottom of the form are three buttons: "Previous", "Apply", and "Cancel".

12. Para verificar que el switch se ha registrado con éxito en su cuenta de TRENDnet Hive Cloud Management, el botón Hive de la parte superior derecha será verde para indicar que el registro se ha realizado correctamente.



## Sección B: Configurar el switch para la gestión de la red local

1. Conecte un cable Ethernet/de red a su ordenador y a uno de los puertos del switch.

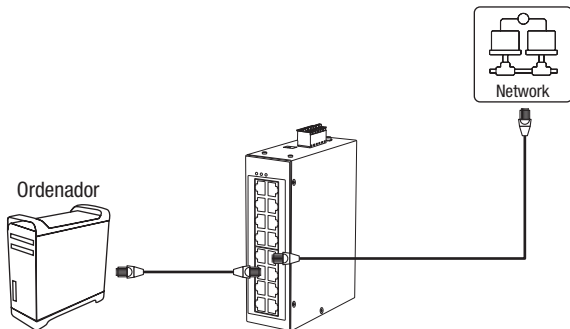

2. Asigne una dirección IP estática al adaptador de red de su ordenador en la máscara de subred de 192.168.10.x (e.j. 192.168.10.25) y máscara de subred de 255.255.255.0.
3. Abra su navegador Web, escriba la dirección IP del switch en la barra de dirección, y luego pulse **Enter** (Intro). La dirección IP por defecto es 192.168.10.200 / 255.255.255.0.

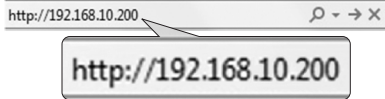

4. Haga clic en **Next** (Siguiente) en el Switch Setup Wizard (Asistente de configuración del switch).

**Nota:** Si no aparece el asistente de configuración del switch, puede hacer clic en el botón del asistente de configuración  en la sección superior derecha de la página de gestión del switch para acceder al asistente de configuración del switch.



5. Puede cambiar la contraseña del administrador del switch escribiendo la nueva contraseña en los campos proporcionados, luego haga clic en **Next** (Siguiente).

**Nota:** Si introduce una nueva contraseña, tenga en cuenta que deberá utilizarla cuando inicie sesión en la página de gestión del switch para acceder a la gestión local.

Switch Setup Wizard

Step 1: Change your login credentials

Username

Password  (Maximum length is 20)

Confirm Password

6. Para el método de gestión, seleccione **Default Management** (Gestión predeterminada).

Switch Setup Wizard

Step 2: Select the method of management for this switch

**TRENDnet Hive:** Choose this option if you would like to manage your switch through TRENDnet's Cloud Management. This option will automatically apply a DHCP connection (Dynamic IP Address) to your switch.  
**Note:** You will need a TRENDnet Hive account with a valid license to complete setup with this process. Choosing this option will prompt an immediate re-login to the device management page.

**Default Management:** Choose this option if you would like to manage your switch through the GUI. You may opt in to use TRENDnet Hive at a later date. Please note, this will set the IP of the switch to 192.168.10.200/255.255.255.0.

7. Configure los ajustes de fecha y hora del switch y, a continuación, haga clic en **Next** (Siguiente).

Switch Setup Wizard

Step 3: Date/Time Settings

Current Time 06 Dec 2021 13:37:33

Date Settings 2021 / 12 / 05 (YYYYMMDD)

Time Settings 13 : 37 : 33 (HH:MM:SS)

8. Configure la dirección IP del switch, la máscara de subred, la dirección IP de la pasarela y los ajustes de DNS para que coincidan con los requisitos de su red existente utilizando los campos proporcionados y, a continuación, haga clic en **Next** (Siguiente).

**Nota:** Si la configuración de la dirección IP del switch se cambia a una subred IP diferente, como 192.168.1.x, 192.168.2.x, etc., será necesario cambiar la configuración del adaptador de red de su ordenador para que coincida con la nueva dirección IP configurada en el switch para poder acceder a la página de gestión del switch.

Switch Setup Wizard	
Step 4: Input your IP settings in the fields below	
IP Address	192.168.10.200
Subnet Mask	255.255.255.0
Gateway IP Address	0.0.0.0
DNS	0.0.0.0
Previous Next Cancel	

9. La página de resumen mostrará todos los ajustes de configuración que se aplicaron a través del asistente de configuración. Haga clic en **Apply** (Aplicar) para completar el asistente de configuración.

**Nota:** Puede anotar la nueva contraseña y la configuración de la dirección IP para el acceso de gestión local al switch.

Switch Setup Wizard	
System Information	
Write down the below information and store it in a safe place. The below information are the current settings that will be applied to the switch. Click <b>Apply</b> below to finalize the settings.	
System Time	08 Dec 2021 13:42:09
Username	admin
Password	*****
Switch IP Address	192.168.10.200
Subnet Mask	255.255.255.0
Gateway IP Address	0.0.0.0
DNS	0.0.0.0
Previous Apply Cancel	

**Nota:** Para descargar la última versión de la guía del usuario, visite: <https://www.trendnet.com/support> y seleccione el **Switch Model**, en la lista desplegable Product Download (descarga de productos).

## 1. Antes de começar

### Conteúdo da embalagem

- TI-G642i/TI-G102i/TI-G160i
- Guia de instalação rápida
- Cabo de console

### Requisitos mínimos

- Fonte de alimentação (ex. Modelos: TI-M6024)
- Computador em rede
- Cabo de rede RJ-45

### Equipamentos opcionais

- Trilho DIN 35 mm
- Módulos SFP (por exemplo, TI-MGBSX, TI-MGBS10, TI-MGB520, TI-MGBS40, TI-MGBRJ)

## 2. Consulta rápida

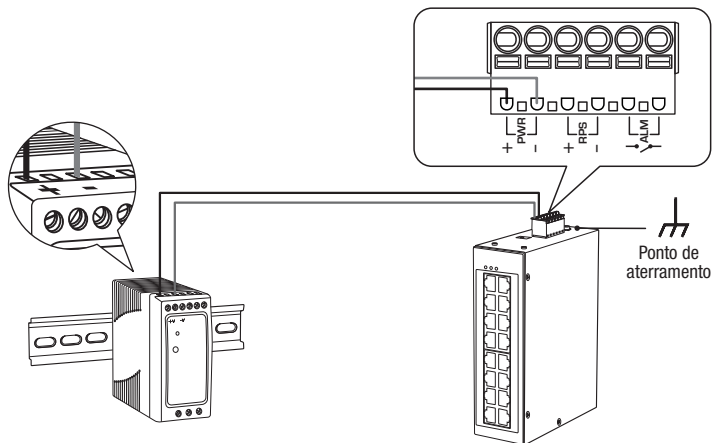

**Nota:** O modelo de switch pode ser diferente do exemplo mostrado abaixo.

### 3. Instalação do hardware

O switch pode ser colocado sobre uma mesa, na parede ou montado em um trilho DIN.

#### Instruções de montagem em trilho DIN

1. Fixe o suporte do trilho DIN no switch.

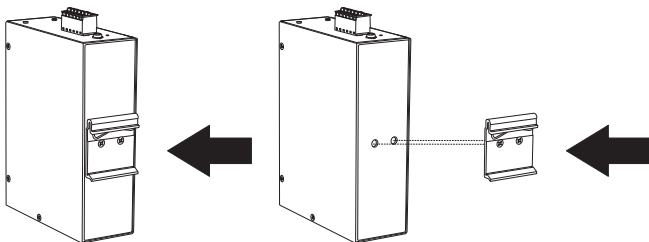

2. Posicione a unidade na frente do trilho DIN e enganche o suporte de montagem na parte superior do trilho.

3. Gire o switch para baixo na direção do trilho para travá-lo no local adequado. Você saberá que ele está seguro quando ouvir um clique.

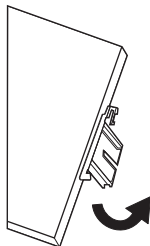

**Montagem da unidade**

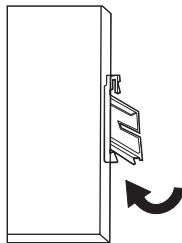

**Liberação da unidade**

4. Para remover a unidade, pressione para baixo para afastar a parte inferior do trilho DIN e gire, afastando-a do trilho.



## Aplicação de energia

**Nota:** Não conecte a fonte de alimentação a uma fonte de energia até que as conexões dos terminais estejam fixadas de acordo com as etapas abaixo.

1. Conecte a fonte de alimentação (vendida separadamente) ao bloco de terminais incluído (como exibido abaixo) e fixe com parafusos.

**Nota:** As polaridades devem coincidir.

2. Fixe o bloco de terminais na unidade, conecte o fio neutro ao aterramento e a fonte de alimentação ao adaptador de energia.

**Opcional:** o chassi do switch também pode ser conectado a um ponto de aterramento conhecido para se obter segurança e proteção adicionais (fio de aterramento não incluído).

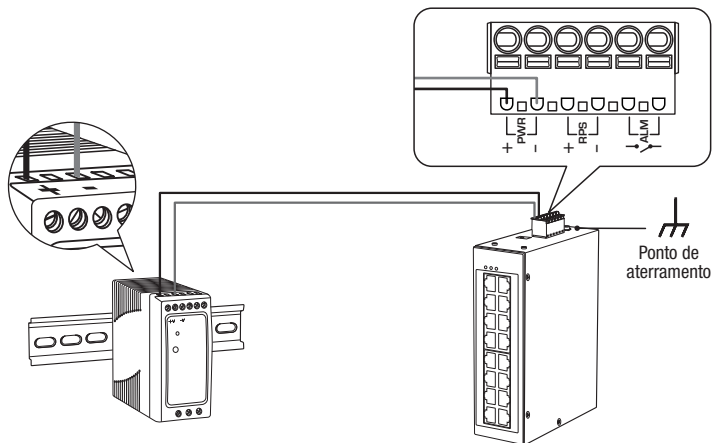

## Nota de segurança



- Desligue a energia antes de conectar qualquer módulo ou fio. A tensão correta da fonte de alimentação está indicada na etiqueta do produto. Verifique a tensão de sua fonte de energia para certificar-se de que está usando a peça correta. NÃO use uma tensão maior do que a gama de voltagem conforme especificado na etiqueta do produto.
- Calcule a corrente máxima possível em cada fio de energia e fio comum. Siga todos os códigos elétricos que ditam a corrente máxima permitível para cada bitola de fio. Se a corrente ultrapassar a classificação máxima, a fiação pode superaquecer causando sérios danos ao seu equipamento.

## 4. Instalação de Hardware e Configuração

**Nota:** Se você estiver configurando o switch a ser gerenciada a partir de sua conta TRENDnet Hive Cloud, siga os passos na Seção A: Configurando o switch com TRENDnet Hive Cloud Management. Se você estiver configurando o switch apenas para gerenciamento da rede local, siga os passos da Seção B: Configurando o switch para gerenciamento da rede local.

### Seção A: Configurando o switch com o TRENDnet Hive Cloud Management

**Nota:** A configuração com TRENDnet Hive Cloud Management requer uma rede existente com acesso à Internet e servidor DHCP para endereçamento IP automático. O switch deve ser configurado para acessar a Internet a fim de se conectar à sua conta TRENDnet Hive Cloud Management.

1. Conecte um cabo Ethernet/redes ao seu computador e uma das portas do switch.
2. Conecte outro cabo Ethernet/rede a uma das portas do switch e a sua rede ou roteador existente com acesso à Internet e servidor DHCP para endereçamento IP automático.

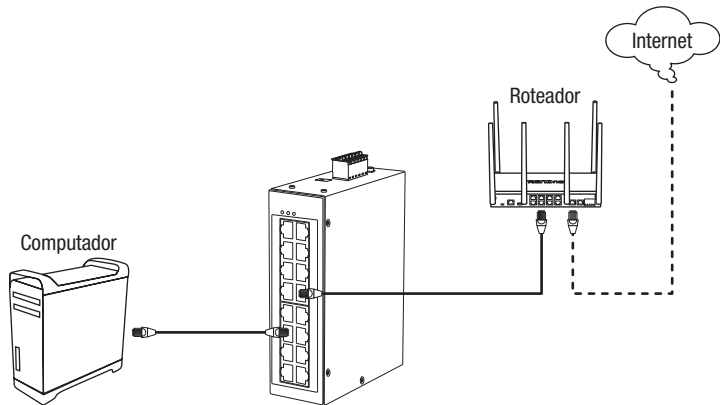

3. Colocar um endereço IP estático, na placa de rede do seu computador, na gama de Ips 192.168.10.x (por exemplo: 192.168.10.25) e colocar no campo da subnet mask 255.255.255.0.
4. Abra seu web browser, digite endereço IP do switch na barra de endereços e então pressione **Enter**. O endereço IP padrão é 192.168.10.200 / 255.255.255.0.

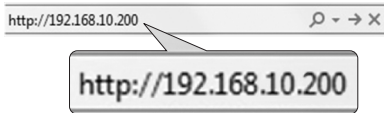

5. Clique em **Next** (Avançar) no Switch Setup Wizard (Assistente de Configuração do Switch).

**Nota:** Se o assistente de configuração do switch não aparecer, você pode clicar no botão  o assistente de configuração na seção superior direita da página de gerenciamento do switch para acessar o assistente de configuração do switch.



6. Você pode alterar a senha do administrador do switch digitando a nova senha nos campos fornecidos e, em seguida, clique em **Next** (Avançar).

**Nota:** Se estiver inserindo uma nova senha, por favor, note que você precisará usar a nova senha ao entrar na página de gerenciamento do switch para que o acesso de gerenciamento local avance.



7. Para o método de gerenciamento, selecione **TRENDnet Hive**.

**Nota:** A configuração com TRENDnet Hive Cloud Management requer uma rede existente com acesso à Internet e servidor DHCP para endereçamento IP automático. O switch deve ser configurado para acessar a Internet a fim de se conectar à sua conta TRENDnet Hive Cloud Management. Se o switch não conseguir alcançar as configurações de endereço IP e DNS do servidor DHCP e não conseguir acessar a Internet, o registro do switch em sua conta TRENDnet Hive Cloud Management irá falhar.

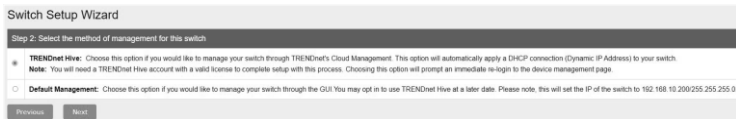

Switch Setup Wizard

Step 2: Select the method of management for this switch

**TRENDnet Hive.** Choose this option if you would like to manage your switch through TRENDnet's Cloud Management. This option will automatically apply a DHCP connection (Dynamic IP Address) to your switch.  
**Note:** You will need a TRENDnet Hive account with a valid license to complete setup with this process. Choosing this option will prompt an immediate re-login to the device management page.

**Default Management.** Choose this option if you would like to manage your switch through the GUI. You may opt in to use TRENDnet Hive at a later date. Please note, this will set the IP of the switch to 192.168.10.200/255.255.255.0.

Previous Next

8. Após selecionar **TRENDnet Hive**, clique em **Next** (Avançar) e altere as configurações do adaptador de rede de seu computador para obter um endereço IP automaticamente para continuar com o assistente de configuração.

**Nota:** Após selecionar a opção TRENDnet Hive e clicar em **Next** (Avançar), o switch alterará imediatamente as configurações de endereço IP padrão do switch para DHCP e obterá as configurações de endereço IP de sua rede existente.



Previous Next

9. Selecione seu **Time Zone** (Fuso Horário), depois clique em **Next** (Avançar).



Switch Setup Wizard

Step 3: Date/Time Settings

Current Time 03 Dec 2021 14:34:48

Time Zone (GMT-08:00) Pacific Time (US & Canada); Tijuana

Previous Next Cancel

10. Digite as credenciais de conta de usuário para sua conta TRENDnet Hive Cloud Management para registrar a switch com sua conta, depois clique em **Next** (Avançar).

Switch Setup Wizard

Step 4: Input your Hive credentials to sync the switch to your Hive account.

Username	XXXXXXXXXX
Password	*****

Previous Next Cancel

11. A página de resumo exibirá todas as configurações que foram aplicadas através do assistente de configuração. Clique em **Apply** (Aplicar) para completar o assistente de configuração.

**Nota:** Você pode querer anotar as novas configurações de senha e endereço IP para o acessar a gerência local do switch.

Switch Setup Wizard

System Information

Write down the below information and store it in a safe place. The below information are the current settings that will be applied to the switch. Click **Apply** below to finalize the settings.

System Time	03 Dec 2021 14:28:23
Username	admin
Password	*****
Switch IP Address	192.168.10.200
Subnet Mask	255.255.255.0
Gateway IP Address	192.168.10.254
DNS	8.8.8.8

Previous Apply Cancel

12. Para verificar se o switch está agora registrado com sucesso em sua conta TRENDnet Hive Cloud Management, o botão Hive no canto superior direito estará verde para indicar o registro bem-sucedido.



## Seção B: Configurando o switch para o gerenciamento da rede local

1. Conecte um cabo Ethernet/redes ao seu computador e uma das portas do switch.

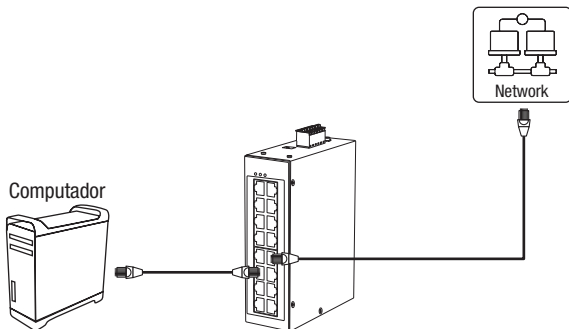

2. Colocar um endereço IP estático, na placa de rede do seu computador, na gama de Ips 192.168.10.x (por exemplo: 192.168.10.25) e colocar no campo da subnet mask 255.255.255.0.
3. Abra seu web browser, digite endereço IP do switch na barra de endereços e então pressione **Enter**. O endereço IP padrão é 192.168.10.200 / 255.255.255.0.

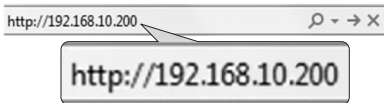

4. Clique em **Next** (Avançar) no Switch Setup Wizard (Assistente de Configuração do Switch).

**Nota:** Se o assistente de configuração do switch não aparecer, você pode clicar no botão  do assistente de configuração na seção superior direita da página de gerenciamento do switch para acessar o assistente de configuração do switch.

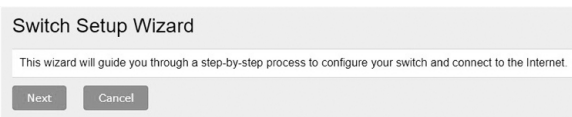

5. Você pode alterar a senha do administrador do switch digitando a nova senha nos campos fornecidos e, em seguida, clique em **Next** (Avançar).

**Nota:** Se estiver inserindo uma nova senha, por favor, note que você precisará usar a nova senha ao entrar na página de gerenciamento do switch para que o acesso de gerenciamento local avance.

Switch Setup Wizard

Step 1: Change your login credentials

Username	admin	
Password		(Maximum length is 20)
Confirm Password		

Previous Next Cancel

6. Para o método de gerenciamento, selecione **Default Management** (Gestão padrão).

Switch Setup Wizard

Step 2: Select the method of management for this switch

**TRENDnet Hive:** Choose this option if you would like to manage your switch through TRENDnet's Cloud Management. This option will automatically apply a DHCP connection (Dynamic IP Address) to your switch.  
**Note:** You will need a TRENDnet Hive account with a valid license to complete setup with this process. Choosing this option will prompt an immediate re-login to the device management page.

**Default Management:** Choose this option if you would like to manage your switch through the GUI. You may opt in to use TRENDnet Hive at a later date. Please note, this will set the IP of the switch to 192.168.10.200/255.255.255.0.

Previous Next

7. Configure as configurações de data e hora do switch e, em seguida, clique em **Next** (Avançar).

Switch Setup Wizard

Step 3: Date/Time Settings

Current Time	08 Dec 2021 13:37:33		
Date Settings	2021	/ 12	/ 08 (YYYYMMDD)
Time Settings	13	: 37	: 33 (HHMMSS)

Previous Next Cancel



8. Configure o endereço IP do switch, máscara de sub-rede, endereço IP do gateway e configurações de DNS para corresponder aos requisitos de sua rede existente usando os campos fornecidos e, em seguida, clique em **Next** (Avançar).

**Nota:** Se as configurações do endereço IP do switch forem alteradas para uma sub-rede de rede IP diferente, como 192.168.1.x, 192.168.2.x, etc., as configurações do adaptador de rede de seu computador precisarão ser alteradas para corresponder às novas configurações de endereço IP configuradas no switch, a fim de acessar a página de gerenciamento do switch.

Switch Setup Wizard	
Step 4: Input your IP settings in the fields below	
IP Address	192.168.10.200
Subnet Mask	255.255.255.0
Gateway IP Address	0.0.0.0
DNS	0.0.0.0
Previous Next Cancel	

9. A página de resumo exibirá todas as configurações que foram aplicadas através do assistente de configuração. Clique em **Apply** (Aplicar) para completar o assistente de configuração.

**Nota:** Você pode querer anotar as novas configurações de senha e endereço IP para o acessar a gerência local do switch.

Switch Setup Wizard	
System Information	
Write down the below information and store it in a safe place. The below information are the current settings that will be applied to the switch. Click <b>Apply</b> below to finalize the settings.	
System Time	08 Dec 2021 13:42:09
Username	admin
Password	*****
Switch IP Address	192.168.10.200
Subnet Mask	255.255.255.0
Gateway IP Address	0.0.0.0
DNS	0.0.0.0
Previous Apply Cancel	

**Nota:** Para fazer o download da versão mais recente do guia do usuário, acesse: <https://www.trendnet.com/support> e selecione o **Switch Model** na lista suspensa Download do Produto.

## 1. Prima di cominciare

### Contenuto della confezione

- TI-G642i/TI-G102i/TI-G160i
- Guida rapida d'installazione
- Cavo console

### Requisiti minimi

- Alimentazione (es. Modelli: TI-M6024)
- Computer connessi in rete
- Cavo di rete RJ-45

### Apparecchiature opzionali

- Guida DIN 35 mm
- Moduli SFP (ad es. TI-MGBSX, TI-MGBS10, TI-MGB520, TI-MGBS40, TI-MGBRJ)

## 2. Riferimento rapido

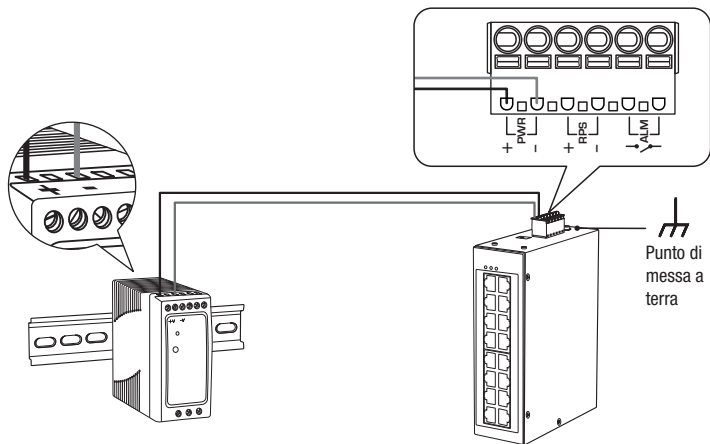

**Nota:** Il modello di switch (commutatore) potrebbe essere diverso da quello mostrato nell'esempio seguente.

### 3. Installazione hardware

Il switch può essere posizionato su un desktop, parete o montato su un DIN-Rail.

#### Istruzioni per il montaggio DIN-Rail

1. Collegare la staffa DIN-Rail al switch.

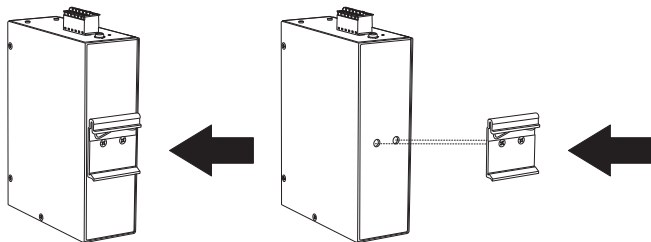

2. Posizionare l'unità di fronte al DIN-Rail e agganciare la staffa di montaggio sopra la parte superiore del binario.
3. Ruotare il switch verso il basso in direzione del binario e bloccarlo in posizione. Il dispositivo sarà fissato in sicurezza quando sentirete un clic.

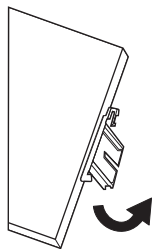

**Montaggio dell'unità**

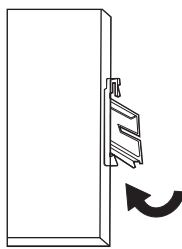

**Rilascio dell'unità**

4. Per rimuovere l'unità, spingere per liberare la parte inferiore del DIN-Rail e ruotare per allontanare dal binario.

## Applicazione potenza

**Nota:** Non collegare l'alimentatore a una fonte di alimentazione fino a quando i collegamenti dei terminali non sono stati serrati con i passaggi indicati di seguito.

1. Collegare l'alimentatore (venduto separatamente) alla morsettieria inclusa (come mostrato sotto) e assicurare con le viti.

**Nota:** Le polarità devono corrispondere

2. Attaccare la morsettieria all'unità, collegare il cavo neutro alla terra e l'alimentatore all'adattatore.

**Opzionale:** lo switch classico può anche essere collegato a un punto di messa a terra conosciuto per una sicurezza e protezione aggiuntive (cavo di messa a terra non incluso).

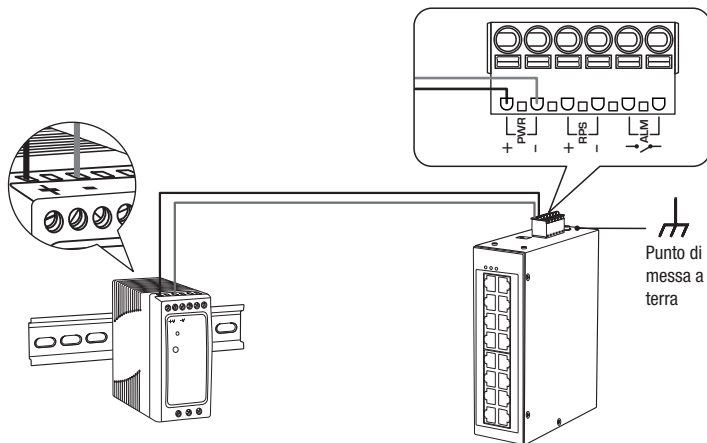

## Nota di sicurezza



- Spegnere l'alimentazione prima di collegare qualsiasi modulo o filo. La corretta tensione di alimentazione è elencata sull'etichetta del prodotto. Controllare il voltaggio della propria fonte di alimentazione per accertarsi di stare usando la parte corretta. Non utilizzare un voltaggio superiore a l'intervallo di tensione come specificato sull'etichetta del prodotto.
- Calcolare la massima corrente possibile in ciascun cavo di alimentazione e cavo comune. Osservare tutti i codici elettrici che raccomandano la corrente massima disponibile per ciascuna dimensione del filo. Se la corrente supera la tensione nominale massima, il cablaggio potrebbe surriscaldarsi, causando seri danni alla vostra apparecchiatura.

## 4. Installazione e configurazione Hardware

**Nota:** Se si sta configurando lo switch per essere gestito dal proprio account cloud TRENDnet Hive esistente, seguire i passaggi indicati nella Sezione A: Configurazione dello switch con TRENDnet Hive Cloud Management. Se si sta configurando lo switch solo per la gestione della rete locale, seguire i passaggi indicati nella Sezione B: Configurazione dello switch per la gestione della rete locale.

### **Sezione A: Configurazione dello switch con TRENDnet Hive Cloud Management**

**Nota:** La configurazione con TRENDnet Hive Cloud Management richiede una rete esistente con accesso Internet e un server DHCP per l'indirizzamento IP automatico. Lo switch deve essere configurato per accedere a Internet al fine di connettersi al proprio account TRENDnet Hive Cloud Management.

1. Collegare un cavo Ethernet/di rete al computer e a una delle porte dello switch.
2. Collegare un altro cavo Ethernet/di rete a una delle porte dello switch e alla rete esistente o al router con accesso a Internet e server DHCP per l'indirizzamento IP automatico.

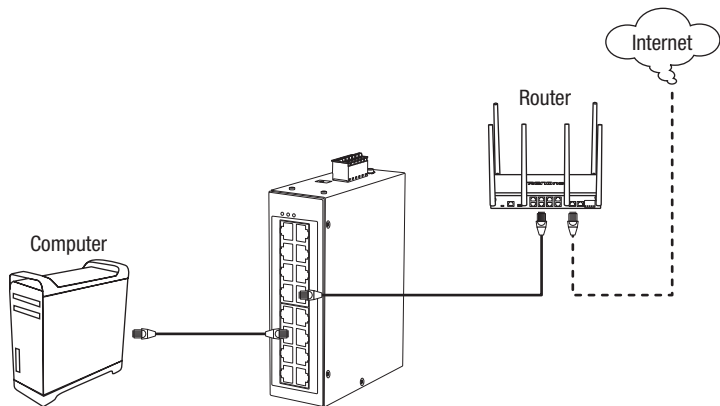

3. Assignare un indirizzo IP statico alla scheda di rete del proprio computer nella sottorete 192.168.10.x (e.g. 192.168.10.25) con subnet mask 255.255.255.0.
4. Aprire il web browser, digitare l'indirizzo IP dello switch nella barra indirizzi e premere **Enter** (Invio). L'indirizzo IP di fabbrica è 192.168.10.200 / 255.255.255.0.

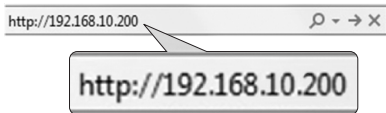

5. Cliccare su **Next** (Avanti) su Switch Setup Wizard (procedura guidata di configurazione switch).

**Nota:** Se lo switch setup wizard non si visualizza, è possibile cliccare sul pulsante setup wizard  nella sezione in alto a destra della pagina di gestione dello switch per accedervi.



6. È possibile cambiare la password amministratore dello switch digitando la nuova password nei campi appositi, quindi cliccare su **Next** (Avanti).

**Nota:** Se si inserisce una nuova password, occorre tenere presente che sarà necessario utilizzarla quando si accede alla pagina di gestione dello switch per l'accesso, in futuro, alla gestione in locale.



7. Per la modalità di gestione, selezionare **TRENDnet Hive**.

**Nota:** La configurazione con TRENDnet Hive Cloud Management richiede una rete preesistente con accesso a Internet e un server DHCP per l'indirizzamento IP automatico. Lo switch deve essere configurato per accedere a Internet al fine di connettersi al proprio account TRENDnet Hive Cloud Management. Se lo switch non è in grado di comunicare per ottenere le impostazioni di indirizzo IP e DNS dal server DHCP e non è in grado di accedere a Internet, la registrazione dello switch al proprio account TRENDnet Hive Cloud Management non può avvenire con successo.

Switch Setup Wizard

Step 2: Select the method of management for this switch

**TRENDnet Hive:** Choose this option if you would like to manage your switch through TRENDnet's Cloud Management. This option will automatically apply a DHCP connection (Dynamic IP Address) to your switch.  
**Note:** You will need a TRENDnet Hive account with a valid license to complete setup with this process. Choosing this option will prompt an immediate re-login to the device management page.

**Default Management:** Choose this option if you would like to manage your switch through the GUI. You may opt in to use TRENDnet Hive at a later date. Please note, this will set the IP of the switch to 192.168.10.200/255.255.255.0.

Previous Next

8. Dopo aver selezionato **TRENDnet Hive**, cliccare su **Next** (Avanti) e cambiare le impostazioni dell'adattatore di rete del computer al fine di ottenere automaticamente un indirizzo IP per proseguire la procedura guidata di installazione.

**Nota:** Dopo aver selezionato l'opzione TRENDnet Hive e aver cliccato su **Next** (Avanti) , lo switch cambierà immediatamente le impostazioni dell'indirizzo IP di default nel DHCP e otterrà le impostazioni dell'indirizzo IP dalla rete esistente.



9. Selezionare la propria **Time Zone** (Fuso Horário), quindi cliccare su **Next** (Avanti).

Switch Setup Wizard

Step 3: Date/Time Settings

Current Time 03 Dec 2021 14:34:48

Time Zone (GMT-08:00) Pacific Time (US & Canada), Yaguana

Previous Next Cancel



10. Inserire le credenziali dell'account utente per il proprio account TRENDnet Hive Cloud Management per registrare lo switch con il proprio account, quindi fare clic su **Next** (Avanti).

Switch Setup Wizard

Step 4: Input your Hive credentials to sync the switch to your Hive account.

Username: XXXXXXXXXXXX

Password: \*\*\*\*\*

Previous Next Cancel

11. La pagina di riepilogo mostrerà tutte le impostazioni di configurazione che sono state applicate attraverso la procedura guidata di configurazione. Cliccare su **Apply** (Applica) per completare l'installazione guidata.

**Nota:** Si consiglia di annotare la nuova password e le impostazioni dell'indirizzo IP per l'accesso alla gestione locale dello switch.

Switch Setup Wizard

System Information

Write down the below information and store it in a safe place. The below information are the current settings that will be applied to the switch. Click Apply below to finalize the settings.

System Time	03 Dec 2021 14:28:23
Username	admin
Password	*****
Switch IP Address	192.168.10.200
Subnet Mask	255.255.255.0
Gateway IP Address	192.168.10.254
DNS	8.8.8.8

Previous Apply Cancel

12. Al fine di verificare che lo switch sia ora registrato con successo con il proprio account TRENDnet Hive Cloud Management, il pulsante Hive in alto a destra sarà di colore verde per indicare una registrazione riuscita.



## Sezione B: Configurazione dello switch per la gestione della rete in locale

1. Collegare un cavo Ethernet/di rete al computer e a una delle porte dello switch.

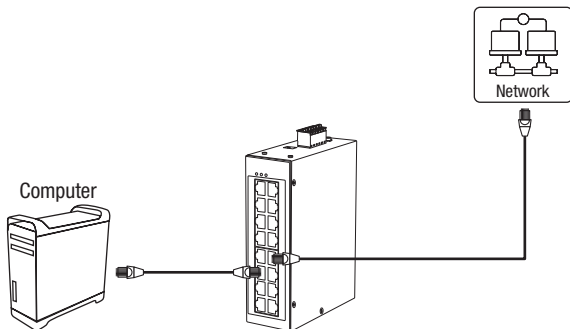

2. Assignare un indirizzo IP statico alla scheda di rete del proprio computer nella sottorete 192.168.10.x (e.g. 192.168.10.25) con subnet mask 255.255.255.0.
3. Aprire il web browser, digitare l'indirizzo IP dello switch nella barra indirizzi e premere **Enter** (Invio). L'indirizzo IP di fabbrica è 192.168.10.200 / 255.255.255.0.

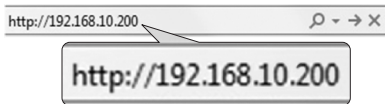

4. Cliccare su **Next** (Avanti) su Switch Setup Wizard (procedura guidata di configurazione switch).

**Nota:** Se lo switch setup wizard non si visualizza, è possibile cliccare sul pulsante setup wizard  nella sezione in alto a destra della pagina di gestione dello switch per accedervi.



5. È possibile cambiare la password amministratore dello switch digitando la nuova password nei campi appositi, quindi cliccare su **Next** (Avanti).

**Nota:** Se si inserisce una nuova password, occorre tenere presente che sarà necessario utilizzarla quando si accede alla pagina di gestione dello switch per l'accesso, in futuro, alla gestione in locale.

Switch Setup Wizard

Step 1: Change your login credentials

Username

Password  (Maximum length is 20)

Confirm Password

6. Per la modalità di gestione, selezionare **Default Management** (Gestione predefinita).

Switch Setup Wizard

Step 2: Select the method of management for this switch

**TRENDnet Hive:** Choose this option if you would like to manage your switch through TRENDnet's Cloud Management. This option will automatically apply a DHCP connection (Dynamic IP Address) to your switch.  
**Note:** You will need a TRENDnet Hive account with a valid license to complete setup with this process. Choosing this option will prompt an immediate re-login to the device management page.

**Default Management:** Choose this option if you would like to manage your switch through the GUI. You may opt in to use TRENDnet Hive at a later date. Please note, this will set the IP of the switch to 192.168.10.200/255.255.255.0.

7. Configurare le impostazioni di data e ora dello switch, quindi cliccare su **Next** (Avanti).

Switch Setup Wizard

Step 3: Date/Time Settings

Current Time 08 Dec 2021 13:37:33

Date Settings 2021 / 12 / 08 (YYYYMMDD)

Time Settings 13 : 37 : 33 (HHMMSS)

8. Configurare, utilizzando i campi previsti, l'indirizzo IP dello switch, la subnet mask, l'indirizzo IP del gateway e le impostazioni DNS in modo che corrispondano ai requisiti della tua rete esistente, quindi cliccare su **Next** (Avanti).

**Nota:** Se le impostazioni dell'indirizzo IP dello switch sono cambiate in una subnet di rete IP diversa come 192.168.1.x, 192.168.2.x, ecc. le impostazioni dell'adattatore di rete del computer dovranno essere modificate in modo tale da allinearsi alle nuove impostazioni di indirizzo IP configurate sullo switch per poter accedere alla pagina di gestione dello stesso.

Switch Setup Wizard	
Step 4: Input your IP settings in the fields below	
IP Address	192.168.10.200
Subnet Mask	255.255.255.0
Gateway IP Address	0.0.0.0
DNS	0.0.0.0
Previous Next Cancel	

9. La pagina di riepilogo mostrerà tutte le impostazioni di configurazione che sono state applicate attraverso la procedura guidata di configurazione. Cliccare su **Apply** (Applica) per completare l'installazione guidata.

**Nota:** Si consiglia di annotare la nuova password e le impostazioni dell'indirizzo IP per l'accesso alla gestione locale dello switch.

Switch Setup Wizard	
System Information	
Write down the below information and store it in a safe place. The below information are the current settings that will be applied to the switch. Click <b>Apply</b> below to finalize the settings.	
System Time	08 Dec 2021 13:42:09
Username	admin
Password	*****
Switch IP Address	192.168.10.200
Subnet Mask	255.255.255.0
Gateway IP Address	0.0.0.0
DNS	0.0.0.0
Previous Apply Cancel	

**Nota:** Per scaricare la versione più recente della guida utente, andare su: <https://www.trendnet.com/support> e selezionare il **Switch Model** all'interno dell'elenco a discesa Download Prodotto.

# Declaration of Conformity

TRENDNET®

## Manufacturer's Name and Address

TRENDnet, Inc. Zwolsestraat 156 2587 WB  
20675 Manhattan Place The Hague The  
Torrance, CA 90501 USA Netherlands



## Product Information:

**Model Number:** TI-G642i / TI-G102i / TI-G160i  
**Product Name:** 6-Port Industrial Gigabit L2 Managed DIN-Rail Switch  
10-Port Industrial Gigabit L2 Managed DIN-Rail Switch  
16-port Industrial Gigabit L2 Managed DIN-Rail Switch  
**Trade Name:** TRENDnet

TRENDnet hereby declare that the product is in compliance with the essential requirements and other relevant provisions under our sole responsibility.

**EMC** EN 55032: 2015 + A11: 2020  
EN 55035: 2017 + A11: 2020  
EN 55011: 2016 + A11: 2020 Group 1 Class A (TI-G160i)  
EN 61000-6-2: 2019 (TI-G160i)  
EN 61000-6-4: 2019 (TI-G160i)  
CISPR 32: 2015 + COR1: 2016  
ISED: ICES-003, ISSUE 7

This product is herewith confirmed to comply with the Directives.

**Directives:** EMC Directive 2014/30/EU  
RoHS Directive 2011/65/EU  
RoHS 3 Directive 2015/863/EU  
REACH Regulation (EU) no. 1907/2006  
WEEE Regulation 2012/19/EU

Person responsible for this declaration.

Place of Issue: Torrance, California, USA

Date: March 31, 2025

Name: Sonny Su

Title: VP of Technology

Signature: \_\_\_\_\_

A handwritten signature in black ink, appearing to read 'Sonny Su', is written over a horizontal line.



# Déclaration de conformité

TRENDNET®

## Nom et adresse du fabricant

TRENDnet, Inc. Zwolsestraat 156 2587 WB  
20675 Manhattan Place The Hague The  
Torrance, CA 90501 USA Netherlands



## Détails du produit:

**Modèle:** TI-G642i / TI-G102i / TI-G160i

**Nom du produit:** Switch rail DIN industriel administrable L2 Gigabit à 6 ports  
Switch rail DIN industriel administrable L2 Gigabit à 10 ports  
Switch rail DIN industriel administrable L2 Managed à 16 ports

**Nom Commercial:** TRENDnet

TRENDnet déclare par la présente que le produit est conforme aux exigences essentielles et aux autres dispositions pertinentes de la Directive en vertu de notre seule responsabilité.

**CEM** EN 55032: 2015 + A11: 2020  
EN 55035: 2017 + A11: 2020  
EN 55011: 2016 + A11: 2020 Group 1 Class A (TI-G160i)  
EN 61000-6-2: 2019 (TI-G160i)  
EN 61000-6-4: 2019 (TI-G160i)  
CISPR 32: 2015 + COR1: 2016  
ISED: ICES-003, ISSUE 7

Ce produit est conforme à la directives suivante.

**Directives:** Directive CEM 2014/30/EU  
Directive 2015/863/UE (RoHS 3)  
Directive RoHS 2011/65/EU  
REACH Règlement (CE) N° 1907/2006  
Directive WEEE 2012/19/UE

Personne responsable de cette déclaration.

Lieu de délivrance: Torrance, California, USA

Date: 31 Mars, 2025

Nom: Sonny Su

Position: Vice-président de Technologie

Signature:



# Konformitätserklärung

TRENDnet<sup>®</sup>

## Name und Adresse des Herstellers

TRENDnet, Inc. Zwolsestraat 156 2587 WB  
20675 Manhattan Place The Hague The  
Torrance, CA 90501 USA Netherlands



## Informationen zum Produkt

**Modellnummer:** TI-G642i / TI-G102i / TI-G160i  
**Produktname:** 6-Port industrieller Gigabit L2 Managed DIN-Rail-Switch  
10-Port industrieller Gigabit L2 verwalteter DIN-Rail-Switch  
16-Port industrieller Gigabit L2 Managed DIN-Rail-Switch

**Handelsname:** TRENDnet

TRENDnet erklärt hiermit, dass das Produkt den grundlegenden Anforderungen und anderen relevanten Bestimmungen unter unserer alleinigen Verantwortung entspricht.

**EMV** EN 55032: 2015 + A11: 2020  
EN 55035: 2017 + A11: 2020  
EN 55011: 2016 + A11: 2020 Group 1 Class A (TI-G160i)  
EN 61000-6-2: 2019 (TI-G160i)  
EN 61000-6-4: 2019 (TI-G160i)  
CISPR 32: 2015 + COR1: 2016  
ISED: ICES-003, ISSUE 7

Hiermit wird bestätigt, dass dieses Produkt den folgenden Richtlinien entspricht.

**Richtlinien:** EMV-Richtlinie 2014/30/EU  
RoHS 3-Richtlinie 2015/863/EU  
RoHS-Richtlinie 2011/65/EU  
REACH-Verordnung (EG) Nr. 1907/2006  
WEEE-Richtlinie 2012/19/EU

Für diese Erklärung verantwortliche Person.

Ort der Ausstellung: Torrance, California, USA

Datum: Mai 31, 2025

Name: Sonny Su

Titel: Vice President of Technology

Unterschrift: \_\_\_\_\_



# Declaration of Conformity

TRENDNET<sup>®</sup>

## Manufacturer's Name and Address

TRENDnet, Inc.  
20675 Manhattan Place  
Torrance, CA 90501 USA

Authorized Representative:  
Office: +44 (0) 1635 887 399  
Unit 4 Rivermead Business Park,  
Pipers Way, Thatcham, RG19 4EP England

UK  
CA

## Product Information:

**Model Number:** TI-G642i / TI-G102i / TI-G160i

**Product Name:** 6-Port Industrial Gigabit L2 Managed DIN-Rail Switch  
10-Port Industrial Gigabit L2 Managed DIN-Rail Switch  
16-port Industrial Gigabit L2 Managed DIN-Rail Switch

**Trade Name:** TRENDnet

TRENDnet hereby declare that the product is in compliance with the essential requirements and other relevant provisions under our sole responsibility.

**EMC** BS EN 55032: 2015 + A11: 2020  
BS EN 55035: 2017 + A11: 2020  
BS EN 55011: 2016 + A11: 2020 Group 1 Class A (TI-G160i)  
BS EN 61000-6-2: 2019 (TI-G160i)  
BS EN 61000-6-4: 2019 (TI-G160i)  
CISPR 32: 2015 + COR1: 2016  
ISED: ICES-003, ISSUE 7

This product is herewith confirmed to comply with the Directives.

**Directives:** Electromagnetic Compatibility Regulations 2016  
The Restriction of the Use of Certain Hazardous Substances in Electrical and Electronic Equipment Regulations 2012  
The REACH Enforcement Regulations 2008 (as amended)  
The Waste Electrical and Electronic Equipment Regulations 2013 (as amended)

Person responsible for this declaration.

Place of Issue: Torrance, California, USA

Date: March 31, 2025

Name: Sonny Su

Title: VP of Technology

Signature: \_\_\_\_\_





## Certifications

This device complies with Part 15 of the FCC Rules. Operation is subject to the following two conditions:  
(1) This device may not cause harmful interference.  
(2) This device must accept any interference received. Including interference that may cause undesired operation.



Waste electrical and electronic products must not be disposed of with household waste. Please recycle where facilities exist. Check with your Local Authority or Retailer for recycling advice.

- This equipment has been tested and found to comply with the limits for a Class A digital device, pursuant to part 15 of the FCC Rules. These limits are designed to provide reasonable protection against harmful interference when the equipment is operated in a commercial environment. This equipment generates, uses, and can radiate radio frequency energy and, if not installed and used in accordance with the instruction manual, may cause harmful interference to radio communications. Operation of this equipment in a residential area is likely to cause harmful interference in which case the user will be required to correct the interference at his own expense.
- FCC Caution: Any changes or modification not expressly approved by the party responsible for compliance could void the user's authority to operate this equipment.

## Technical Support

If you have any questions regarding the product installation, please contact our Technical Support.

Toll free US/Canada: **1-855-373-4741**

Regional phone numbers available at  
[www.trendnet.com/support](http://www.trendnet.com/support)

## TRENDnet

20675 Manhattan Place  
Torrance, CA 90501  
USA

Applies to PoE Products Only: This product is to be connected only to PoE networks without routing to the outside plant.

## Note

The Manufacturer is not responsible for any radio or TV interference caused by unauthorized modifications to this equipment. Such modifications could void the user's authority to operate the equipment.

## Advertencia

En todos nuestros equipos se mencionan claramente las características del adaptador de alimentación necesario para su funcionamiento. El uso de un adaptador distinto al mencionado puede producir daños físicos y/o daños al equipo conectado. El adaptador de alimentación debe operar con voltaje y frecuencia de la energía eléctrica domiciliaria existente en el país o zona de instalación.

## Power supply connected caution

The equipment power supply cord shall be connected to a socket-outlet with earthing connection.

## Advertencia

Le cordon d'alimentation de l'appareil doit être raccordé à une prise de courant avec mise à la terre.

If the Optical Transceiver doesn't ship with the unit, the user manual shall have description as below or equivalent: "This product is intended to be use with a UL Listed Optical Transceiver product, Rated DC3.3V, Laser Class I."

## Product Warranty Registration

Please take a moment to register your product online. Go to TRENDnet's website at: [www.trendnet.com/register](http://www.trendnet.com/register)