

# TRENDNET®



## Quick Installation Guide

### Unmanaged IP50 Industrial Switch (v2.xR)

# Table of Contents

---

Please click on the language below to go to the selected language

## 1 English

1. Before You Start
2. Quick Reference
3. Configuring the switch for local network management

## 10 Français

1. Avant de commencer
2. Références rapides
3. Configurer le switch pour la gestion du réseau local

## 17 Deutsch

1. Bevor Sie Anfangen
2. Schnellübersicht
3. Konfigurieren des Switches für die lokale Netzwerkverwaltung aus

## 24 Español

1. Antes de comenzar
2. Referencia rápida
3. Configurar el switch para la gestión de la red local

## 31 Português

1. Antes de Iniciar
2. Referência Rápida
3. Configurando o switch para o gerenciamento da rede local

## 38 Italiano

1. Prima di cominciare
2. Riferimento rapido
3. Configurazione dello switch per la gestione della rete in locale

<https://www.trendnet.com/qig/1640>



## Safety Note



- Turn off the power before connecting or removing any module or wire. The correct power supply voltage is listed on the product label. Check the voltage of your power source to make sure that you are using the correct part. Do NOT use voltage greater than the maximum listed on the product label.
- Calculate the maximum possible current in each power wire and common wire. Observe all electrical codes dictating the maximum current allowable for each wire size. If the current surpasses the maximum ratings, the wiring could overheat, causing serious damage to your equipment.

# 1. Before You Start

## Package Contents

- TI-E50 / TI-E80 / TI-G50 / TI-G80 / TI-G62
- Quick Installation Guide
- Removable terminal block
- DIN-Rail mount
- Wall mount kit

## Minimum Requirements

- Existing network
- Power Supply

## Power Consumption

Switch Model	Power Consumption	DC Input Voltage Range
TI-E50	5.76W	12 – 56V DC
TI-E80	8W	12 – 56V DC
TI-G50	3W	12 – 56V DC
TI-G80	5W	12 – 56V DC
TI-G62	4.5W	12 – 56V DC

## Power Supplies

Power Supply Model	Max. Power Supplied	DC Output	Type
TI-M6024	60W	24V / 2.5A	DIN-Rail
TI-S12024	120W	24V / 5A	DIN-Rail
TI-S12048	120W	48V / 2.5A	DIN-Rail
TI-S24048	240W	48V / 5A	DIN-Rail
TI-S48048	480W	48V / 10A	DIN-Rail

**Note:** Select the appropriate power supply according to the switch model you have purchased.

## 2. Quick Reference

**Note:** The switch model and power supply may be different than the one shown in the example below.

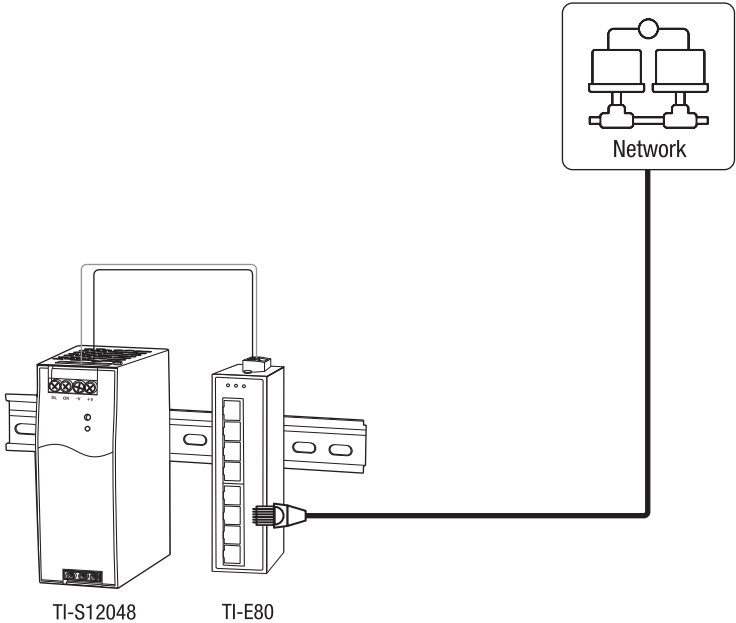

### 3. Hardware Installation

The switch can be placed on a desktop, wall mounted, or mounted to a DIN-Rail.

#### DIN-Rail Mounting Instructions

1. Attach the DIN-rail mount bracket to the switch.

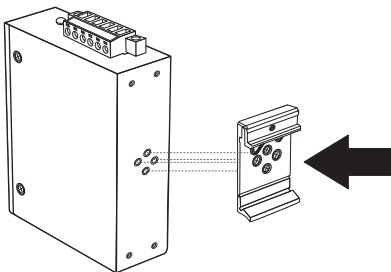

2. Position the unit in front of the DIN-Rail and hook the mount bracket over the top of the rail.
3. Rotate the unit downward towards the rail to lock it into place. You will know it is secure when you hear the click.

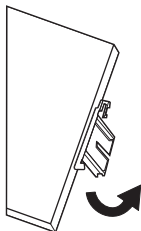

**Mounting the unit**

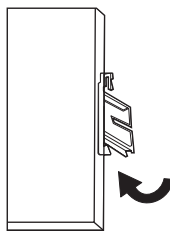

**Releasing the unit**

4. To remove the unit, pull down to clear the bottom of the DIN-Rail and rotate up, away from the rail.

## Wall Mounting Instructions

1. Attach the wall mount plates to switch.
2. Mount the switch.

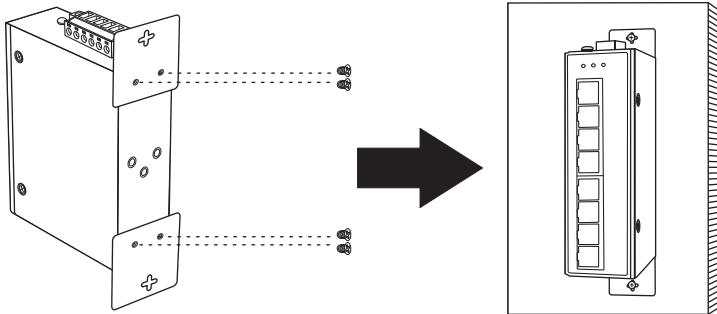

## Applying Power

1. Connect the power supply (sold separately) to the included terminal block (as shown below) and secure with the screws.

**Note:** Polarities must match.

2. Attach the terminal block to the unit, connect the ground wire to the ground, and supply power to the power adapter.

**Note:** The switch model and power supply may be different than the one shown in the example below. Terminal blocks may be 4-pin (dual power input) or 6-pin (dual power input with alarm relay output) with differences in labeling.

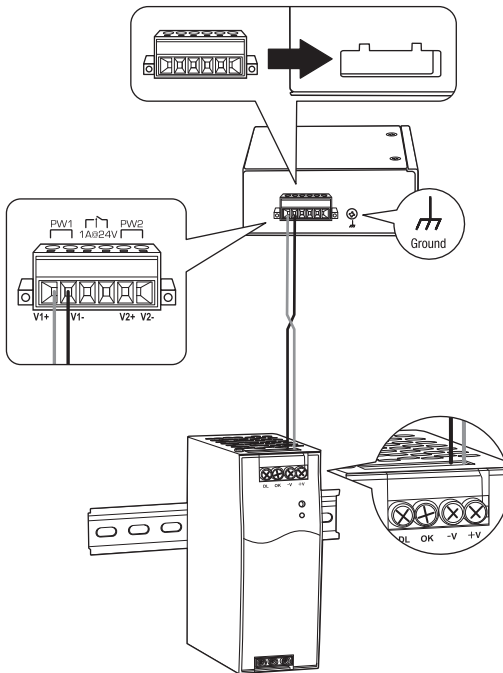



3. Connect a network source and devices to the switch. Check the LEDs to confirm the connections are established. Your installation is completed.

**Note:** Please refer to the LED definition section on page 8-9 for reference to your switch model.

If available on your switch, the 4-pin DIN type connector can also be used as an additional power input (48VDC3000 power adapter sold separately).

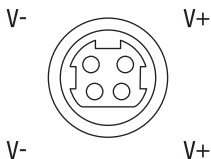

## LED Indicators

### TI-E50 / TI-G50

	Status	Description
PW1	Solid Green	Power On
	Off	Power Off or Fail
PW2	Solid Green	Power On
	Off	Power Off or Fail
LNK	Solid Green	Connected
	Blinking Green	Data Transmitting
	Off	No Connection

### TI-E80 / TI-G80

	Status	Description
PW1	Solid Green	Power is Detected
	Off	Power is Not Detected
PW2	Solid Green	Power is Detected
	Off	Power is Not Detected
RLY	Solid Amber	Connected only PW1 or PW2
	Off	Both PW1 and PW2 are connected and powered
LNK	Solid Green	Connected
	Blinking Green	Data Transmitting / Receiving
	Off	No Connection

**TI-G62**

	<b>Status</b>	<b>Description</b>
<b>PW1</b>	Solid Green	Power is Detected
	Off	Power is Not Detected
<b>PW2</b>	Solid Green	Power is Detected
	Off	Power is Not Detected
<b>RLY</b>	Solid Amber	Only PW1 or PW2 Connected
	Off	Both PW1 and PW2 are Connected and Powered
<b>LNK</b>	Solid Green	Connected
	Blinking Green	Data Transmitting / Receiving
	Off	No Connection
<b>SFP</b>	Solid Green	Connected
	Blinking Green	Data Transmitting / Receiving
	Off	No Connection

## Consignes de sécurité



- Coupez le courant avant de brancher ou retirer quelque module ou câble que ce soit. La tension électrique correcte exacte est indiquée sur l'étiquette du produit. Vérifiez le voltage de votre source d'alimentation afin de vous assurer d'utiliser la pièce adéquate. N'utilisez PAS un voltage supérieur au voltage maximum mentionné sur l'étiquette du produit.
- Calculez le courant maximum possible sur chaque câble d'alimentation et sur les câbles communs. Respectez tous les codes électriques indiquant le courant maximum accepté par chaque taille de fil. Si le courant dépasse les indications maximales, le câblage pourrait surchauffer et provoquer des dégâts importants à votre matériel.

# 1. Avant de commencer

## Contenu de l'emballage

- TI-E50 / TI-E80 / TI-G50 / TI-G80 / TI-G62
- Guide d'installation rapide
- Bornier détachable
- Fixation Rail DIN
- Plaques pour fixation murale

## Minimum Requirements

- Réseau existant
- Alimentation électrique

## Consommation Électrique

Modèle de switch	Consommation électrique	Fourchette de tension d'entrée DC
TI-E50	5.76W	12 – 56V DC
TI-E80	8W	12 – 56V DC
TI-G50	3W	12 – 56V DC
TI-G80	5W	12 – 56V DC
TI-G62	4.5W	12 – 56V DC

## Alimentation électrique

Modèle de Alimentation électrique	Puissance max. Fourni	Sortie DC	Type
TI-M6024	60W	24V / 2.5A	DIN-Rail
TI-S12024	120W	24V / 5A	DIN-Rail
TI-S12048	120W	48V / 2.5A	DIN-Rail
TI-S24048	240W	48V / 5A	DIN-Rail
TI-S48048	480W	48V / 10A	DIN-Rail

**Remarque:** Sélectionnez l'alimentation électrique appropriée en fonction du modèle de switch que vous avez acheté.

## 2. Référence rapides

**Remarque:** Le modèle du switch et l'alimentation peuvent être différents de ceux montrés dans l'exemple ci-dessous.

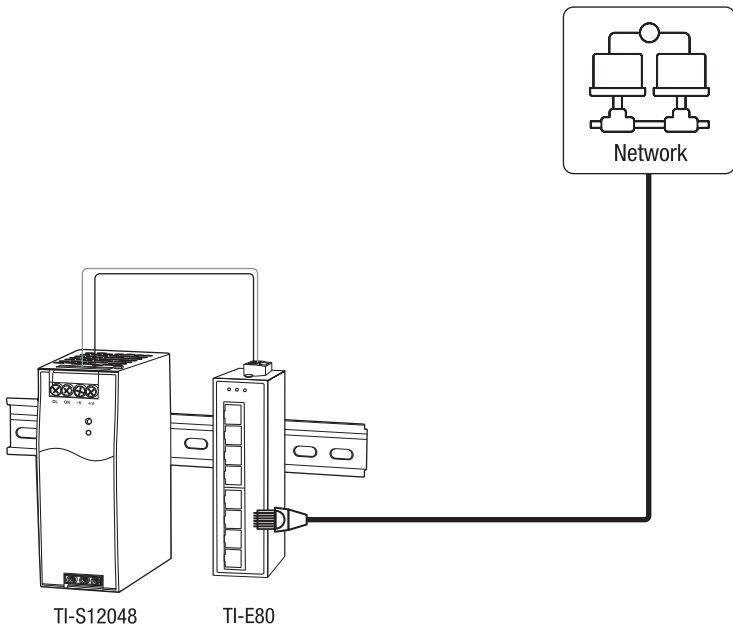

### 3. Installation du matériel

Le Switch peut être placé sur un bureau, sur un mur ou fixé sur un rail DIN.

#### **Instructions de fixation sur rail DIN**

1. Fixez le support de fixation rail DIN au switch.

**Remarque:** Le switch peut être différent de celui montré dans les exemples ci-dessous.

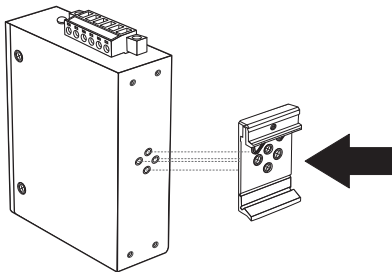

2. Installez le appareil en face du rail DIN et accrochez le support de fixation au-dessus du rail.
3. Faites pivoter l'appareil vers le bas en direction du rail afin de le fixer à son emplacement. Un clic vous avertira lorsqu'il est en place.

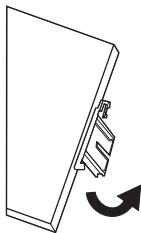

**Installation de l'appareil**

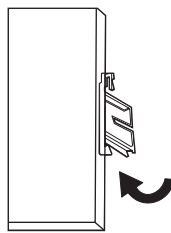

**Retirer l'appareil**

4. Pour enlever le appareil, appuyez vers le bas afin de libérer le bas du rail DIN et faites-le pivoter hors du rail.

## Instructions de fixation murale

1. Fixez les plaques de fixation murale à l' switch.
2. Installez le appareil.

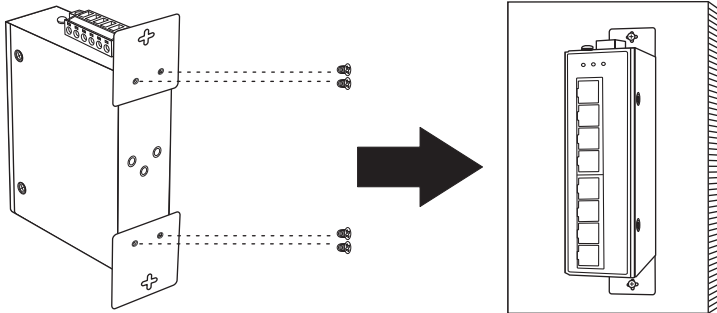



## Mise sous tension

1. Connectez l'alimentation électrique (vendu séparément) au bornier fourni (comme illustré ci-dessous) et fixez-le à l'aide de vis.

**Remarque:** Respecter les polarités.

2. Attachez la borne d'alimentation à l'appareil, connectez le câble neutre au sol et alimentez l'adaptateur secteur.

**Remarque:** Le modèle du switch et l'alimentation peuvent être différents de ceux montrés dans l'exemple ci-dessous. Les borniers peuvent comporter 4 broches (double entrée d'alimentation uniquement) ou 6 broches (double entrée d'alimentation avec sortie relais d'alarme) avec des différences d'identification.

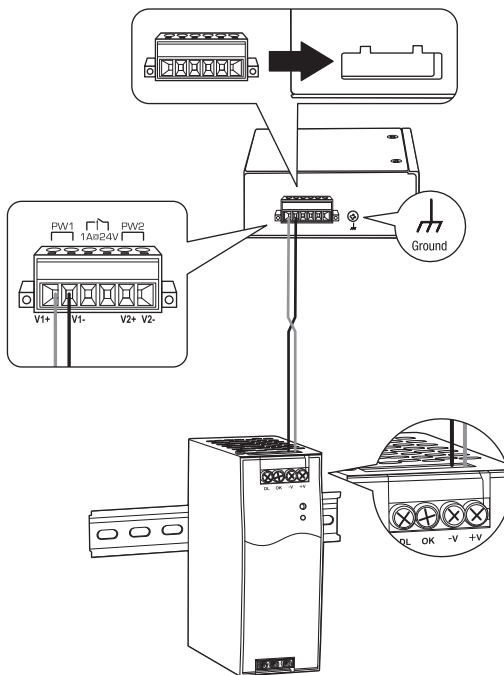

3. Connectez une source et les périphériques réseau au switch. Vérifiez les LED afin de confirmer que les connexions sont établies. Votre installation est terminée.

**Remarque:** Veuillez vous reporter à la section Définition des LED des pages 8-9 pour plus de détails sur votre modèle de switch.

Si disponible sur votre switch, la fiche DIN à 4 broches peut également être utilisée comme entrée d'alimentation supplémentaire (adaptateur 48VDC3000 vendu séparément).

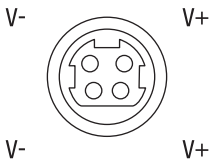

## Sicherheitshinweis



- Stellen Sie den Strom ab, bevor Sie ein oder Entfernen Modul oder Kabel anschließen. Die richtige Stromversorgungsspannung ist auf dem Etikett des Produkts angegeben. Überprüfen Sie die Spannung Ihrer Stromquelle, um sicherzustellen, dass Sie den richtigen Teil verwenden. Überschreiten Sie NICHT die auf dem Produktetikett angegebene Höchstspannung
- Berechnen Sie den maximal möglichen Strom für jedes Kabel und die gemeinsame Leitung. Beachten Sie alle Elektrorichtlinien, die den maximal zulässigen Strom für jede Kabelgröße vorschreiben. Bei Überschreitung der Maximalwerte können sich die Kabel überhitzen und Ihre Ausrüstung schwer beschädigen.

# 1. Bevor Sie Anfangen

## Paketinhalte

- TI-E50 / TI-E80 / TI-G50 / TI-G80 / TI-G62
- Kurzanleitung zur Installation
- Abnehmbare Anschlussleiste
- DIN-Schienenmontage
- Wandmontageplatten

## Mindestanforderungen

- Bestehendes Netzwerk
- Stromversorgung

## Stromverbrauch

Switch-Modell	Stromverbrauch	DC-Eingangsbereich
TI-E50	5.76W	12 – 56V DC
TI-E80	8W	12 – 56V DC
TI-G50	3W	12 – 56V DC
TI-G80	5W	12 – 56V DC
TI-G62	4.5W	12 – 56V DC

## Netzteile

Netzteil-Modell	Max. Leistung Geliefert	DC-Ausgang	Typ
TI-M6024	60W	24V / 2.5A	DIN-Rail
TI-S12024	120W	24V / 5A	DIN-Rail
TI-S12048	120W	48V / 2.5A	DIN-Rail
TI-S24048	240W	48V / 5A	DIN-Rail
TI-S48048	480W	48V / 10A	DIN-Rail

**Hinweis:** Wählen Sie das passende Netzteil zu dem von Ihnen erworbenen Switch-Modell.

## 2. Schnellübersicht

**Hinweis:** Das Switch-Modell und das Netzteil können von dem im folgenden Beispiel abweichen

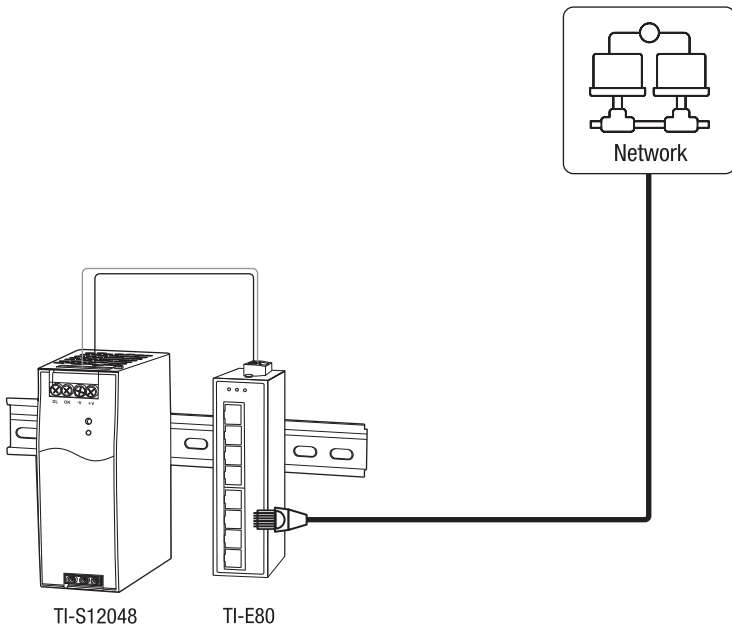

### 3. Hardware-Installation

Der Schalter kann auf dem Desktop, an der Wand oder auf einer DIN-Schiene installiert werden.

#### Anleitung zur DIN-Schienenmontage

1. Befestigen Sie die DIN-Schienenmontageklammer am Schalter.

**Hinweis:** Der Switch kann sich von dem in den folgenden Beispielen gezeigten unterscheiden.

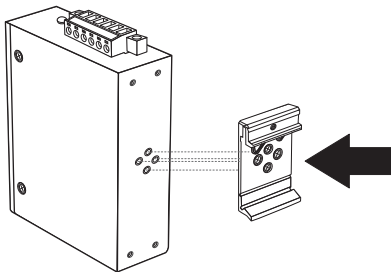

2. Positionieren Sie den gerät vor der DIN-Schiene und haken Sie die Montageklammer über dem oberen Teil der Schiene.

3. Drehen Sie den den Gerät nach unten zur Schiene hin, um ihn zu befestigen. Sie hören ein Klicken, wenn er einrastet.

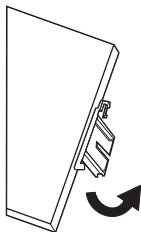

Montage des Gerät

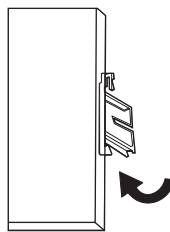

Freigabe des Gerät

4. Um den Gerät zu entfernen, nach unten ziehen, um das Ende der DIN-Schiene freizumachen, und von der Schiene wegdrehen.

## Anweisungen zur Wandmontage

1. Befestigen Sie die Wandbefestigungsplatten am Medienkonverter.
2. Montieren Sie den Gerät.

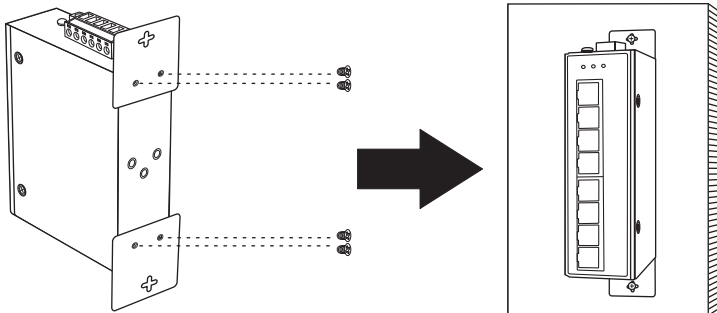

## Stromanschluss

1. Befestigen Sie den Stromversorgung (getrennt erhältlich) an dem inbegriffenen Anschlussleiste (wie unten gezeigt), und sichern Sie ihn mit den Schrauben.

**Hinweis:** Die Polaritäten müssen passen.

2. Schließen Sie den Anschlussblock an das Gerät an, bringen Sie den Nullleiter in Kontakt mit dem Boden und versorgen Sie den Netzadapter mit Strom.

**Hinweis:** Das Switch-Modell und das Netzteil können von dem im folgenden Beispiel abweichen. Die Klemmenblöcke können 4-polig (nur bei Dual Power Input) oder 6-polig (Dual Power Input mit Alarmrelaisausgang) mit unterschiedlichen Beschriftungen sein.

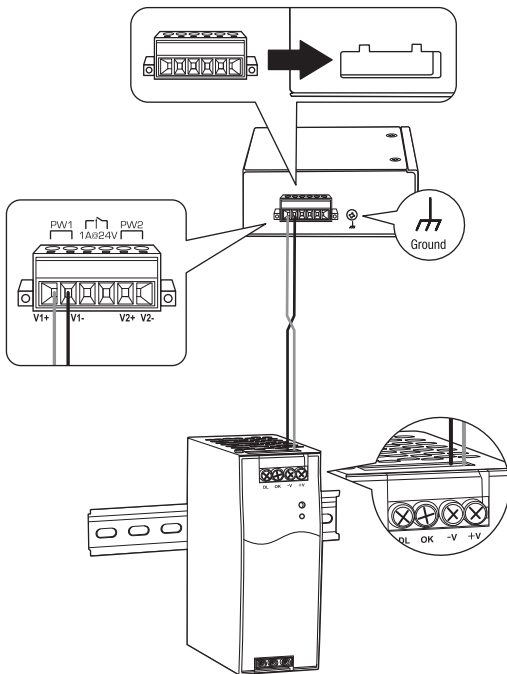



3. Schließen Sie eine Netzwerkquelle und die Geräte an den Schalter an. Überprüfen Sie die LEDs, um sicherzustellen, dass die Anschlüsse funktionieren. Ihre Installation ist abgeschlossen.

**Hinweis:**

Bitte beachten Sie den Abschnitt zur LED-Definition auf Seite 8-9 für Ihr Switch-Modell.

Wenn auf Ihrem Switch vorhanden, kann der 4-polige DIN-Stecker auch als zusätzlicher Netzeingang verwendet werden (48VDC3000-Netzteil separat erhältlich).

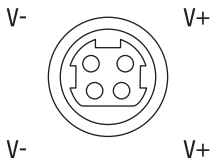

## Nota de seguridad



- Apague la alimentación antes de conectar o quitar cualquier módulo o cable. El voltaje correcto de suministro de alimentación figura en la etiqueta del producto. Compruebe el voltaje de su fuente de alimentación para asegurarse de que esté utilizando la parte correcta. **NO** utilice un voltaje superior al máximo especificado en la etiqueta del producto.
- Calcule la corriente máxima posible en cada cable de alimentación y cable común. Observe todos los códigos eléctricos que dictan la corriente máxima permisible para cada tamaño de cable. Si la corriente supera las calificaciones máximas, el cableado podría sobrecalentarse y producir daños graves en su equipo.

# 1. Antes de comenzar

## Package Contents

- TI-E50 / TI-E80 / TI-G50 / TI-G80 / TI-G62
- Guía de instalación rápida
- Bloque de terminales extraíble
- Montaje en Carril DIN
- Placas para montaje en pared

## Minimum Requirements

- Red existente
- Fuente de alimentación

## Consumo de Alimentación

Modelo de switch	Consumo de alimentación del switch	Intervalo de voltaje de entrada de CC
TI-E50	5.76W	12 – 56V DC
TI-E80	8W	12 – 56V DC
TI-G50	3W	12 – 56V DC
TI-G80	5W	12 – 56V DC
TI-G62	4.5W	12 – 56V DC

## Fuente Alimentación

Modelo de fuente alimentación	Potencia máxima du suministrado	Potencia de Salida de CC	Typo
TI-M6024	60W	24V / 2.5A	DIN-Rail
TI-S12024	120W	24V / 5A	DIN-Rail
TI-S12048	120W	48V / 2.5A	DIN-Rail
TI-S24048	240W	48V / 5A	DIN-Rail
TI-S48048	480W	48V / 10A	DIN-Rail

**Nota:** Seleccione la fuente de alimentación adecuada según el modelo de su interruptor.

## 2. Referencia rápida

**Nota:** El modelo de switch y la fuente de alimentación pueden ser diferentes a los que se muestran en el siguiente ejemplo.

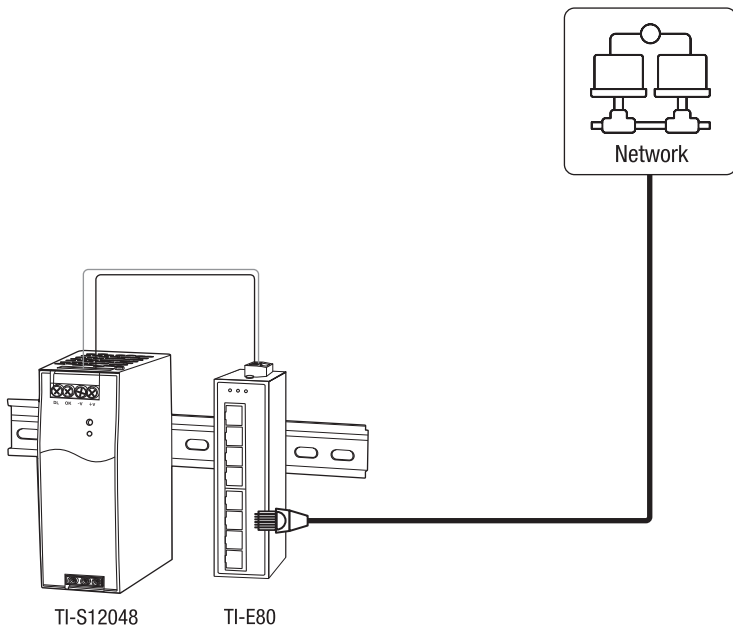

### 3. Instalación del hardware

El switch puede colocarse en un escritorio o montarse en una pared o en DIN-Rail.

#### Instrucciones de montaje en DIN-Rail

1. Acople el soporte de montaje DIN-rail al switch.

**Nota:** El switch puede ser diferente al que se muestra en los siguientes ejemplos.

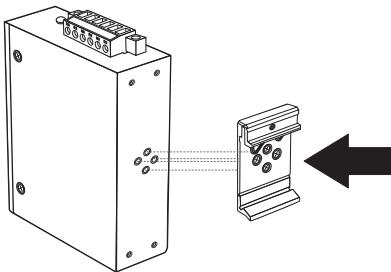

2. Coloque la unidad en frente del DIN-Rail y enganche el soporte de montaje en el carril.
3. Gire el unidad para abajo, hacia el carril, hasta dejarlo fijado. Escuchará un clic cuando quede fijado.

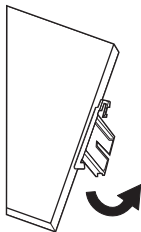

**Montando la unidad**

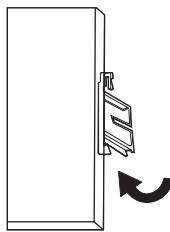

**Soltando la unidad**

4. Para retirar la unidad, presione hacia abajo para liberar la parte inferior del DIN-rail y gírelo hasta sacarlo del carril.

## Instrucciones para montaje en pared

1. Fije las placas de montaje en pared al switch.
2. Monte la unidad.

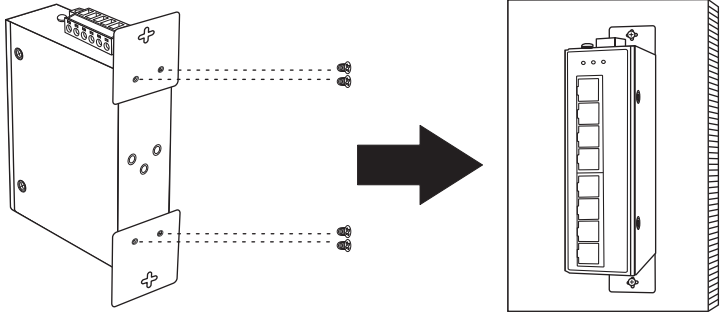

## Applicar la alimentación

1. Conecte el fuente de alimentación (se vende por separado) al bloque de terminales incluido (según se indica más abajo) y fíjelo con los tornillos.

**Nota:** Las polaridades deben coincidir.

2. Acople el bloque terminal a la unidad, conecte el cable neutro a tierra y suministre alimentación al adaptador de corriente.

**Nota:** El switch puede ser diferente al que se muestra en los siguientes ejemplos. Los bloques de terminales pueden ser de 4 pines (solo entrada de alimentación dual) o de 6 pines (entrada de alimentación dual con salida de relé de alarma), con diferencias en el etiquetado.

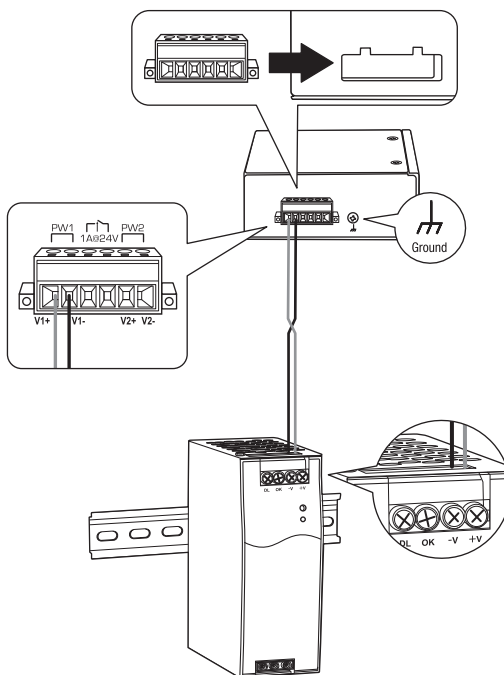

3. Conecte una fuente de red y dispositivos al switch. Compruebe los LED para confirmar que las conexiones estén establecidas. Su instalación ha finalizado.

**Nota:** Consulte la sección de definición de LED en las páginas 8-9 para obtener información sobre el modelo de su switch.

Si está disponible en su switch, el conector de 4 pines tipo DIN también se puede utilizar como una entrada de alimentación adicional (el adaptador de alimentación 48VDC3000 se vende por separado).

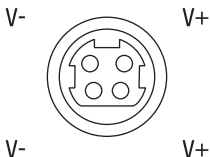



## Nota de segurança



- Desligue a energia antes de conectar ou remoção qualquer módulo ou fio. A tensão correta da fonte de alimentação está indicada na etiqueta do produto. Verifique a tensão de sua fonte de energia para certificar-se de que está usando a peça correta. **NÃO** use uma tensão maior do que conforme especificado na etiqueta do produto.
- Calculate the maximum possible current in each power wire and common wire. Observe all electrical codes dictating the maximum current allowable for each wire size. If the current surpasses the maximum ratings, the wiring could overheat, causing serious damage to your equipment.

# 1. Antes de Começar

## Package Contents

- TI-E50 / TI-E80 / TI-G50 / TI-G80 / TI-G62
- Guia de instalação rápida
- Bloco de terminais removível
- Montagem em Trilho DIN
- Placas de montagem na parede

## Minimum Requirements

- Rede existente
- Fonte de alimentação

## Consumo de Energia

Modelo do Switch	Consumo de Energia	Faixa de Tensão da Entrada DC
TI-E50	5.76W	12 – 56V DC
TI-E80	8W	12 – 56V DC
TI-G50	3W	12 – 56V DC
TI-G80	5W	12 – 56V DC
TI-G62	4.5W	12 – 56V DC

## Fonte de energia

Modelo do Fonte de energia	Fornecido do Máx. Potência	Saída DC	Tipo
TI-M6024	60W	24V / 2.5A	Trilho DIN
TI-S12024	120W	24V / 5A	Trilho DIN
TI-S12048	120W	48V / 2.5A	Trilho DIN
TI-S24048	240W	48V / 5A	Trilho DIN
TI-S48048	480W	48V / 10A	Trilho DIN

**Nota:** Seleccione la fuente de alimentación adecuada según el modelo de switch que haya adquirido.

## 2. Consulta rápida

**Nota:** O modelo do switch e a fonte de alimentação podem ser diferentes dos mostrados no exemplo abaixo.

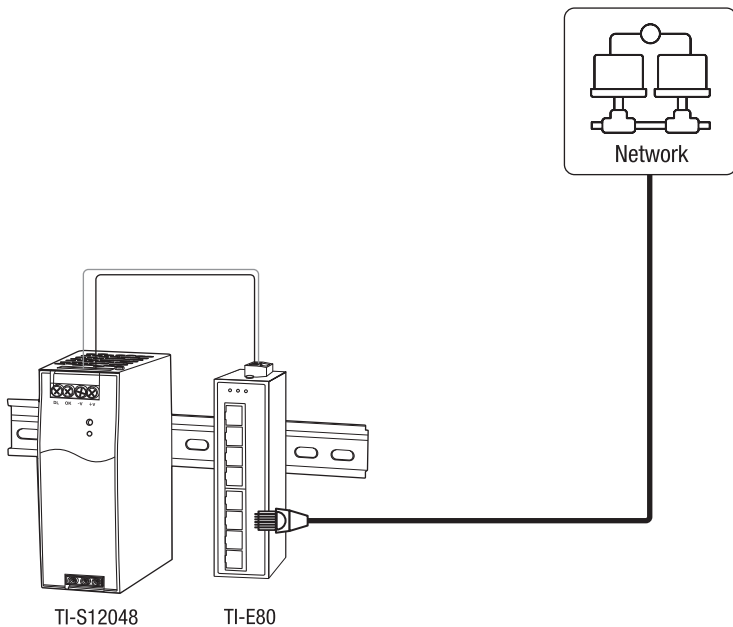

### 3. Instalação de Hardware

O switch pode ser colocado sobre uma mesa, parede ou montado em um trilho DIN.

#### DIN-Rail Mounting Instructions

1. Fixe o suporte de montagem em trilho DIN no switch.

**Nota:** O switch e fonte de alimentação pode ser diferente dos mostrados nos exemplos abaixo.

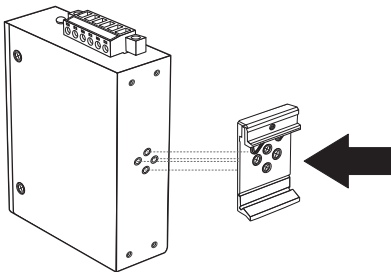

2. Posicione o unidade na frente do trilho DIN e enganche o suporte de montagem na parte superior do trilho.
3. Gire o conversor de mídia para baixo na direção do trilho para travá-lo no local adequado. Você saberá que ele está seguro quando ouvir um clique.

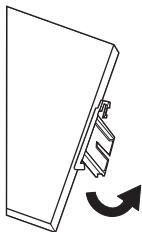

**Montagem do unidade**

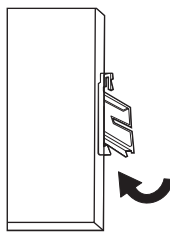

**Liberação do unidade**

4. Para remover o unidade, pressione para baixo para afastar a parte inferior do trilho DIN e gire, afastando-o do trilho.

## Instruções de montagem na parede

1. Fixe as placas de montagem na parede no switch.
2. Monte o switch.

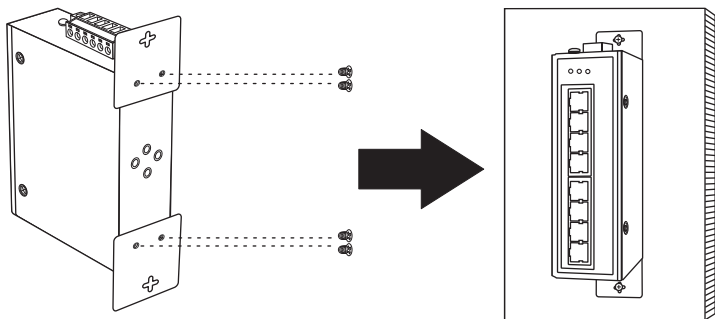

## ApplyAplicação de energia

1. Conecte o fonte de alimentação (vendido separadamente) ao bloco de terminais incluído (como exibido abaixo) e fixe com parafusos.

**Nota:** As polaridades devem coincidir.

2. Fixe o bloco de terminais na unidade, conecte o fio neutro ao aterramento e a fonte de alimentação ao adaptador de energia.

**Nota:** O switch pode ser diferente dos mostrados nos exemplos abaixo. Os blocos de terminais podem ser de 4 pinos (somente entrada de energia dupla) ou 6 pinos (entrada de energia dupla com saída de relé de alarme) com diferenças na rotulagem.

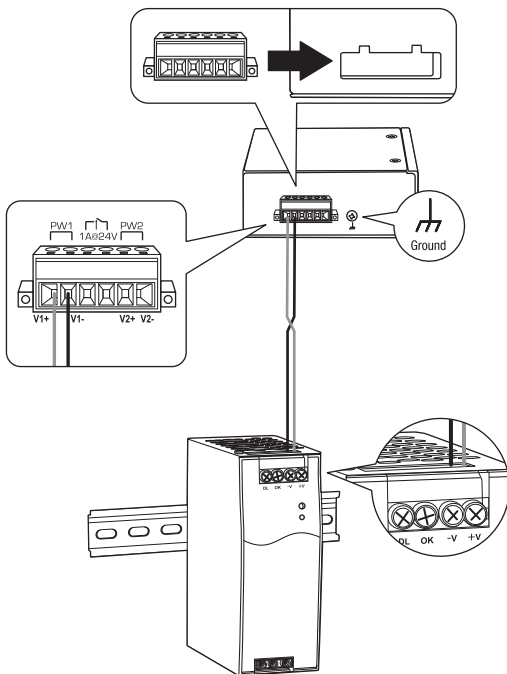

3. Conecte uma fonte de rede e dispositivos no switch. Verifique os LEDs para confirmar se as conexões estão estabelecidas. Sua instalação está concluída.

**Nota:** Consulte a seção de definição de LED na página 8-9 para referência ao seu modelo de switch.

Se disponível no seu switch, o conector tipo DIN de 4 pinos também pode ser usado como uma entrada de alimentação adicional (adaptador de alimentação 48VDC3000 vendido separadamente).

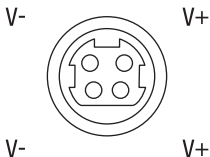

## Nota di sicurezza



- Spegnere l'alimentazione prima di collegare o rimuovere qualsiasi modulo o filo. La corretta tensione di alimentazione è elencata sull'etichetta del prodotto. Controllare il voltaggio della propria fonte di alimentazione per accertarsi di stare usando la parte corretta. Non utilizzare un voltaggio superiore, come specificato sull'etichetta del prodotto.
- Calcolare la massima corrente possibile in ciascun cavo di alimentazione e cavo comune. Osservare tutti i codici elettrici che raccomandano la corrente massima disponibile per ciascuna dimensione del filo. Se la corrente supera la tensione nominale massima, il cablaggio potrebbe surriscaldarsi, causando seri danni alla vostra apparecchiatura.



## 1. Prima di cominciare

### Package Contents

- TI-E50 / TI-E80 / TI-G50 / TI-G80 / TI-G62
- Guida di Installazione Rapida
- Blocco contatti estraibile
- Montaggio su Guida DIN
- Piastra di montaggio a parete

### Minimum Requirements

- Rete esistente
- Alimentatore

### Consumo Energetico

Modello Switch	Consumo energetico dell'interruttore	Campo Tensione di Ingresso CC
TI-E50	5.76W	12 – 56V DC
TI-E80	8W	12 – 56V DC
TI-G50	3W	12 – 56V DC
TI-G80	5W	12 – 56V DC
TI-G62	4.5W	12 – 56V DC

### Alimentazione elettrica

Alimentazione elettrica Modello	Alimenta-zione Max.	Uscite DC	Tipo
TI-M6024	60W	24V / 2.5A	Guida DIN
TI-S12024	120W	24V / 5A	Guida DIN
TI-S12048	120W	48V / 2.5A	Guida DIN
TI-S24048	240W	48V / 5A	Guida DIN
TI-S48048	480W	48V / 10A	Guida DIN

**Nota:** Selezionare l'alimentazione appropriata in base al modello di switch acquistato.

## 2. Riferimento rapido

**Nota:** Il modello di switch e l'alimentatore possono essere differenti da quelli mostrati nell'esempio seguente.

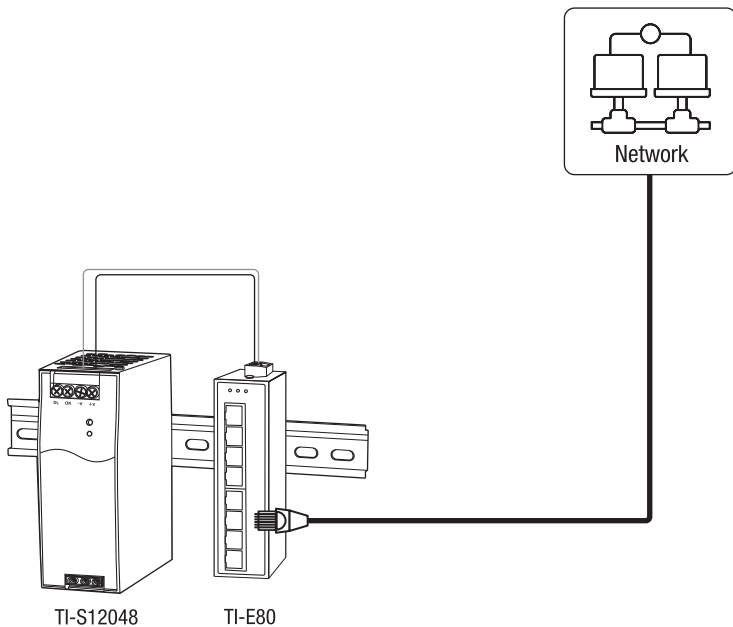

### 3. Installazione Hardware

L'interruttore può essere posizionato su tavolo, a muro oppure montato su guida DIN.

#### Istruzioni per il montaggio su guida DIN

1. Montare la staffa DIN sullo convertitore.

**Nota:** Il modello di switch e l'alimentatore possono essere differenti da quelli mostrati nell'esempio seguente.

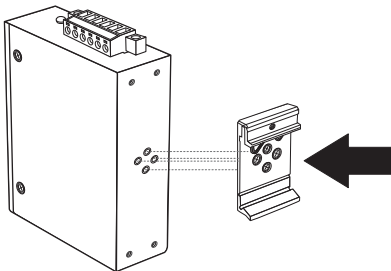

2. Posizionare l'unità di fronte al DIN-Rail e agganciare la staffa di montaggio sopra la parte superiore del binario.
3. Ruotate l'unità in basso in basso verso la guida per bloccarlo in posizione. Sarà fissato quando udirete lo scatto.

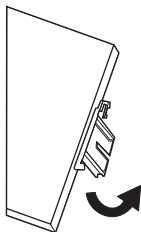

**Installazione dello unità**

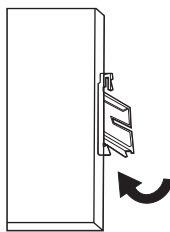

**Disinstallazione dello unità**

4. Per rimuovere l'unità, spingere per liberare la parte inferiore del DIN-Rail e ruotare per allontanare dal binario.

## Istruzione per il montaggio a muro

1. Fissare allo switch la piastra di montaggio a parete.
2. Installare lo switch.

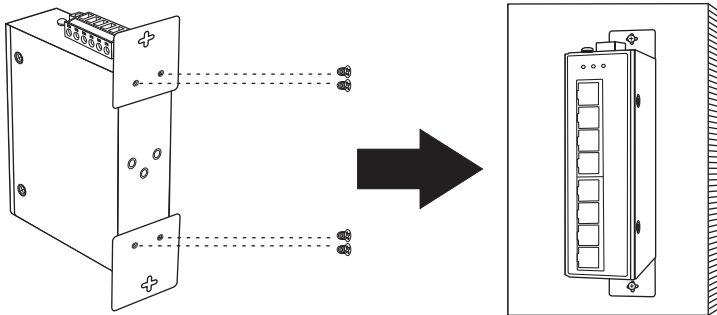

## Collegare l'alimentazione

1. Collegare l'alimentatore (venduto a parte) al blocco contatti in dotazione (come mostrato in basso) e stringere le viti.

**Nota:** Rispettare le polarità.

2. Inserire il blocco contatti sull'unità, collegare il filo di terra e fornire corrente all'alimentatore

**Nota:** Il modello di switch e l'alimentatore possono essere differenti da quelli mostrati nell'esempio seguente. I blocchi terminali del connettore possono essere a 4 pin (doppia alimentazione) o a 6 pin (a doppia alimentazione con uscita relè di allarme) differenziati per quanto riguarda l'etichettatura.

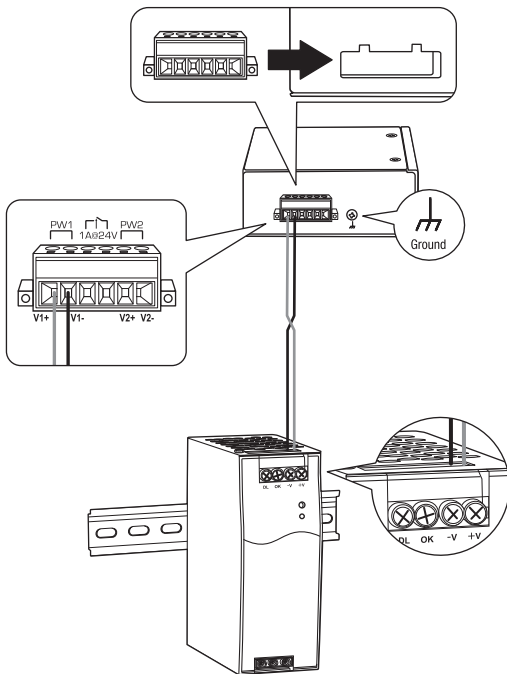

3. Collegare il cavo Ethernet, installare un modulo SFP e collegare un cavo in fibra al convertitore. Controllare i LED per verificare che le connessioni siano stabilite. La vostra installazione è completa.

**Nota:** Fare riferimento alla sezione sulla descrizione dei LED a pagina 8-9 per riferirsi al proprio modello di switch.

Se disponibile sul proprio switch, il connettore di tipo DIN a 4 pin può essere utilizzato anche come ingresso di alimentazione supplementare (alimentatore 48 VCC 3000 venduto separatamente).

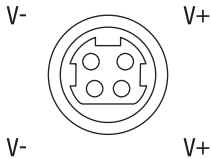

# Declaration of Conformity

TRENDnet®

## Manufacturer's Name and Address

TRENDnet, Inc. Zwolsestraat 156 2587 WB  
20675 Manhattan Place The Hague  
Torrance, CA 90501 USA The Netherlands



## Product Information:

**Model Number:** TI-E50 / TI-E80 / TI-G50 / TI-G80 / TI-G62  
**Product Name:** 5-Port Industrial Fast Ethernet DIN-Rail Switch /  
8-Port Industrial Fast Ethernet DIN-Rail Switch /  
5-Port Industrial Gigabit Ethernet DIN-Rail Switch /  
8-Port Industrial Gigabit Ethernet DIN-Rail Switch /  
7-Port Industrial Gigabit DIN-Rail Switch

**Trade Name:** TRENDnet

TRENDnet hereby declare that the product is in compliance with the essential requirements and other relevant provisions under our sole responsibility.

**Safety** EN 62368-1:2014 (Second Edition)

**EMC** EN 55032:2015  
AS/NZS CISPR 32:2015  
EN 55035:2017/A11:2020  
IEC 61000-4-2: 2008  
IEC 61000-4-3: 2020  
IEC 61000-4-4: 2012  
IEC 61000-4-5: 2014/A1:2017  
IEC 61000-4-6: 2013/COR1:2015  
IEC 61000-4-8: 2009

This product is herewith confirmed to comply with the Directives.

**Directives:** EMC Directive 2014/30/EC  
RoHS Directive 2011/65/EU  
RoHS 3 Directive 2015/863/EU  
WEEE Directive 2012/19/EU  
REACH Regulation (EC) No. 1907/2006  
Low Voltage Directive 2014/35/EU

Person responsible for this declaration.

Place of Issue: Torrance, California, USA

Date: September 31, 2024

Name: Sonny Su

Title: VP of Technology

Signature:

A handwritten signature in black ink, appearing to read 'Sonny Su', is written over a horizontal line.



# Déclaration de conformité

TRENDNET®

## Nom et adresse du fabricant

TRENDnet, Inc. Zwolsestraat 156 2587 WB  
20675 Manhattan Place The Hague  
Torrance, CA 90501 USA The Netherlands



## Détails du produit:

**Modèle:** TI-E50 / TI-E80 / TI-G50 / TI-G80 / TI-G62  
**Nom du produit:** Switch Rail DIN Fast Ethernet industriel à 5 ports /  
Switch Rail DIN Gigabit Ethernet industriel à 5 ports /  
Switch Rail DIN Fast Ethernet industriel à 8 ports /  
Switch Rail DIN Gigabit Ethernet industriel à 8 ports /  
Switch Rail DIN Gigabit industriel à 7 ports

**Nom Commercial:** TRENDnet

TRENDnet déclare par la présente que le produit est conforme aux exigences essentielles et aux autres dispositions pertinentes de la Directive en vertu de notre seule responsabilité.

**Sécurité:** EN 62368-1:2014 (Seconde édition)

**CEM** EN 55032:2015  
AS/NZS CISPR 32:2015  
EN 55035:2017/A11:2020  
IEC 61000-4-2: 2008  
IEC 61000-4-3: 2020  
IEC 61000-4-4: 2012  
IEC 61000-4-5: 2014/A1:2017  
IEC 61000-4-6: 2013/COR1:2015  
IEC 61000-4-8: 2009

Ce produit est conforme à la directives suivante.

**Directives:** Directive CEM 2014/30/UE  
Directive RoHS 2011/65/UE  
Directive 2015/863/UE (RoHS 3)  
Directive WEEE 2012/19/UE  
REACH Règlement (CE) N° 1907/2006  
Directive Basse Tension 2014/35/UE

Ce produit est conforme à la directives suivante.

Lieu de délivrance: Torrance, California, USA

Date: 31 septembre, 2024

Nom: Sonny Su

Position: Vice-président de Technologie

Signature:





# Konformitätserklärung

TRENDnet®

## Name und Adresse des Herstellers

TRENDnet, Inc. Zwolsestraat 156 2587 WB  
20675 Manhattan Place The Hague  
Torrance, CA 90501 USA The Netherlands



## Informationen zum Produkt:

**Modellnummer:** TI-E50 / TI-E80 / TI-G50 / TI-G80 / TI-G62  
**Produktname:** 5-Port industrieller Fast Ethernet DIN-Rail Switch /  
5-Port Industrieller Gigabit Ethernet DIN-Rail Switch /  
8-Port industrieller Fast Ethernet DIN-Rail Switch /  
8-Port Industrieller Gigabit Ethernet DIN-Rail Switch /  
7-Port Industrieller Gigabit DIN-DIN-Rail-Switch

**Handelsname:** TRENDnet

TRENDnet erklärt hiermit, dass das Produkt den grundlegenden Anforderungen und anderen relevanten Bestimmungen unter unserer alleinigen Verantwortung entspricht.

**Sicherheit** EN 62368-1:2014 (Zweite Ausgabe)

**EMV** EN 55032:2015  
AS/NZS CISPR 32:2015  
EN 55035:2017/A11:2020  
IEC 61000-4-2: 2008  
IEC 61000-4-3: 2020  
IEC 61000-4-4: 2012  
IEC 61000-4-5: 2014/A1:2017  
IEC 61000-4-6: 2013/COR1:2015  
IEC 61000-4-8: 2009

Hiermit wird bestätigt, dass dieses Produkt den folgenden Richtlinien entspricht.

**Richtlinien:** EMV-Richtlinie 2014/30/EU  
RoHS-Richtlinie 2011/65/EU  
RoHS-Richtlinie 2015/863/UE (RoHS 3)  
WEEE-Richtlinie 2012/19/EU  
REACH-Verordnung (EG) Nr. 1907/2006  
Niederspannungsrichtlinie 2014/35/EU

Für diese Erklärung verantwortliche Person.

Ort der Ausstellung: Torrance, California, USA

Datum: September 31, 2024

Name: Sonny Su

Titel: Vizepräsident für Technologie

Unterschrift: \_\_\_\_\_



# Declaration of Conformity

TRENDNET®

## Manufacturer's Name and Address

TRENDnet, Inc. Authorized Representative:  
20675 Manhattan Place Office: +44 (0) 1635 887 399  
Torrance, CA 90501 USA Unit 4 Rivermead Business Park,  
Pipers Way, Thatcham, RG19 4EP England



## Product Information:

**Model Number:** TI-E50 / TI-E80 / TI-G50 / TI-G80 / TI-G62  
**Product Name:** 5-Port Industrial Fast Ethernet DIN-Rail Switch /  
8-Port Industrial Fast Ethernet DIN-Rail Switch /  
5-Port Industrial Gigabit Ethernet DIN-Rail Switch /  
8-Port Industrial Gigabit Ethernet DIN-Rail Switch /  
7-Port Industrial Gigabit DIN-Rail Switch

**Trade Name:** TRENDnet

TRENDnet hereby declare that the product is in compliance with the essential requirements and other relevant provisions under our sole responsibility.

**Safety** BS EN 62368-1:2014 (Second Edition)

**EMC** BS EN 55032:2015  
BS AS/NZS CISPR 32:2015  
BS EN 55035:2017/A11:2020  
BS IEC 61000-4-2: 2008  
BS IEC 61000-4-3: 2020  
BS IEC 61000-4-4: 2012  
BS IEC 61000-4-5: 2014/A1:2017  
BS IEC 61000-4-6: 2013/COR1:2015  
BS IEC 61000-4-8: 2009

This product is herewith confirmed to comply with the Directives.

**Directives:** Electromagnetic Compatibility Regulations 2016  
The Restriction of the Use of Certain Hazardous Substances in Electrical and Electronic Equipment Regulations 2012  
The Waste Electrical and Electronic Equipment Regulations 2013 (as amended)  
The REACH Enforcement Regulations 2008 (as amended)  
Electrical Equipment (Safety) Regulations 2016

Person responsible for this declaration.

Place of Issue: Torrance, California, USA

Date: September 31, 2024

Name: Sonny Su

Title: VP of Technology

Signature: \_\_\_\_\_

A handwritten signature in black ink, appearing to read 'Sonny Su', is written over a horizontal line.



## Certifications

This device complies with Part 15 of the FCC Rules.

Operation is subject to the following two conditions:

- (1) This device may not cause harmful interference.
- (2) This device must accept any interference received.

Including interference that may cause undesired operation.



Waste electrical and electronic products must not be disposed of with household waste. Please recycle where facilities exist. Check with your Local Authority or Retailer for recycling advice.

Applies to PoE Products Only: This product is to be connected only to PoE networks without routing to the outside plant.

## Note

The Manufacturer is not responsible for any radio or TV interference caused by unauthorized modifications to this equipment. Such modifications could void the user's authority to operate the equipment.

## Advertencia

En todos nuestros equipos se mencionan claramente las características del adaptador de alimentación necesario para su funcionamiento. El uso de un adaptador distinto al mencionado puede producir daños físicos y/o daños al equipo conectado. El adaptador de alimentación debe operar con voltaje y frecuencia de la energía eléctrica domiciliar existente en el país o zona de instalación.

## Technical Support

If you have any questions regarding the product installation, please contact our Technical Support.

Toll free US/Canada: **1-855-373-4741**

Regional phone numbers available at [www.trendnet.com/support](http://www.trendnet.com/support)

## TRENDnet

20675 Manhattan Place  
Torrance, CA 90501  
USA

## Product Warranty Registration

Please take a moment to register your product online.

Go to TRENDnet's website at: [www.trendnet.com/register](http://www.trendnet.com/register)