

User's Guide

**TRENDNET**<sup>®</sup>



**AC1200 Dual Band PoE Indoor  
Wireless Access Point**

**TEW-821DAP**

## Table of Contents

<b>Product Overview .....</b>	<b>1</b>
Package Contents .....	1
Features .....	1
Product Hardware Features.....	2
Application Diagram .....	3
Getting Started .....	4
Steps to improve wireless connectivity .....	5
Connect wireless devices to your access point.....	5
<b>Configuration .....</b>	<b>6</b>
<b>Wireless Networking and Security .....</b>	<b>8</b>
How to choose the type of security for your wireless network .....	8
Secure your wireless network .....	9
Connect wireless devices using WPS .....	11
<b>Advanced configuration .....</b>	<b>12</b>
Access the management page .....	12
Operating Modes .....	13
<b>Access Point.....</b>	<b>14</b>
Basic.....	14
Wireless Profile.....	15
Wireless MAC filter .....	16
Band Steering.....	16
Airtime Fairness.....	17
Roaming Support (802.11k).....	17
RSSI Scanner .....	18
IPv6 Settings .....	18
Static IPv6 .....	19

Auto Configuration (SLAAC/DHCPv6) .....	19
Change your IP address .....	19
Captive Portal .....	20
Captive Portal with RADIUS (CoovaChilli) .....	20
Internal Captive Portal.....	21
Redirect URL .....	24
Create schedules .....	25
Configure Spanning Tree .....	25
Set date and time .....	26
Daylight Saving Time .....	26
NTP .....	26
Manual.....	26
Manage VLAN .....	27
Traffic Shaping .....	<b>Error! Bookmark not defined.</b>
Enable SNMP .....	28
Enable CLI .....	<b>Error! Bookmark not defined.</b>
LED Controls .....	29
<b>Client Bridge .....</b>	<b>29</b>
Basic.....	29
Scan for wireless networks.....	30
<b>WDS .....</b>	<b>32</b>
WDS Link.....	32
Basic.....	<b>Error! Bookmark not defined.</b>
Wireless Profile.....	<b>Error! Bookmark not defined.</b>
<b>Repeater.....</b>	<b>33</b>
Basic.....	33
Scan for wireless networks.....	34
Advanced wireless settings .....	35

Advanced Wireless.....	35	<b>Appendix .....</b>	<b>51</b>
HT Physical Mode .....	35		
Client Limit .....	35		
<b>Maintenance &amp; Monitoring .....</b>	<b>36</b>		
Administration .....	36		
Device Name .....	36		
Reset to factory defaults .....	36		
Backup and restore your configuration settings .....	37		
Restart access point .....	37		
Upgrade your firmware .....	38		
Configure log.....	38		
Test connectivity.....	38		
Check system information .....	39		
Check connected wireless clients .....	40		
System Log .....	40		
IPv6 Status .....	40		
<b>AP utility.....</b>	<b>41</b>		
Installation .....	41		
Device Settings .....	41		
Add and Delete Device .....	42		
Upgrade Firmware.....	42		
Load configuration.....	43		
Access Points .....	44		
Clients .....	44		
Statistics.....	45		
<b>Technical Specifications.....</b>	<b>47</b>		
<b>Troubleshooting.....</b>	<b>50</b>		

## Product Overview



**TEW-821DAP**

## Package Contents

In addition to your access point, the package includes:

- TEW-821DAP
- 5 ft. (1.5 m) network cable
- Quick Installation Guide
- Power adapter (12V DC, 1A)
- Mounting plate and cable guard

If any package contents are missing or damaged, please contact the retail store, online retailer, or reseller/distributor from which the product was purchased.

## Features

TRENDnet's high performance AC1200 Dual Band Indoor Wireless PoE Access Point, model TEW-821DAP, supports Access Point (AP), Client Bridge, Wireless Distribution System Access Point (WDS AP), WDS Bridge, WDS Station, and Repeater modes. This wireless indoor access point generates concurrent 867Mbps WiFi AC and 300Mbps WiFi N networks. MU-MIMO technology processes multiple data streams simultaneously, increasing real-time WiFi performance when multiple devices access the network. It features advanced access control, QoS, traffic management, band steering, and captive portal support. The low-profile housing design blends into most environments and includes a convenient wall / ceiling mounting plate with cable guard.

### Concurrent Dual Band

AC1200: concurrent 867 Mbps WiFi AC + 300 Mbps WiFi N bands

### Power over Ethernet (PoE)

Saves installation time and costs with gigabit PoE support (optional power port for non-PoE installations)

### Access Point Modes

Supports Access Point (AP), Client, WDS AP, WDS Bridge, WDS Station, and Repeater modes for each WiFi band independently

### Gigabit Port

Gigabit PoE LAN port maintains high performance connections to the wired network

### Wireless Coverage

Extended wireless coverage with MU-MIMO antenna technology

### MU-MIMO Performance

MU-MIMO technology enables the access point to process multiple data streams simultaneously, and increases real-time WiFi performance

### Encrypted Wireless

Support for wireless encryption of up to WPA2

## Band Steering

Band steering alleviates network congestion by automatically directing wireless devices from the 2.4 GHz band to the 5 GHz band

## WiFi Traffic Shaping

Manage traffic allocation per VLAN for each band separately

## Multiple SSIDs

Create up to 8 SSIDs per band (16 total)

## Low Profile

Low-profile shape housing design blends into most environments

## LED Control

Reduce product visibility by turning off LED indicators

## Mounting Plate

Wall / Ceiling mounting plate with cable guard

\*Maximum wireless signal rates are referenced from IEEE 802.11 theoretical specifications. Actual data throughput and coverage will vary depending on interference, network traffic, building materials and other conditions.

## Product Hardware Features

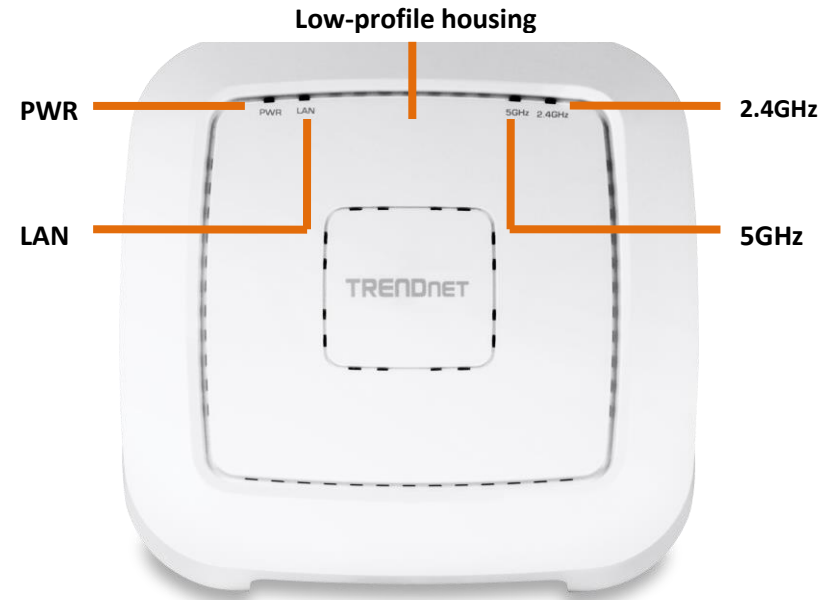

- **PWR:** This indicator turns green when the device is powered.
- **LAN:** This LED indicator turns green when the access point LAN port is connected. The LED indicator blinks during data transmission
- **5GHz:** This LED indicator turns green when the wireless is enabled. The LED indicator blinks during data transmission
- **2.4GHz:** This LED indicator turns green when the wireless is enabled. The LED indicator blinks during data transmission

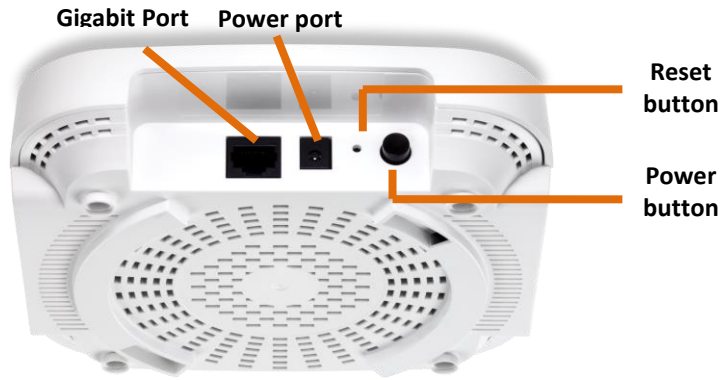

- **Gigabit PoE port:** Plug an Ethernet cable (also called network cables) from your access point to your router and wired network devices. The Gigabit port complies with standard 802.3af/at PoE/PoE+ so you can connect to connect the AP to a PoE switch or injector that complies with 802.3af/at.
- **Power port (optional):** If you are not using PoE to power the AP, you can connect the power adapter from your access point power port to an available power outlet.
- **Reset button:** Use a sharp tool to press and hold this button for 15 seconds to reset the access point.
- **Power button:** If your access point is to be powered using the power adapter, this toggle button can be used to turn on or off the access point. **Note: this only affects the Power Port connection, this button has no function if your access point is powered by a PoE connection.**

**Access Point Flexibility**

Concurrent 867Mbps WiFi AC and 300Mbps WiFi N combined with AP, Client, WDS, and Repeater modes support multiple applications.

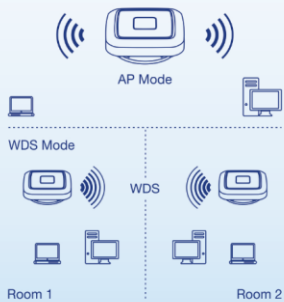

**Built For Busy Homes**

MU-MIMO technology processes multiple data streams simultaneously, increasing real-time WiFi performance when multiple devices access the network.



**Band Steering**

Band steering alleviates network congestion by automatically directing wireless devices from the 2.4GHz band to the 5GHz band.



**Application Diagram**

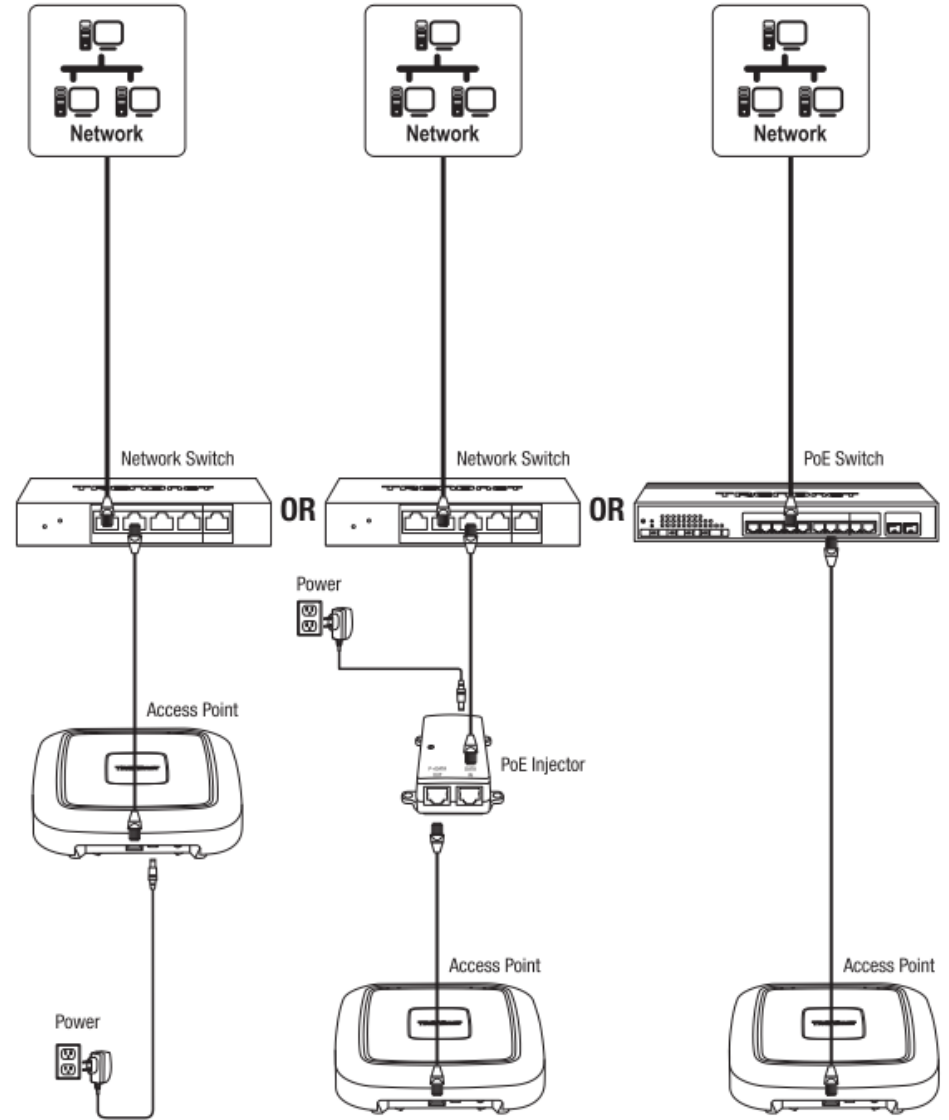

**Getting Started**

For a typical wireless setup at home or office when using the access point in AP mode, please do the following:

**Installation**

1. Connect the power adapter to the power port of the access point. Or simply plug an Ethernet cable on the access point to a PoE (Power over Ethernet) switch that connects to your router or network.
2. If using the power adapter, plug an Ethernet cable to the access point and plug the other end to your router or network.
3. Verify that all LEDs are on.
4. For your security, each TEW-821DAP comes pre-encrypted with a unique WiFi Name (SSID) and WiFi Password. You can find your device's SSID and WiFi password on the white labels located on the device. Use this information to connect to the TEW-821DAP access point.



5. Verify your connection to you network by accessing the Internet. For advanced configuration continue to the advanced sections of the user manual.

**Mounting device**

To mount the access point, first route the network cable through the largest opening in the mounting plate and install the mounting plate to the desired wall or ceiling using the included drywall anchors and screws. Install the mounting plate with the correct orientation. After the mounting plate is properly installed, connect the network cable to the network LAN port of the access point, align the access point mounting holes with the mounting plate clips and rotate the access point clockwise to lock into place. Finally, install the cable guard by sliding it onto the mounting plate until it locks into place.

**Ceiling mounting**

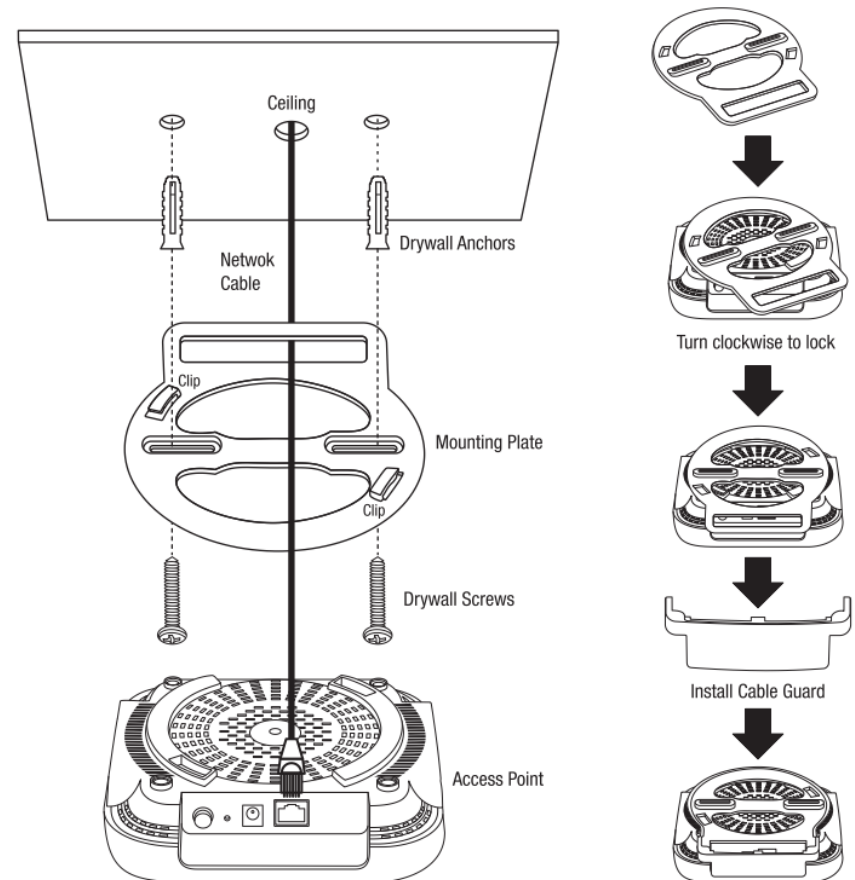

## **Steps to improve wireless connectivity**

There are a number of factors that can impact the range of wireless devices. Follow these tips to help improve your wireless connectivity:

1. Keep the number of obstructions to a minimum. Each obstruction can reduce the range of a wireless device. Position the wireless devices in a manner that will minimize the amount of obstructions between them.
  - a. For the widest coverage area, install your router near the center of your home, and near the ceiling, if possible.
  - b. Avoid placing the access point on or near metal objects (such as file cabinets and metal furniture), reflective surfaces (such as glass or mirrors), and masonry walls.
  - c. Any obstruction can weaken the wireless signal (even non-metallic objects), so the fewer obstructions between the router and the wireless device, the better.
  - d. Place the access point in a location away from other electronics, motors, and fluorescent lighting.
  - e. Many environmental variables can affect the router's performance, so if your wireless signal is weak, place the access point in several locations and test the signal strength to determine the ideal position.
2. Building materials can have a large impact on your wireless signal. In an indoor environment, try to position the wireless devices so that the signal passes through less dense material such as dry wall. Dense materials like metal, solid wood, glass or even furniture may block or degrade the signal.
3. Antenna orientation can also have a large impact on your wireless signal. Use the wireless adapter's site survey tool to determine the best antenna orientation for your wireless devices.
4. Interference from devices that produce RF (radio frequency) noise can also impact your signal. Position your wireless devices away from anything that generates RF noise, such as microwaves, radios and baby monitors.

If possible, upgrade wireless network interfaces (such as wireless cards in computers) from older wireless standards to 802.11n. If a wirelessly networked device uses an older standard, the performance of the entire wireless network may be slower. If you are still experiencing low or no signal, consider repositioning the wireless devices or installing additional access points.

## **Connect wireless devices to your access point**

A variety of wireless network devices can connect to your wireless network such as:

- Gaming Consoles
- Internet enabled TVs
- Network media players
- Smart Phones
- Wireless Laptop computers
- Wireless IP cameras

Each device may have its own software utility for searching and connecting to available wireless networks, therefore, you must refer to the User's Manual/Guide of your wireless client device to determine how to search and connect to this router's wireless network.

See the "[Appendix](#)" on page 63 for general information on connecting to a wireless network.



## Configuration

**Note:** The access point's default management page <http://192.168.10.100> is accessed through the use of your Internet web browser (e.g. Internet Explorer, Firefox, Chrome, Safari, and Opera) and will be referenced frequently in this User's Guide.

Before accessing the web-based management page, configure the IP address and subnet mask of your computer to the following:

IP Address: 192.168.10.xxx

Subnet Mask: 255.255.255.0

1. Open your web browser (e.g. Internet Explorer, Firefox, Safari, Chrome, or Opera) and go to <http://tew-821dap> or type in <http://192.168.10.100>.

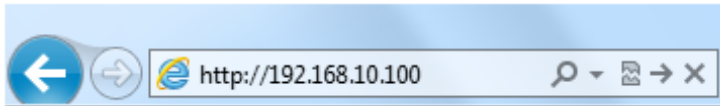

2. Enter the default user name and password and then click **Login**. You can find your device's SSID and WiFi password on the white labels located on the device. Use this information to connect to the TEW-821DAP access point.

**Preset Wireless Settings**

**Wi-Fi Name/SSID**  
(AC/N)  
TRENDnet821\_5GHz\_XXXX  
(N/B/G)  
TRENDnet821\_2.4GHz\_XXXX

**Wi-Fi Password**  
XXXXXXXXXXXXXX

**Management Login**  
<http://tew-821dap>  
username: admin  
password: XXXXXX

**TEW-821DAP LOGIN**

User Name :

Password :

Language :

## Wizard

1. For the first-time logging into the device the setup wizard will start automatically.
2. For your security, the first step is to change the login password of the access point. Enter your new login password and click OK.

**Administrator Settings**

Account

New Password  (Max: 16 characters)

Verify Password

3. Your new password settings will be applied and you will be redirected to the login screen. You will need to use the new login password to proceed.



## Using the utility

For additional information on the utility please go to utility section.

1. Download the latest version of the utility by navigating to <http://www.trendnet.com/support> and selecting model TEW-821DAP within the Product Download drop-down list.
2. Extract the contents of the .zip file and run the .exe installer to install the utility.
3. Once the utility is installed click on Discover to refresh the list of access points.

TRENDnet AP Utility

All Devices

Device Settings	Select	Product Name	IP Address	MAC Address	Version	System Name (Location)	2.4G Enable	
FW Upgrade	<input type="checkbox"/>	TEW-825DAP	<a href="http://192.168.10.20">192.168.10.20</a>	00-18-E7-95-82-1D	1.00b04	TEW-825DAP	Yes	TR
Config Upgrade	<input type="checkbox"/>	TEW-821DAP	<a href="http://192.168.10.22">192.168.10.22</a>	00-18-E7-95-92-45	1.04b08	TEW-821DAP	Yes	TR
Access Points								
Clients								
Statistics								

4. Select the access point you want to configure.

<input type="checkbox"/> Select	Product Name	IP Address	MAC Address	Version	System Name (Location)	2.4G Enable
<input type="checkbox"/>	TEW-825DAP	<a href="#">192.168.10.20</a>	00-18-E7-95-82-1D	1.00b04	TEW-825DAP	Yes
<input checked="" type="checkbox"/>	TEW-821DAP	<a href="#">192.168.10.22</a>	00-18-E7-95-92-45	1.04b08	TEW-821DAP	Yes

5. Click on Device settings to configure the access point.

- **Product Name:** Displays the device model
- **IP Mode:** Select the IP mode to apply on the device
  - **DHCP:** Select this option to allow the device to receive IP address from your DHCP server
  - **Static:** Select this option to manually set the IP address of the device
- **IP Address:** Enter the IP address to assign to the device
- **Subnet Mask:** Enter the subnet mask to assign to the device
- **Gateway:** Enter the gateway IP address to assign to the device
- **System Name:** Assign name of the device to help distinguish between similar devices
- **VLAN ID:** Assigns the VLAN ID for the Ethernet port.
- **Band Steer:** Select this to enable/disable band steering (Only available on dual band AP models)
- **Band:** Select on the pull-down menu the wireless interface to configure (5GHz only available on dual band AP models)

- **802.11 Mode:** Select the 802.11 mode of the selected wireless interface
- **Channel:** Select the wireless channel of the selected wireless interface
- **VLAN ID:** Assigns the VLAN ID for the primary SSID.
- **Separate Stations:** Select this option to restrict wireless client devices from accessing other client devices connected to this network(s).
- **Enable:** Select this option to enable the selected wireless interface
- **Visible:** Select this option to wireless broadcast the selected wireless interface
- **SSID:** Enter the SSID (Wireless Network Name) of the selected wireless interface
- **Security:** Select the wireless encryption security for to assign the selected wireless interface
- **Key:** Enter the wireless encryption security key or password
- **Password:** Enter the login password of the device and click OK to save settings

## Wireless Networking and Security

### How to choose the type of security for your wireless network

Setting up wireless security is very important. Leaving your wireless network open and unsecured could expose your entire network and personal files to outsiders. TRENDnet recommends reading through this entire section and setting up wireless security on your new access point.

There are a few different wireless security types supported in wireless networking each having its own characteristics which may be more suitable for your wireless network taking into consideration compatibility, performance, as well as the security strength along with using older wireless networking hardware (also called legacy hardware). It is strongly recommended to enable wireless security to prevent unwanted users from accessing your network and network resources (personal documents, media, etc.). In general, it is recommended that you choose the security type with the highest strength and performance supported by the wireless computers and devices in your network. Please review the security types to determine which one you should use for your network.

#### Wireless Encryption Types

- **WEP:** Legacy encryption method supported by older 802.11b/g hardware. This is the oldest and least secure type of wireless encryption. It is generally not recommended to use this encryption standard, however if you have old 802.11 b or 802.11g wireless adapters or computers with old embedded wireless cards (wireless clients), you may have to set your router to WEP to allow the old adapters to connect to the router.

**Note:** This encryption standard will limit connection speeds to 54Mbps.

- **WPA:** This encryption is significantly more robust than the WEP technology. Much of the older 802.11g hardware was upgraded (with firmware/driver upgrades) to support this encryption standard. Total wireless speeds under this encryption type however are limited to 54Mbps.
- **WPA-Auto:** This setting provides the router with the ability to detect wireless devices using either WPA or WPA2 encryption. Your wireless network will automatically change the encryption setting based on the first wireless device connected. For example, if the first wireless client that connects to your wireless network uses WPA encryption your wireless network will use WPA encryption. Only when all wireless clients disconnect to the network and a wireless client with WPA2 encryption connects your wireless network will then change to WPA2 encryption.

**Note:** WPA2 encryption supports 802.11n speeds and WPA encryption will limit your connection speeds to 54Mbps

- **WPA2:** This is the most secure wireless encryption available today, similar to WPA encryption but more robust. This encryption standard also supports the highest connection speeds. TRENDnet recommends setting your router to this encryption standard. If you find that one of your wireless network devices does not support WPA2 encryption, then set your router to either WPA or WPA-Auto encryption.

**Note:** Check the specifications of your wireless network adapters and wireless appliances to verify the highest level of encryption supported. Below is brief comparison chart of the wireless security types and the recommended configuration depending on which type you choose for your wireless network.

Security Standard	WEP	WPA	WPA2
<b>Compatible Wireless Standards</b>	IEEE 802.11a/b/g (802.11n devices will operate at 802.11g to connect using this standard)	IEEE 802.11a/b/g (802.11n devices will operate at 802.11g to connect using this standard)	IEEE 802.11a/b/g/n
<b>Highest Performance Under This Setting</b>	Up to 54Mbps	Up to 54Mbps	Up to 450Mbps (11n) and up to 1.3Gbps (11ac)*
<b>Encryption Strength</b>	Low	Medium	High
<b>Additional Options</b>	Open System or Shared Key, HEX or ASCII, Different key sizes	TKIP or AES, Preshared Key or RADIUS	TKIP or AES, Preshared Key or RADIUS
<b>Recommended Configuration</b>	Open System ASCII 13 characters	TKIP Preshared Key 8-63 characters	AES Preshared Key 8-63 characters

\*Dependent on the maximum 802.11n/ac data rate supported by the device (150Mbps, 300Mbps, 450Mbps, 867Mbps, or 1.3Gbps)

## Secure your wireless network

Wireless (2.4GHz or 5GHz) > Security

After you have determined which security type to use for your wireless network (see [“How to choose the security type for your wireless network”](#) on page 12), you can set up wireless security.

1. Log into your management page (see [“Access the management page”](#) on page 13).
2. Click on the Wireless 2.4GHz or 5GHz.



3. Underneath the basic wireless band section, you will see **Wireless Network** and all your wireless network profiles will be listed.
4. Click on the Edit button next to the wireless profile you want to configure.

Current Profiles			
Enable	SSID	Security Mode	Edit
<input checked="" type="checkbox"/>	TRENDnet821_2.4GHz_0045	WPA2-PSK AES	<a href="#">Edit</a>

5. Select from the drop-down list to the wireless security to configure.

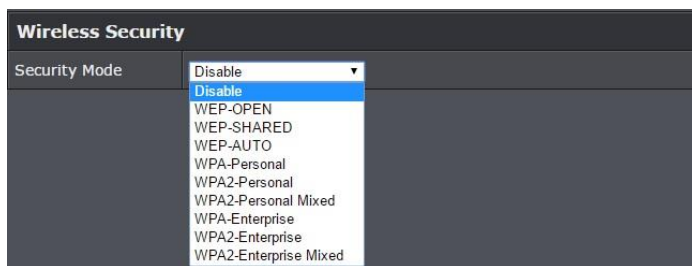

6. Review the wireless security settings, click Save then Apply/Discard on the top-left when finished.



**Selecting WEP-OPEN, WEP-SHARED:** If selecting **WEP** (Wired Equivalent Privacy), please review the WEP settings to configure and click **Save** to save the changes.

**Note:** WPS functionality is not available when using WEP.

In the **Security Mode** drop-down list, select **WEP-OPEN** or **WEP-SHARED**.

**Note:** It is recommended to use WEP-OPEN because it is known to be more secure than Shared Key.

WEP			
Default Key			Key 1 ▾
WEP Key 1 :	<input type="text"/>	<input type="checkbox"/> Show Password	HEX ▾
WEP Key 2 :	<input type="text"/>	<input type="checkbox"/> Show Password	HEX ▾
WEP Key 3 :	<input type="text"/>	<input type="checkbox"/> Show Password	HEX ▾
WEP Key 4 :	<input type="text"/>	<input type="checkbox"/> Show Password	HEX ▾

WEP Key Format	HEX	ASCII
Character set	0-9 & A-F, a-f only	Alphanumeric (a,b,C,?,*,/,1,2, etc.)
64-bit key length	10 characters	5 characters
128-bit key length	26 characters	13 characters

- **Default Key:** Select the WEP Key from the drop-down list to use
- **Network Key 1-4**
  - This is where you enter the WEP key needed for a computer to connect to the router wirelessly
  - You can define up to 4 passwords or 4 keys. Only one key can be active at a given time. Most users simply define one key.

- Choose a key index 1, 2, 3, or 4 and enter the key.
- When connecting to the access point, the client must match both the password and the Key number. (e.g. if you have activated Key 2 with a password of 12345, then the client must select: Key 2 (entering Key 1, 3, or 4 will block the ability to connect) and enter password 12345)

**Note:** It is recommended to use 128-bit format because it is more secure to use a key that consists of more characters.

- **HEX or ASCII:** Select which WEP code type to assign

**Selecting WPA- Personal, WPA2- Personal, WPA2- Personal, or Mixed (WPA2-PSK recommended):** In the **Security Mode** drop-down list, select **WPA- Personal**

WPA	
WPA Cipher	AES ▼
Pre-Shared Key	..... <input type="checkbox"/> Show Password
Key Update Interval	3600 seconds

The following section outlines options when selecting **WPA-Personal, WPA2- Personal, or WPA2- Personal Mixed** (Pre-shared Key Protocol),

- **WPA Cipher:** Select a Cipher Type to use. When selecting **WPA-PSK** security, it is recommended to use **TKIP + AES**.
  - When selecting **WPA2- Personal Mixed** security, it is recommended to use **TKIP+AES**.
  - When selecting **WPA2- Personal** security, it is recommended to use **AES**.
- **Pre-Shared Key:** Enter the passphrase or password
  - This is the password or key that is used to connect your computer to this router wirelessly

**Note:** 8-63 alphanumeric characters (a,b,c,?,\*,/,1,2, etc.)
- **Key Update Interval:** Enter the time interval (seconds) of when the network passphrase will rotate.
 

**Note:** It is recommended to use the default interval time. Your passphrase will not change; rotation of the key is part of the WPA protocol and designed to increase security.

**Selecting WPA-Enterprise, WPA2-Enterprise, or WPA2-Enterprise Mixed:**

WPA	
WPA Cipher	AES ▼
Key Update Interval	3600 seconds
Radius Server	
IP Address :	0.0.0.0
Port :	1812
Shared Secret :	<input type="text"/> <input type="checkbox"/> Show Password

The following section outlines options when selecting **WPA-Enterprise, WPA2-Enterprise or WPA2-Enterprise Mixed** known as EAP (Extensible Authentication Protocol). Also known as called Remote Authentication Dial-In User Service or **RADIUS**.

- Note:** This security type requires an external RADIUS server, PSK only requires you to create a passphrase.
- **WPA Cipher:** Select a Cipher Type to use. When selecting **WPA-PSK** security, it is recommended to use **TKIP + AES**.
- **Key Update Interval:** Enter the time interval (seconds) of when the network passphrase will rotate.
 

**Note:** It is recommended to use the default interval time. Your passphrase will not change; rotation of the key is part of the WPA protocol and designed to increase security.
- **IP Address:** Enter the IP address of the RADIUS server. (e.g. 192.168.10.250)
- **Port:** Enter the port your RADIUS server is configured to use for RADIUS authentication.
 

**Note:** It is recommended to use port 1812 which is typical default RADIUS port.
- **Shared Secret:** Enter the shared secret used to authorize your router with your RADIUS server.

## Connect wireless devices using WPS

WPS (Wi-Fi Protected Setup) is a feature that makes it easy to connect devices to your wireless network. If your wireless devices support WPS, you can use this feature to easily add wireless devices to your network.

**Note:** You will not be able to use WPS if you set the SSID Broadcast setting to Disabled or if you are using WEP security.

There are two methods the WPS feature can easily connect your wireless devices to your network.

- Push Button Configuration (PBC) method
  - WPS Software/Virtual Push Button - located in the management page
- PIN (Personal Identification Number) Method - located in the management page

**Note:** Refer to your wireless device documentation for details on the operation of WPS.

For connecting additional WPS supported devices, repeat this process for each additional device.

### PBC (Software/Virtual Push Button)

Wireless (2.4GHz or 5GHz) > WPS

In addition to the hardware push button located physically on your router, the router management page also has push button which is a software or virtual push button you can click to activate WPS on your router.

1. Log into your management page (see "[Access the management page](#)" on page 13).
2. Click on the Wireless network you want to configure button (Wireless 2.4GHz or 5GHz) and click **WPS**.

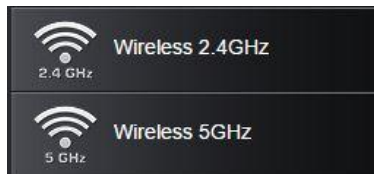

3. Click on **WPS** to configure the selected wireless band's WPS feature. Click **Save** to save settings



4. Review the WPS settings, click **Apply/Discard** when finished.

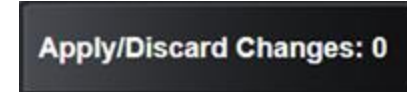

### WPS Config

WPS Config	
WPS	<input checked="" type="radio"/> Enable <input type="radio"/> Disable
WPS External Registrar Lock	<input type="radio"/> Enable <input checked="" type="radio"/> Disable

- **WPS:** Select enable to turn on WPS feature
- **WPS External Registrar Lock:** Select to enable or disable external registrar feature on the select wireless band.

### WPS Summary

WPS Summary	
WPS Current Status	Idle
WPS Configured	Yes
WPS SSID	_0001
WPS Security Mode	WPA2-PSK AES
WPS Key	1234567890
AP PIN	12345678

- **WPS Current Status:** Displays the status of WPS feature on the selected wireless band
- **WPS Configure:** Displays the configured mode of the WPS feature
- **WPS SSID:** Displays the SSID of the WPS network
- **WPS Security Mode:** Display the security mode of the WPS network

- **WPS Key:** Displays the security password
- **AP PIN:** Display the WPS PIN information.

#### WPS Action

WPS Action	
If you are using the Virtual Push Button method, click Start Push Button, then push and activate WPS on your wireless client device. If you are using the PIN method, enter the wireless client device PIN in the field and click Start PIN, then activate the WPS PIN method on your wireless client device.	
PIN	<input type="text"/> <input type="button" value="Start PIN"/>
PBC	<input type="button" value="Start Push Button"/>

- **PIN:** Enter the PIN information of the wireless client you want to connect to the network. Click Start PIN button to activate WPS once you enter the client's PIN information  
**Note:** You may need to initiate the WPS PIN on your wireless device first when using this method. Refer to your wireless device documentation for details on the operation of WPS.
- **PBC:** Click **Start Push Button** to activate WPS PBC configuration.

## Advanced configuration

### Access the management page

**Note:** Your router management page URL/domain name <http://tew-821dap> or IP address <http://192.168.10.100> is accessed through the use of your Internet web browser (e.g. Internet Explorer, Firefox, Chrome, Safari, Opera) and will be referenced frequently in this User's Guide.

1. Open your web browser (e.g. Internet Explorer, Firefox, Safari, Chrome, or Opera) and go to URL/domain name <http://tew-821dap> or IP address <http://192.168.10.100>. Your router will prompt you for a user name and password.



2. You can find the **Password** on a sticker on the side of the router and on the label on the bottom of the router.

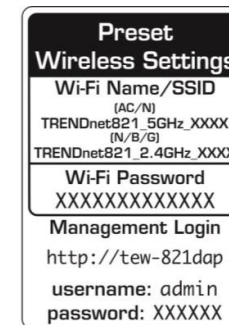

3. Enter your **Username** and **Password**, select your preferred language, and then click **Login**.

TEW-821DAP LOGIN	
User Name :	<input type="text" value="admin"/>
Password :	<input type="password" value="....."/>
Language :	<input type="text" value="English"/>
<input type="button" value="Login"/>	

## Operating Modes

This section outlines the available operating modes available on the access point.

1. Log into your management page (see "[Access the management page](#)" on page 13).
2. Click on **System** and **Operation Mode**.

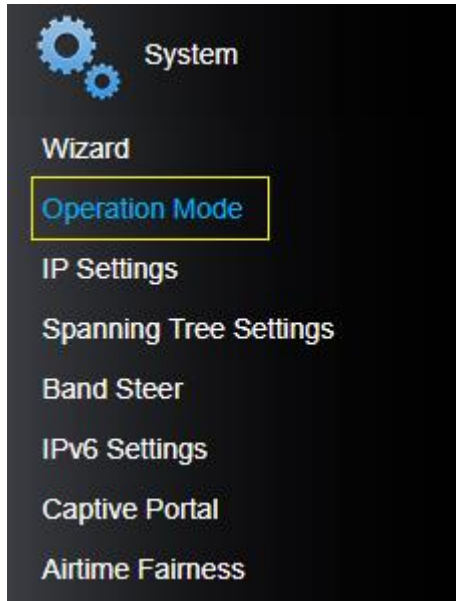

3. Select the operating mode to apply on each wireless band.
4. Click on **Save** button located on the bottom to save the settings, and click on **Apply/Discard** button located on the top left section to apply the saved settings.



Operation Mode	<b>2.4GHz Configuration</b> <input type="radio"/> Access Point <input type="radio"/> Client Bridge <input type="radio"/> WDS Access Point <input type="radio"/> Repeater <input type="radio"/> WDS Bridge <input type="radio"/> WDS Station
	<b>5GHz Configuration</b> <input type="radio"/> Access Point <input type="radio"/> Client Bridge <input type="radio"/> WDS Access Point <input type="radio"/> Repeater <input type="radio"/> WDS Bridge <input type="radio"/> WDS Station

- **Access Point:** In this mode, the device creates a wireless network to your existing network.
- **Client Bridge:** Select this mode to allow the access point the ability to wireless connect to your wireless network. This is similar to a wireless laptop or mobile device connecting to a wireless network.
- **WDS Access Point:** In the mode, the access point connects to other WDS bridge enable devices for backbone communication and provides wireless connection to clients (STAs) at the same time.
- **WDS Bridge:** When this mode is selected the access point connects ONLY to other WDS bridge enabled devices and local networks (the other wireless interface and Ethernet interface) as a wireless backbone bridge.
- **WDS Station:** The wireless interface connects to other WDS bridge enabled devices for backbone communication and connects to other wireless access points at the same time. Use this mode to pair with the next hop access point as a WDS network outlet.  
*Note: Please note that only one bridge can be set up on 2.4GHz or 5.0GHz band, but not both.*
- **Repeater:** In this mode, the wireless interface repeats wireless signal and packets for backbone communication as well as a client access. This feature is used to expand your existing wireless network to areas that your current access point is unable to reach. Make sure all of the settings of the wireless interface matches to your root or connecting wireless access points, same SSID, channel and wireless encryption settings.



## Access Point



### Basic

Wireless (2.4GHz or 5GHz) > Wireless Network

This section outlines the available features to configure for both wireless 2.4GHz and 5GHz when Access Point mode is selected.

1. Log into your management page (see [“Access the management page”](#) on page 13).
2. Click on the wireless band you would like to configure and click **Wireless Network**.



3. Configure the below settings and click **Save** to save settings.

Wireless Mode	2.4GHz 802.11 b/g/n mixed mode
Channel Width	Auto 20/40 MHz
Extension Channel	Auto
Frequency (Channel)	Ch4 - 2427MHz
AP Detection	Scan

4. Click on **Apply/Discard Changes** button located on the top left section to apply settings.

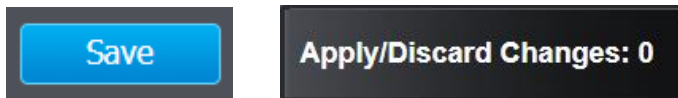

- **Wireless Mode:** If all of the wireless devices you want to connect with this Access Point can connect in the same transmission mode, you can improve performance slightly by choosing the appropriate mode. If you have some devices that use a different transmission mode, choose the appropriate mode.

#### 2.4GHz Wireless

- **B/G/N mixed:** Select this mode for the best compatibility. This mode allows older 802.11b and 802.11g wireless devices to connect to the access point in addition to newer 802.11n devices.
- **B/G mixed:** This mode only allows devices to connect to the access point using older and slow 802.11b or 802.11g technology and it thereby reduces the router's maximum speed to 54Mbps (typically not recommended).
- **N only:** This mode only allows newer 802.11n devices to connect to your access point. This mode does ensure the highest speed and security for your network, however, if you have older 802.11g wireless clients, they will no longer be able to connect to this router.
- **G only:** This mode only allows devices to connect to the access point using older and slower 802.11g technology (typically not recommended).
- **B only:** This mode only allows devices to connect to the access point using older and slower 802.11b technology (typically not recommended).

**Note:** Please check the specifications on your wireless devices for the highest wireless capability supported first before applying these settings. If you are unsure, it is recommended that you keep the default setting (B/G/N mixed) for the best compatibility.

#### 5GHz Wireless

- **A only:** This mode only allows devices to connect to the access point using older and slower 802.11a technology (typically not recommended).
- **A/N mixed:** This mode only allows devices to connect to the access point using older and slower 802.11a or 802.11n technology and it thereby reduces the access point's maximum speed to 54Mbps (typically not recommended).
- **N only:** This mode only allows newer 802.11n devices to connect to your access point. This mode does ensure the highest speed and security for your network, however, if you have older 802.11a wireless clients, they will no longer be able to connect to this router.
- **N/AC mixed:** Select this mode for the best compatibility. This mode allows older 802.11a wireless devices to connect to the access point in addition to newer 802.11ac devices.

- **AC only:** This mode only allows devices to connect to the access point using newer and faster 802.11ac technology (typically not recommended).
- **A/N/AC mixed:** Select this mode for the best compatibility. This mode allows older 802.11a and 802.11n wireless devices to connect to the access point in addition to newer 802.11ac devices.

**Note:** Please check the specifications on your wireless devices for the highest wireless capability supported first before applying these settings. If you are unsure, it is recommended that you keep the default setting (A/N/AC mixed) for the best compatibility.

When applying the 802.11 mode setting, please keep in mind the following:

- Wireless devices that support 802.11n are backwards compatible and can connect wirelessly at 802.11g or 802.11b.
- Connecting at 802.11b or 802.11g will limit the capability of your 802.11n supported wireless devices from obtaining higher performance and data rates.
- Allowing 802.11b or 802.11g devices to connect to an 802.11n capable wireless network may degrade the wireless network performance below the higher performance and data rates of 802.11n.
- Wireless devices that only support 802.11b or 802.11g will not be able to connect to a wireless network that is set to 802.11n only mode.
- Wireless devices that only support 802.11b will not be able to connect to a wireless network that is set to 802.11g only mode.
- **Channel Width:** Select the channel width for the access point to operate on. By default, the access point is on Auto 20/40 MHz.
- **Extension channel:** When 20/40 channel bandwidth has been chosen, you should select extension channel to get higher throughput.
- **Frequency (Channel):** In North America, this router can broadcast on 1 of 11 Channels for 2.4GHz (13 in Europe and other countries). Selecting the Auto option enables the router to automatically select the best Channel for wireless communication. To manually set the channel on which the router will broadcast, click the drop-down list and select the desired Channel for wireless communication. The goal is to select the Channel that is least used by neighboring wireless networks.

## Wireless Profile

Wireless (2.4GHz or 5GHz) > Wireless Network

This section outlines the available features to configure for both wireless 2.4GHz and 5GHz when Access Point mode is selected.

1. Log into your management page (see "[Access the management page](#)" on page 13).
2. Click on the wireless band you would like to configure and click **Wireless Network**.



3. Underneath the basic wireless band section, you will see **Wireless Network** and all your wireless network profiles will be listed.
4. Click on the Edit button next to the wireless profile you want to configure.

Current Profiles			
Enable	SSID	Security Mode	Edit
<input checked="" type="checkbox"/>	TRENDnet821_2.4GHz_0045	WPA2-PSK AES	<a href="#">Edit</a>

5. Review the wireless settings, click **Save** and **Apply/Discard Changes** when finished.

Wireless Settings	
SSID	TRENDnet821_2.4GHz_C9B6
Hide SSID	<input type="checkbox"/>
Separate Stations	<input type="checkbox"/>
Enable	<input checked="" type="checkbox"/>

- **SSID:** Enter the wireless network name (SSID) to assign to the selected wireless profile
- **Hide SSID:** Select option to disable the wireless network name to broadcast
- **Separate Stations:** Select this option to restrict wireless client devices from accessing other client devices connected to this network(s).

- **Enable:** Select this option to enable this SSID

## Wireless MAC filter

*Wireless (2.4GHz or 5GHz) > Wireless MAC Filter*

Every network device has a unique, 12-digit MAC (Media Access Control) address. Using wireless MAC filters, you can allow or deny specific wireless clients using this access point's wireless network.

1. Log into your management page (see "[Access the management page](#)" on page 13).
2. Click on the wireless band you would like to configure and click **Wireless MAC Filter**.

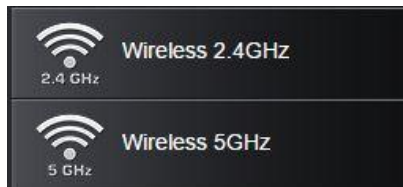

3. Review the settings and click **Save** and **Apply/Discard Changes** button to save settings.

Wireless MAC Filter	
Filter Mode	DENY listed computers access and allow all others
MAC Address	<input type="text"/> (Ex: 00:11:22:33:44:55)

- **Filter Mode:** Select from the pull-down list the MAC filter rule to apply.
  - **Disable:** Select to turn off MAC filter feature
  - **DENY:** Select this option to DENY all listed MAC addressed
  - **ALLOW:** Select this option to only ALLOW the listed MAC address to the network.
- **MAC Address:** Enter the MAC address to apply on the MAC filter rule

## MAC Filter List

MAC Filter List	
MAC	Delete
00:33:22:44:55:55	

- **MAC:** List of all MAC addresses

- **Delete:** Click to remove the selected MAC address from the MAC Filter List

## Band Steering

*System > Band Steering*

When both 2.4GHz and 5GHz bands are using the same SSID and WiFi security settings, this feature allows the AP to automatically detect if clients are 11AC capable and automatically pushing them over to the underutilized 5GHz bands. This allows your AP to use both bands more efficiently and making sure clients capable of the 11AC standard for faster speeds are establish WiFi links at 11AC connectivity whenever possible.

1. Log into your management page (see "[Access the management page](#)" on page 13).
2. Click on the **System** tab and click **Band Steer**.
3. Select enable to turn on band steering feature and click **Save** to save settings.

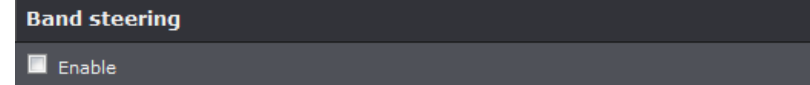

4. Click on **Save** button to save the settings and then click on the **Apply/Discard Changes** button located on the top left section to save the settings.

To enable band steering, you have to setup steering SSID the same in both 2.4GHz and 5GHz

**Apply/Discard Changes: 0**

## Airtime Fairness

System > Airtime Fairness

This is an optional setting that will provide higher speed WiFi clients with higher traffic priority when competing for wireless bandwidth with slower speed clients. This can provide increased network performance by preventing higher speed clients from waiting for slower speed clients to completely data transfers before utilizing WiFi bandwidth.

**Note:** Airtime Fairness priority (highest to lowest): 802.11ac > 802.11n > 802.11a/g > 802.11b

1. Log into your management page (see "[Access the management page](#)" on page 13).
2. Click on the **System** tab and click on **Airtime Fairness**.
3. Check the **Enable** check box and click **Save** to enable the airtime fairness feature.

Airtime Fairness	
Enable	<input checked="" type="checkbox"/>

4. Click on **Save** button to apply the settings and then click on the **Apply/Discard Changes** button located on the top left section to save the settings.

<b>Apply/Discard Changes: 0</b>
---------------------------------

## Roaming Support (802.11k)

Wireless (2.4GHz or 5GHz) > Wireless Network

The 802.11k standard is an enhancement to wireless roaming technology. It allows wireless access points to exchange and learn information about other access points on the network such as signal strength and client utilization and provide this information to 802.11k capable wireless client devices. Wireless client devices can use the information about other wireless network and make more intelligent decisions when roaming from one wireless access point to another. This also assists in better access point client utilization. **Note:** This function can only work with 802.11k capable wireless client devices. Please check your device specifications with your manufacturer for details.

1. Log into your management page (see "[Access the management page](#)" on page 13).
2. Click on **Wireless (2.4GHz or 5GHz)**, and click **Wireless Network**.
3. Under the Current Profiles section, click **Edit** for the profile you would like to configure.

Current Profiles			
Enable	SSID	Security Mode	Edit
<input checked="" type="checkbox"/>	TRENDnet821_2.4GHz_0045	WPA2-PSK AES	<a href="#">Edit</a>

4. Under the Roaming Assistant section, check the **802.11k support** option to enable 802.11k support. The Scan Period defines how often the access point will scan for information about other access points on the wireless network.

Roaming Assistant	
802.11k Support	<input checked="" type="checkbox"/>
Scan Period	10 minutes

5. Click on **Save** button to apply the settings and then click on the **Apply/Discard Changes** button located on the top left section to save the settings.

<b>Apply/Discard Changes: 0</b>
---------------------------------

## RSSI Scanner

System > Wireless (2.4GHz or 5GHz) > Wireless RSSI Scanner

The RSSI scanner feature allows the access point to scan for the signal strength of wireless client devices that currently connected and configured to automatically disconnect the wireless devices once signal strength and connectivity reach a specified limit. In a wireless roaming network with multiple access points, this can assist by forcing the disconnection of the wireless client device before signal strength and connectivity to the AP are too low to sustain enough bandwidth for Internet streaming applications. This will force the wireless client device to connect to an AP strong signal and connection rate relative to its new location. It is the nature of wireless client devices to maintain connectivity to the currently connected wireless network as long as the signal can still be discovered.

In the example diagram, you can see that the further away the client device is from the AP, the lower signal strength. (-30 RSSI is a higher strength value relative the AP compared to -90 RSSI). The client device at -90 RSSI is closer to the next AP but without the forced disconnection from the AP on the left using the RSSI scanner function, the client device would remain connected to the much further AP on the left than stronger signal AP on the right. Forcing a disconnect from the originally connected AP on the right would force the client to connect to the much higher signal strength AP on the right providing better connectivity during the transition between physical locations.

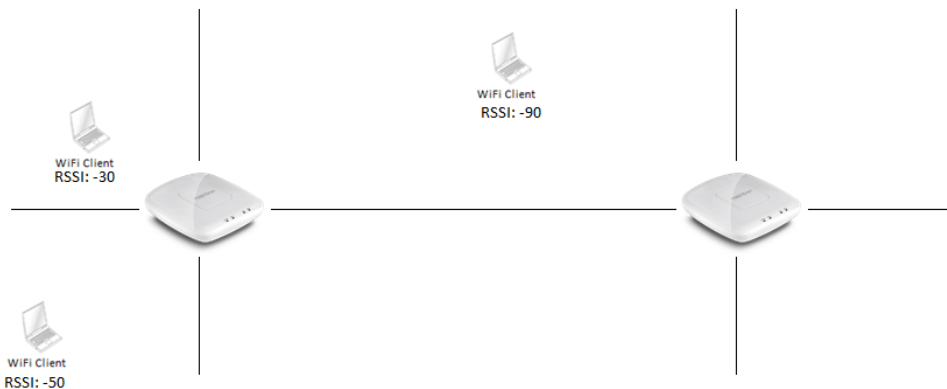

1. Log into your management page (see "[Access the management page](#)" on page 13).
2. Click on **Wireless (2.4GHz or 5GHz)**, and click **Wireless RSSI Scanner**.

3. Under the Current Profiles list, tick the SSID to enable the RSSI scanner feature.

- **RSSI Value:** First select the minimum RSSI value (client signal strength) before the AP disconnects the client (-30dBm is better signal strength than -90dBm).
- **Tolerance:** Then select the tolerance or action once the AP detects the specified signal strength of the client device is reached.
  - **Kick immediately** – This setting will immediately disconnect the client once the specified RSSI value is reached
  - **Detect # seconds** – Once the specified RSSI value is reached for a client device, this setting will check the client device signal strength again after the selected number of seconds. If the signal strength is still at the specified RSSI value or less, the client will be disconnected.

Current Profiles			
Enable	SSID	Tolerance	RSSI value
<input type="checkbox"/>	TRENDnet821_2.4GHz_0045	kick immediately ▼	-90 ▼ dBm
<input type="checkbox"/>		kick immediately ▼	-90 ▼ dBm

5. Click on **Save** button to apply the settings and then click on the **Apply/Discard Changes** button located on the top left section to save the settings.

Save/Reload: 0

## IPv6 Settings

System > IPv6 Settings

1. Log into your management page (see "[Access the management page](#)" on page 13).
2. Click on the **System** tab and click **IPv6 Settings**.

IPv6 Connection Type	
Choose the mode to be used by the AP to connect to the IPv6 Internet.	
My IPv6 Connection is	<div style="border: 1px solid black; padding: 2px;">           Local Connectivity Only ▼            Local Connectivity Only            Static IPv6            Autoconfiguration (SLAAC/DHCPv6)         </div>

3. Choose your IPv6 Connection Type.
4. When you are finished configuring the IPv6 Settings, click on **Save** to save your changes and the **Apply/Discard Changes** button to apply the settings.

## Static IPv6

Static IPv6 are static IP addresses that are usually provided by your Internet Service Provider (ISP).

1. Review the Static IPv6 settings below.

LAN IPv6 ADDRESS SETTINGS	
Enter the information provided by your Internet Service Provider (ISP).	
LAN IPv6 Address	<input type="text"/>
Subnet Prefix Length	<input type="text" value="0"/>
Default Gateway	<input type="text"/>
Primary DNS Server	<input type="text"/>
Secondary DNS Server	<input type="text"/>

**LAN IPv6 Address:** Enter the IPv6 IP address provided to you by your Internet Service Provider (ISP)

**Subnet Prefix Length:** Enter the prefix length of your subnet mask

**Default Gateway:** Enter the default gateway of your Internet Service Provider (ISP)

**Primary DNS Server / Secondary DNS Server:** Enter the Primary and Secondary DNS server provided to you by your local Internet Service Provider (ISP)

## Auto Configuration (SLAAC/DHCPv6)

1. Review the IPv6 DNS Settings below.

IPv6 DNS SETTINGS	
Obtain DNS server address automatically or enter a specific DNS server address.	
<input type="radio"/>	Obtain IPv6 DNS server address automatically
<input checked="" type="radio"/>	Use the following IPv6 DNS servers
Primary DNS Server	<input type="text"/>
Secondary DNS Server	<input type="text"/>

2. Select either **Obtain IPv6 DNS server address automatically** or **Use the following IPv6 DNS Servers**.

- **Obtain IPv6 DNS server address automatically:** Selecting this option will allow the access point to automatically search for the DNS server address that is provided by your Internet Service Provider (ISP)
- **Use the following IPv6 DNS Servers:** Selecting this option enables you to manually input the Primary and Secondary DNS Servers

## Change your IP address

*System > IP Settings*

In most cases, you do not need to change the IP address settings. Typically, the IP address settings only needs to be changed, if you plan to use another access point in your network with the same IP address settings, if you are connecting your access point to an existing network that is already using the IP address settings your access point is using.

**Note:** If you are not encountering any issues or are not faced with one of the cases described above or similar, it is recommended to keep your router IP address settings as default.

Default Access Point IP Address: 192.168.10.100 / 255.255.255.0

1. Log into your management page (see "[Access the management page](#)" on page 13).
2. Click on the **System** tab and click **IP Settings**.
3. Review the settings and click **Save** to save changes.

LAN Connection Type	
Connection Type	DHCP ▾
DNS Server Setting	
Primary DNS Server	<input type="text"/>
Secondary DNS Server	<input type="text"/>

- **Connection Type:** Select on the pull-down menu the LAN connection type.
    - **DHCP:** Select this option to have the access point obtain an IP address from your DHCP server
    - **STATIC:** Select this option to manually assign and IP address to your access point
  - **DNS Server:** Enter your network's DNS server IP address
4. Click on **Save** button to apply the settings and then click on the **Apply/Discard Changes** button located on the top left section to save the settings.

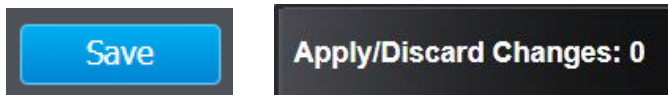

## Captive Portal

*System > Captive Portal*

The captive portal feature allows you to provide customized authentication typically for public WiFi users and guest user authentication. Captive Portal authentication for WiFi is typically used in areas such as hotel lobbies, airports, coffee shops and other WiFi hot spots. The access points supports both captive portal authentication through the built-in user account database and basic portal customization or CoovaChilli which is an open-source implementation of captive portal (UAM) function and 802.1X RADIUS (please note CoovaChilli requires an external CoovaChilli server which must be preconfigured to work and authenticate requests through the access point). You may want to disable standard WiFi security methods on the selected SSIDs such as WEP/WPA/WPA2 in order to use the captive portal authentication method instead. Before applying captive portal functionality to select wireless profiles, the captive portal type must be configured first along with all required parameters.

Select the captive portal mode:

- **Internal Captive Portal** – This mode allows you to authenticate requests through the built-in user account database and apply basic customization to the captive port user login page. This option is recommended and does not require an external authentication server.
- **Redirect URL** – This mode requires no authentication and allows redirection of users to a specific website/URL.
- **Captive Portal with RADIUS (CoovaChilli)** – This mode requires an external CoovaChilli server to be configured to provide the captive portal user login page and authenticate request through the access point.

### Captive Portal with RADIUS (CoovaChilli)

Assuming your external CoovaChilli server has been installed and configured to authenticate requests through the access point.

1. Log into your management page (see "[Access the management page](#)" on page 13).
2. Click on the **System** tab and click **Captive Portal**.
3. Choose the Captive Portal mode **Captive Port with RADIUS**.

Mode	
Select Mode	Captive Portal with Radius ▾

4. Check the **Enable** option for the **Enable Captive Portal** setting to enable the captive portal feature. Tick which SSIDs to apply and require the captive portal authentication function.

Which wifi(s) support Captive Portal	
Enable Captive Portal	<input checked="" type="radio"/> Enable <input type="radio"/> Disable
2.4G	5G
<input type="checkbox"/> SSID #1 : TRENDnet821_2.4GHz_0045	<input type="checkbox"/> SSID #1 : TRENDnet821_5GHz_0045
<input type="checkbox"/> SSID #2 : (Off)	<input type="checkbox"/> SSID #2 : (Off)
<input type="checkbox"/> SSID #3 : (Off)	<input type="checkbox"/> SSID #3 : (Off)
<input type="checkbox"/> SSID #4 : (Off)	<input type="checkbox"/> SSID #4 : (Off)
<input type="checkbox"/> SSID #5 : (Off)	<input type="checkbox"/> SSID #5 : (Off)
<input type="checkbox"/> SSID #6 : (Off)	<input type="checkbox"/> SSID #6 : (Off)
<input type="checkbox"/> SSID #7 : (Off)	<input type="checkbox"/> SSID #7 : (Off)
<input type="checkbox"/> SSID #8 : (Off)	<input type="checkbox"/> SSID #8 : (Off)

5. Enter the CoovaChilli server settings. **Primary RADIUS Server** – Enter the IP address of the external CoovaChilli authentication server.

- **Secondary RADIUS Server** – If you have secondary or backup CoovaChilli authentication server, enter the IP address.
- **RADIUS Auth Port** – Enter the port number used by the Coovachilli server for authenticating RADIUS requests. The default port number used for RADIUS authentication is 1812.
- **RADIUS Acct Port** – Enter the port number used by the Coovachilli server for accounting on the server. The default port number for RAIDUS accounting is 1813.
- **RADIUS Shared Secret** – Enter the shared secret used to allow the CoovaChilli server to allow the access point to authentication RADIUS authentication requests.
- **RADIUS NAS ID:** Enter the NAS ID required by the CoovaChilli server to allow the access point to authentication RADIUS authentication requests.
- **UAM Portal URL** – Enter the UAM portal web URL address of the login authentication page provided by the CoovaChilli server.
- **UAM Secret** – Enter the UAM secret required to allow access to this portal page.

RADIUS Settings	
Primary RADIUS Server:	<input type="text"/>
Secondary RADIUS Server:	<input type="text"/>
RADIUS Auth Port:	<input type="text" value="1812"/>
RADIUS Acct Port:	<input type="text" value="1813"/>
RADIUS Shared Secret:	<input type="text" value="....."/>
RADIUS NASID:	<input type="text" value="nas01"/>
UAM Setting	
UAM Portal URL:	<input type="text"/>
UAM Secret:	<input type="text" value="....."/>

6. Click on **Save** button to apply the settings and then click on the **Apply/Discard Changes** button located on the top left section to save the settings.

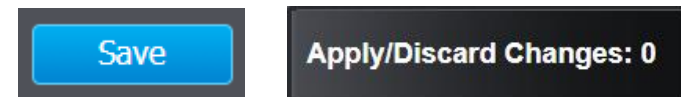

### Internal Captive Portal

**Note:** The internal captive portal function works on HTTP web port 80. Once enabled, in order to log back in to the access point management page, when prompted for credentials in the captive portal page, enter the access point administrator user name and password (default: admin / admin). After you have logged into the captive portal page with the access point administrative account, you will be redirected to the main access point management page for device configuration.

1. Log into your management page (see "[Access the management page](#)" on page 13).
2. Click on the **System** tab and click **Captive Portal**.
3. Choose the Captive Portal mode **Internal Captive Portal**.

Mode	
Select Mode	<input type="text" value="Internal Captive Portal"/>



First, enable Captive Portal, enter user name and password accounts for users to authenticate and set an authentication timeout value. Then click **Save** at the bottom of the page to save the settings.

Select the Login Method for connecting to your captive portal WiFi network. At the **Login Method** drop-down list, select one of the following.

Login Method	User name and password ▼
--------------	--------------------------

- **User name and password** – Requires users to enter a user name and password for authentication to connect to your captive portal WiFi network which must be defined in the **Users List**.

**Note:** Multiple users can use the same user account to log into your captive portal WiFi network.

- To create a new user account, next to **Setting Username and Password**, enter the user name and password for the new user account and click **Add**. Repeat to add more user accounts.

Setting Username and Password			
User Name	Password	Add User	
<input type="text"/>	<input type="password"/>	<input type="button" value="Add"/>	
Users List			
#	User Name	User Password	Delete User
1	user	user	<input type="button" value="Delete"/>

- **Single password** – Requires users to enter a single password to connect your captive portal WiFi network which must be defined in the **Setting Single Password** settings.
  - To specify a single password, next to **Setting Single Password**, enter the new password or click **Generate** to randomly generate a new password.

### Setting Single Password

<input type="text" value="abcde12345"/>	<input type="button" value="Generate"/>
---	---

- **Both** – Users can enter either a user name and password or single password to connect to your captive portal WiFi network. Both prompts will be displayed on the captive portal page and user can select either method to authenticate.
- Next, specify the **Authentication Timeout** settings. This is the session time period (minutes) which users are allowed to be logged in to your wireless network. Once the time expires, users will automatically logged and will need to log back in through the captive portal page again in order to reconnect to your wireless network. It is recommended to set a value to ensure authentication sessions are closed after a certain time period. Setting the value to 0 minutes allows users to be authenticated and connected to your captive portal WiFi network without any time restrictions.

Authentication Timeout	User name and password: <input type="text" value="60"/> Minute
	Single Password: <input type="text" value="30"/> Minute

Click **Save** when you have completed these settings.

- After your users authenticate and connect to your captive portal WiFi network, you may want to redirect your users to a specific URL, address, or website for advertisement purposes.

To enable this feature on your captive portal WiFi network, click the **Redirect** drop-down and select **Enable**. Enter the URL/address/website in the field **Redirect URL**. Click **Save** at the bottom of the page to save the settings.

**Note:** The prefix `http://` or `https://` must be included when entering URLs/addresses/websites (ex. <https://www.trendnet.com>)

Redirect	Enabled ▼
Redirect URL	<input type="text" value="https://www.trendnet.com"/>

After you have defined the initial parameters, you can apply portal page customization. Under Upload Image File, click **Browse** or **Choose File** depending on your browser, and navigate to the directory where the selected image is located and select the image. Once you have selected the image, click **Upload**.

Once you have uploaded the image, an image preview will appear and you can assign the image **Set as background** or **Set as logo**. If you would like to delete the image and upload a different image, you can also click **Delete** to delete the image.

**Note:** Only 2 images can be uploaded for portal page customization (Only one image can be set for the portal page background and another image can be set for the company/organization logo). Images are automatically scaled when uploaded. The recommended image formats are JPG, PNG, GIF. Maximum file size for images is 250KB.

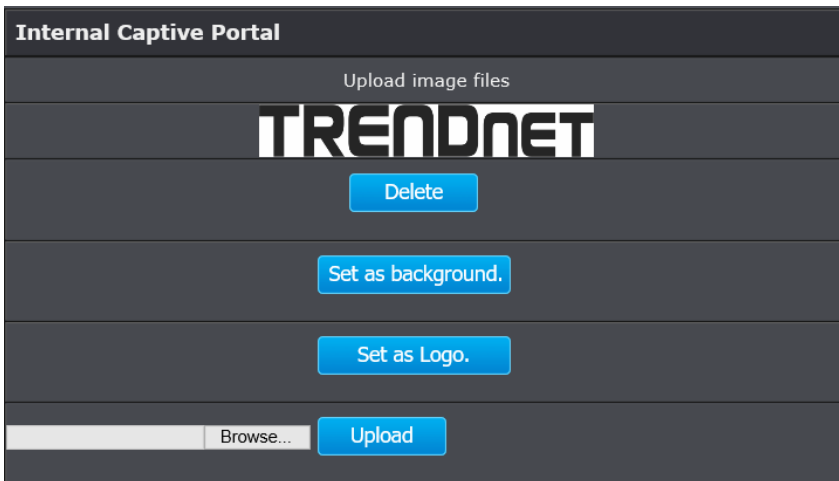
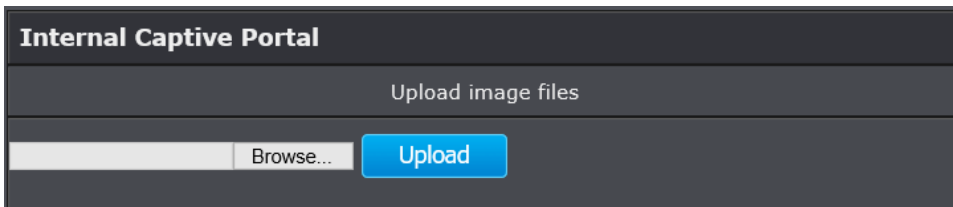

After you have uploaded your images, you can add a welcome or greeting message to display to your guest users on the captive portal page. A preview of the page and text will also be displayed. After you have finished entering your message, click **Save** at the bottom of the page to save the settings.

**Note:** Aside from text, you can enter HTML tags for text formatting and styles.

Below is an example of a greeting message formatted in html.

```
<br><br><br>
```

```
<p style="color:white;font-family:verdana;text-align:center;">
```

```
Welcome to TRENDnet WiFi access!
```

```
Please enter your account information for Internet access. Happy surfing!
```

```
</p>
```

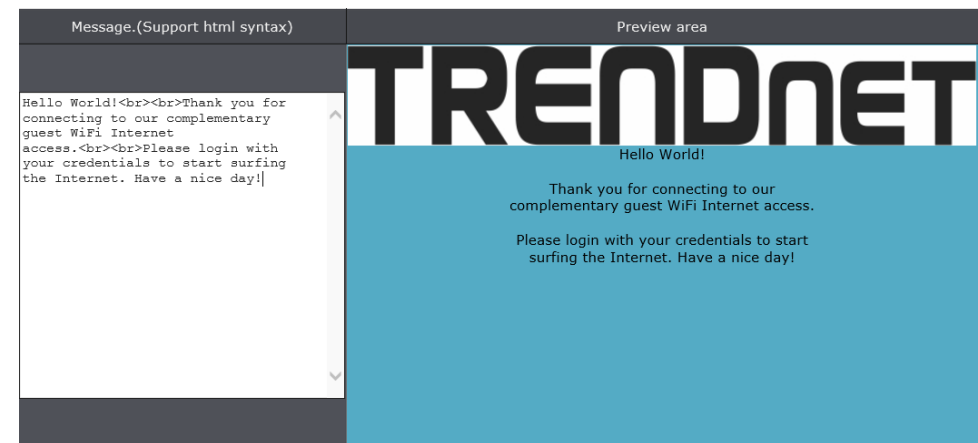

Additionally, you can modify the text displayed to your users for your terms of service. By default, a generic terms of service statement is provided for reference.

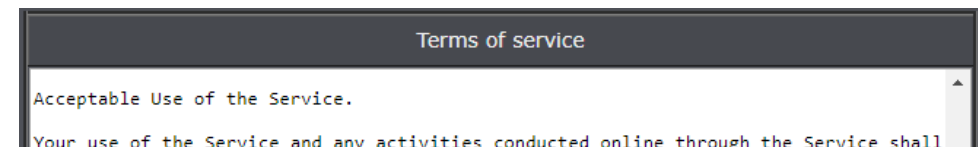

To apply captive portal authentication to a wireless SSID, under 2.4G or 5G, select which SSIDs captive portal authentication should be applied, then click **Save** at the bottom of the page to save the settings.

**Note:** The SSIDs must be enabled and configured under Wireless > 2.4G or 5G to be assigned. If using Captive Portal authentication, it is recommended to set the Authentication method to None in the wireless SSID settings since captive portal authentication will be used instead. If the Authentication Method is left enabled, the users will need to authenticate twice, once with the authentication method defined and also captive portal authentication.

2.4G	5G
<input type="checkbox"/> SSID #1 TRENDnet821_2.4GHz_0045	<input type="checkbox"/> SSID #1 TRENDnet821_5GHz_0045
<input type="checkbox"/> SSID #2 (off)	<input type="checkbox"/> SSID #2 (off)
<input type="checkbox"/> SSID #3 (off)	<input type="checkbox"/> SSID #3 (off)
<input type="checkbox"/> SSID #4 (off)	<input type="checkbox"/> SSID #4 (off)
<input type="checkbox"/> SSID #5 (off)	<input type="checkbox"/> SSID #5 (off)
<input type="checkbox"/> SSID #6 (off)	<input type="checkbox"/> SSID #6 (off)
<input type="checkbox"/> SSID #7 (off)	<input type="checkbox"/> SSID #7 (off)
<input type="checkbox"/> SSID #8 (off)	<input type="checkbox"/> SSID #8 (off)

Click on **Save** button to apply the settings and then click on the **Apply/Discard Changes** button located on the top left section to save the settings.

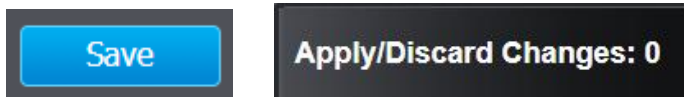

### Redirect URL

1. Log into your management page (see "[Access the management page](#)" on page 13).
2. Click on the **System** tab and click **Captive Portal**.
3. Choose the Captive Portal mode **Redirect URL**.

Mode	
Select Mode	Redirect URL ▾

First, enable Captive Portal, enter the URL/website to redirect users and set an authentication timeout value. Then click **Save** at the bottom of the page to save the settings.

- **Redirect** – Enables the redirect URL captive portal function.
- **Redirect URL** – This is the website or URL guest users will be automatically redirected after connecting to your wireless network through your captive portal page. (e.g. <https://www.trendnet.com>)
- **Authentication Timeout** – This is the session time period (minutes) which users are allowed to be logged in to your wireless network. Once the time expires, users will automatically be logged out and will need to log back in through the captive portal page again in order to reconnect to your wireless network. It is recommended to set a value to ensure authentication sessions are closed after a certain time period.

Redirect	Enabled ▾
Redirect URL	<a href="https://www.trendnet.com">https://www.trendnet.com</a>

## Create schedules

Management > Schedule

Create a schedule to define the days/time period when a feature should be active or inactive:

1. Log into your management page (see "[Access the management page](#)" on page 13).
2. Click on the **Management** tab and click **Schedule**.
3. Select from the pull-down menu under **Wireless Schedule** to **enable** wireless schedules.

Add Schedule Rule	
Wireless Schedule	<input type="button" value="Disable"/> <input type="button" value="Enable"/> <input type="button" value="Disable"/>

3. Review the settings and click **Add** to save settings.

Rule Name	<input type="text"/>
Service	<input type="radio"/> Reboot <input type="radio"/> 2.4GHz Wireless <input type="radio"/> 5GHz Wireless <input type="radio"/> Dual Wireless
Day(s)	<input type="radio"/> Select Day(s) <input type="radio"/> All Week
	<input type="checkbox"/> Sun <input type="checkbox"/> Mon <input type="checkbox"/> Tue <input type="checkbox"/> Wed <input type="checkbox"/> Thu <input type="checkbox"/> Fri <input type="checkbox"/> Sat
Start Time	00 : 00
End Time	00 : 00

- **Rule Name:** Enter desired schedule name.
  - **Service:** Allows you to set one of the actions either to Reboot the device, activate 2.4GHz or 5GHz or both bands.
  - **Day:** Check the day(s) to implement the schedule.
  - **Start Time:** Specify the time when this schedule will be in effect.
  - **End Time:** Specify the time when this schedule will end.
4. After clicking **Add**, click on the **Apply/Discard** button located on the top left section to save the settings.

**Apply/Discard Changes: 0**

## Configure Spanning Tree

1. Log into your management page (see "[Access the management page](#)" on page 13).
2. Click on the **System** tab and click **Spanning Tree Settings**.
3. Review the settings and click **Save** to save changes.

Spanning Tree Settings	
Spanning Tree Status	<input type="radio"/> ON <input checked="" type="radio"/> OFF
Bridge Hello Time	2 seconds(1-10)
Bridge Max Age	20 seconds(6-40)
Bridge Forward Delay	4 seconds(4-30)
Priority	32768 (0-65535)

- **Spanning Tree Status:** Select On or Off to enable or disable spanning tree feature.
- **Bridge Hello Time:** Enter the bridge duration
- **Bridge Max Age:** Enter the max duration
- **Bridge Forward Delay:** Enter the delay duration
- **Priority:** Enter the priority

4. Click on **Save** button to apply the settings and then click on the **Apply/Discard Changes** button located on the top left section to save the settings

**Save**

**Apply/Discard Changes: 0**

## Set date and time

Management > Time and Date Settings

There are two ways to set the access point's date and time. NTP (Network Time Protocol) is based on time servers. You can also manually set the router's date and time.

**Note:** It is important that the time is configured correctly before setting any schedules.

1. Log into your management page (see "[Access the management page](#)" on page 13).
2. Click on the **Management** tab and click **Time and Date Settings**.
3. Next to **Time Zone**, click the drop-down list to select your time zone.

Time Setting	
Time Zone	(GMT-05:00) Eastern Time (US & Canada) ▼

## Daylight Saving Time

When using NTP or manual configuration, you may also configure Daylight Saving feature.

Daylight Saving Time					
Enable Daylight Saving	<input checked="" type="checkbox"/>				
Daylight Saving Offset	+1:00 ▼				
Daylight Saving Dates	DST Start	Month	Week	Day of Week	Hour
	DST End	Month	Week	Day of Week	Hour
	Mar ▼	3rd ▼	Sun ▼	01 ▼	
	Nov ▼	2nd ▼	Sun ▼	01 ▼	

- **Enable:** Check option to enable daylight savings
- **Daylight Saving Offset:** Select the offset amount for daylight savings to apply
- **Start/End Time:** Configure the start and end time of daylight savings.

## NTP

1. Review the settings below and click **Save** to save settings.

NTP Settings	
Enable NTP Server	<input checked="" type="checkbox"/>
NTP Server	Select NTP Server ▼
NTP synchronization	300 (1~300) Minute

- **Enable:** Check option to enable NTP feature
- **NTP Server:** Select the NTP server to use
- **NTP synchronization:** Enter the time of when the access point will continue to check for NTP updates.

2. Click on **Save** button to apply the settings and then click on the **Apply/Discard Changes** button located on the top left section to save the settings.

<b>Save</b>	<b>Apply/Discard Changes: 0</b>
-------------	---------------------------------

## Manual

1. Manually set the date and time of the access point by select the from the pull-down menus.

Manually Set Time					
Year	2014 ▼	Month	Oct ▼	Day	17 ▼
Hour	17 ▼	Minute	04 ▼	Second	03 ▼

2. Click on **Save** button to apply the settings and then click on the **Apply/Discard Changes** button located on the top left section to save the settings.

<b>Save</b>	<b>Apply/Discard Changes: 0</b>
-------------	---------------------------------

## Management VLAN

Management > Management VLAN

1. Log into your management page (see "[Access the management page](#)" on page 13).
2. Click on the **Management** tab and click **Management VLAN**.
3. Review the settings for both 2.4G and 5G profiles and click **Save** to save settings.

2.4G Current Profiles			
Enable	VID	SSID	WiFi Security
<input type="checkbox"/>		TRENDnet825_2.4GHz_821D	WPA2-PSK AES

5G Current Profiles			
Enable	VID	SSID	WiFi Security
<input type="checkbox"/>		TRENDnet825_5GHz_821D	WPA2-PSK AES

- **Enable:** Check box of the selected SSID to enable VLAN feature
- **VID:** Enter the VID to assign on the selected wireless network
- **SSID:** Displays the available SSID
- **WiFi Security:** Displays the wireless security type of the wireless network

Management VLAN ID

No VLAN tag  
 Specified VLAN ID  (must be in the range 1 ~ 4094. )

- **No VLAN Tag:** Select this option to use no VLAN Tag
  - **Specified VLAN ID:** Select this option and enter the assigned VLAN ID.
4. Click on **Save** button to apply the settings and then click on the **Apply/Discard Changes** button located on the top left section to save the settings.

## Wireless Bandwidth Control

Wireless (2.4GHz or 5GHz) > Wireless Bandwidth Control

1. Log into your management page (see "[Access the management page](#)" on page 13).
2. Click on the **Wireless (2.4GHz or 5GHz)** tab and click **Wireless Bandwidth Control**.
3. Review the settings for both wireless bands (2.4GHz and 5GHz) and click **Save** to save settings.

Bandwidth Control Disabled ▾

Current Profiles				
Enable	SSID	Download MAX	Download	Upload Limit for Client
<input type="checkbox"/>	TRENDnet821_2.4GHz_C9B6	Limit for Client ▾	10m bps	1m bps
<input type="checkbox"/>		Limit for Client ▾	10m bps	1m bps
<input type="checkbox"/>		Limit for Client ▾	10m bps	1m bps
<input type="checkbox"/>		Limit for Client ▾	10m bps	1m bps
<input type="checkbox"/>		Limit for Client ▾	10m bps	1m bps
<input type="checkbox"/>		Limit for Client ▾	10m bps	1m bps
<input type="checkbox"/>		Limit for Client ▾	10m bps	1m bps
<input type="checkbox"/>		Limit for Client ▾	10m bps	1m bps

- **Bandwidth Control:** Select **Enable** to enable bandwidth control on this SSID
  - **SSID:** The SSID that the following limits will apply to
  - **Download MAX:** Choose to set a limit per client or limit shared with entire SSID
  - **Download:** Enter your network's inbound traffic limit
  - **Upload Limit for Client:** Enter your network's outbound traffic limit for the selected wireless band
4. Click on **Apply/Discard** button located on the top left section to apply settings.

## Enable SNMP

*Management > SNMP Settings*

SNMP (Simple Network Management Protocol) is a network management protocol used to monitor (read) and/or manage (write) multiple network devices on a network. This preconfigured external SNMP server.

1. Log into your management page (see "[Access the management page](#)" on page 13).
2. Click on the **Management** tab and click **SNMP Settings**.
3. Review the settings and click **Save** to save settings.

SNMP	<input checked="" type="radio"/> Enable <input type="radio"/> Disable
Contact	<input type="text"/>
Location	<input type="text"/>
Community Name (Read Only)	public
Community Name (Read/Write)	private
Trap Destination Address	<input type="text"/>
Trap Destination Community Name	public
SNMPv3	<input checked="" type="radio"/> v3Enable <input type="radio"/> v3Disable
User Name	admin
Auth Protocol	MD5 ▾
Auth Key (8-32 Characters)	12345678
Priv Protocol	DES ▾
Priv Key (8-32 Characters)	12345678
Engine ID	<input type="text"/>

- **SNMP:** Select enable to enable SNMP feature
- **Contact:** Enter the contact person or contact information for your access point.
- **Location:** Enter an assigned location for your access point.
- **Community Name (Read only):** Enter an assigned name for your access point.
- **Community (Read/Write):** Enter a public and private community name.
- **Trap Destination Address:** Enter the destination IP address of the SNMP trap.
- **Trap Destination Community Name:** Enter the name of the destination community
- **SNMPv3:** Select option to enable or disable SNMPv3
- **Username:** Enter the username

- **Auth Protocol:** Select from the pull down menu the authentication protocol to use
  - **Authentication Key:** Enter the authentication key
  - **Priv Protocol:** Select the private protocol
  - **Priv Key:** Enter the private key
  - **Engine ID:** Enter the engine name
4. Click on **Save** button to apply the settings and then click on the **Apply/Discard Changes** button located on the top left section to save the settings.

## SSH Management

*Management > SSH Management*

SSH (Secure SHell) is a form of a CLI (Command Line Interface), a user interface where commands can be sent to the access point in the form of successive lines of text (command lines).

1. Log into your management page (see "[Access the management page](#)" on page 16).
2. Click on the **Management** tab and click **SSH Management**.
3. Select ON and click **Save** to save settings.

SSH	<input checked="" type="radio"/> ON <input type="radio"/> OFF
-----	---

4. Click on **Save** button to apply the settings and then click on the **Apply/Discard Changes** button located on the top left section to save the settings.

<b>Save</b>	<b>Apply/Discard Changes: 0</b>
-------------	---------------------------------

## LED Controls

Management > LED Control

1. Log into your management page (see "[Access the management page](#)" on page 13).
2. Click on the **Management** tab and click **LED Control**.
3. Review the settings and click Save to save settings.

Power LED	<input checked="" type="radio"/> ON <input type="radio"/> OFF
LAN LED	<input checked="" type="radio"/> ON <input type="radio"/> OFF
2.4GHz LED	<input checked="" type="radio"/> ON <input type="radio"/> OFF
5GHz LED	<input checked="" type="radio"/> ON <input type="radio"/> OFF

- **Power LED:** Select On to leave Power LED on or Off option to turn off.
  - **LAN LED:** Select On to leave LAN LED on or Off option to turn off.
  - **2.4GHz LED:** Select On to leave wireless 2.4GHz LED on or Off option to turn off.
  - **5GHz LED:** Select On to leave wireless 5GHz LED on or Off option to turn off.
4. Click on the **Save** button to apply the settings and then click on the **Apply/Discard** button located on the top left section to save the settings.

## Client Bridge



## Basic

Wireless (2.4GHz or 5GHz) > Wireless Network

This section outlines the available features to configure for both wireless 2.4GHz and 5GHz when Access Point mode is selected.

1. Log into your management page (see "[Access the management page](#)" on page 13).
2. Click on **System**, and select **Operation Mode**.

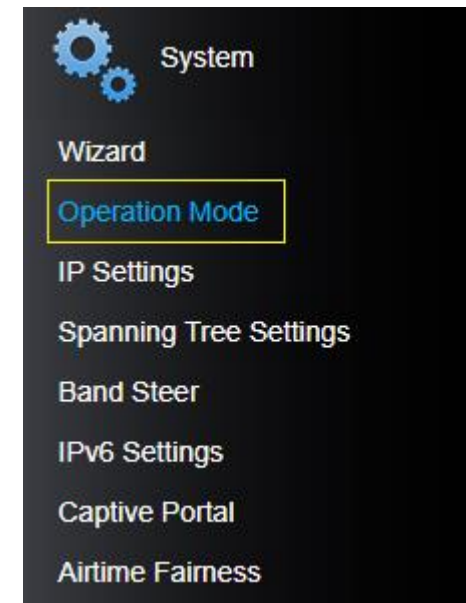



3. Enable **Client Bridge**, under the wireless band (2.4GHz or 5GHz) you would like to connect this access point to. Please make sure that the selected band is available on your network.

Device Name	TEW-821DAP
Operation Mode	<b>2.4GHz Configuration</b>
	<input type="radio"/> Access Point <input type="radio"/> Client Bridge <input type="radio"/> WDS Access Point <input type="radio"/> Repeater <input type="radio"/> WDS Bridge <input type="radio"/> WDS Station
	<b>5GHz Configuration</b>
	<input type="radio"/> Access Point <input type="radio"/> Client Bridge <input type="radio"/> WDS Access Point <input type="radio"/> Repeater <input type="radio"/> WDS Bridge <input type="radio"/> WDS Station
<input type="button" value="Save"/> <input type="button" value="Cancel"/>	

4. Click **Save** to save your current settings.
5. On the left-hand side menu, click on the wireless band tab (Wireless 2.4GHz / Wireless 5GHz) you would like to configure and click **Wireless Network**.

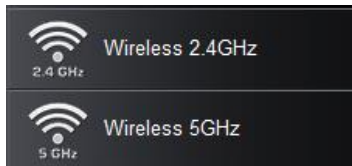

6. Configure the below settings and click **Save** and **Apply/Discard Changes** to save settings.

Wireless Mode	5GHz 802.11 a/n/ac mixed mode ▼
SSID	Enter the SSID/Wireless Network Name of the wireless network you would like to connect to in the field below or click Site Survey to scan for the available wireless networks to connect. <input type="text" value="AP SSID"/> <input type="button" value="Site Survey"/>
Preferred BSSID	<input type="checkbox"/> <input type="text"/>

- **Wireless Mode:** Select the wireless mode to set on the selected wireless band in client bridge mode
- **SSID:** Manually enter the wireless network name (SSID) you want to establish connection. Or simply click on **Site Survey** to scan for available wireless network (more details below).
- **Preferred BSSID:** Click option and enter the preferred wireless network you would like to connect to.

<b>Wireless Security</b>	
Security Mode	Disable ▼

- **Security Mode:** Select from the pull-down menu the wireless security that is used on the wireless network you would like to connect to.

## Scan for wireless networks

*Wireless (2.4GHz or 5GHz) > Wireless Network*

This section outlines the available features to configure for both wireless 2.4GHz and 5GHz when **Client Bridge** mode is selected.

1. Log into your management page (see "[Access the management page](#)" on page 13).
2. Click on the wireless band you would like to configure and click **Wireless Network**.



3. Under SSID section click **Site Survey** to wirelessly scan for available wireless networks.

SSID	BSSID	Channel	Signal Level	Type	Security	Mode
PortalTest	D8:EB:97:A2:87:4C	2	-49 dbm	802.11NG HT20	WPA2-PSK AES	AP
sonnytest	00:14:D1:BF:0B:37	1	-56 dbm	802.11NG HT20	WPA2-PSK AES	AP
TrendnetSkvN	00:14:D1:C5:7D:44	1	-76 dbm	802.11NG HT20	WPA2-PSK AES	AP
TrendnetOp	00:14:D1:B1:E1:B4	2	-80 dbm	802.11NG HT20	WPA2-PSK AES	AP
TrendnetOpWork	00:14:D1:B1:E1:B5	2	-81 dbm	802.11NG HT20	WPA2-PSK AES	AP
823_2.4GHz_itest	D8:EB:97:2A:CD:FE	1	-50 dbm	802.11NG HT20	WPA2-PSK AES	AP
TRENDnetGuest	00:14:D1:C6:A1:6E	4	-74 dbm	802.11NG HT20	WPA/WPA2-PSK TKIP/AES	AP

4. Click on the wireless network you would like to connect. The information will automatically fill on the previous screen. You will then need to select and enter the wireless security.

**Wireless Security**

Security Mode: WPA2-Personal

---

**WPA**

WPA Cipher: AES

Pre-Shared Key :

5. Click on **Save** button to apply the settings and then click on the **Apply/Discard Changes** button located on the top left section to save the settings.



WDS

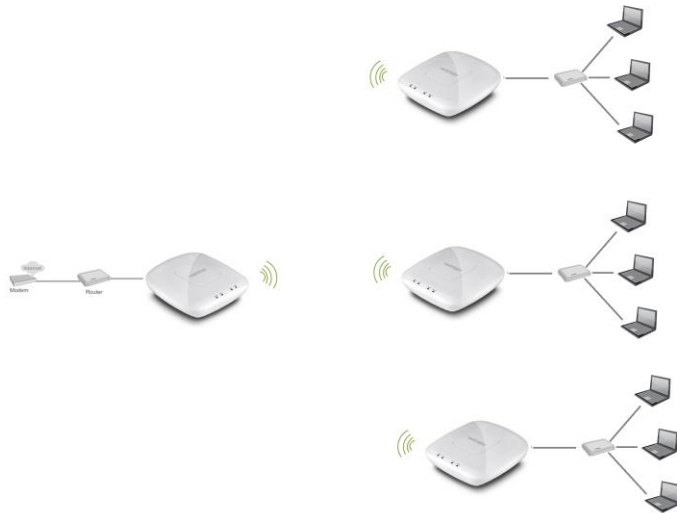

**WDS Link**

Wireless (2.4GHz or 5GHz) > WDS Link Settings

This section outlines the available features to configure for both wireless 2.4GHz and 5GHz when WDS mode is selected.

1. Log into your management page (see "[Access the management page](#)" on page 13).
2. Click on **System**, and select **Operation Mode**.
3. Enable **WDS Access Point**, under the wireless band (2.4GHz or 5GHz) you would like to connect this access point to. Please make sure that the selected band is available on your network.

Access Point
  Client Bridge
  WDS Access Point
  Repeater  
 WDS Bridge  
 WDS Station

4. Click on the wireless band you would like to configure and click **WDS Link Settings**.



5. Configure the below settings and click **Save** to save settings.

Wireless Distribution System(WDS)	
Local AP MAC Address	unavailable
Site Survey	<a href="#">Site Survey</a>
Remote AP MAC Address	<input type="text"/>
Remote AP MAC Address	<input type="text"/>
Remote AP MAC Address	<input type="text"/>
Remote AP MAC Address	<input type="text"/>

- **Site Survey:** Click this option to scan for available WDS networks
- **Remote AP MAC:** Enter the MAC address of the remote access point you want to establish WDS connection.

Wireless Security	
Security Mode	<input type="text" value="Disable"/>

- **Security Mode:** Select from the pull-down menu the wireless security that is used on the wireless network you would like to connect to.

6. Click on **Save** button to apply the settings and then click on the **Apply/Discard** button located on the top left section to save the settings.

**Apply/Discard Changes: 0**

## Repeater



### Basic

Wireless (2.4GHz or 5GHz) > Wireless Network

This section outlines the available features to configure for both wireless 2.4GHz and 5GHz when Repeater mode is selected.

1. Log into your management page (see "[Access the management page](#)" on page 13).
2. Click on **System**, and select **Operation Mode**.

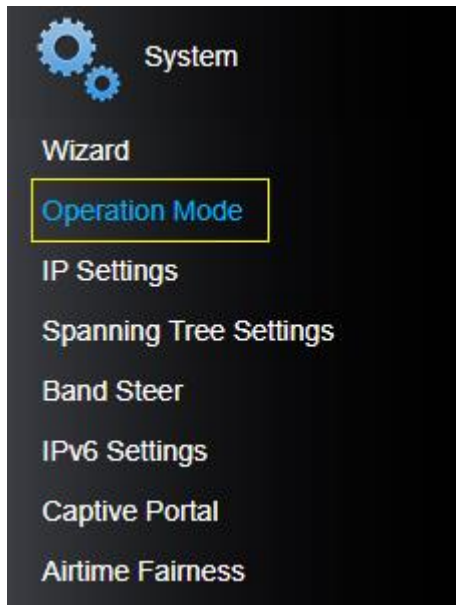

3. Enable **Repeater**, under the wireless band (2.4GHz or 5GHz) you would like to connect this access point to, then press **Save**. Please make sure that the selected band is available on your network.

Operation Mode	<b>2.4GHz Configuration</b> <input type="radio"/> Access Point <input type="radio"/> Client Bridge <input type="radio"/> WDS Access Point <input type="radio"/> Repeater <input type="radio"/> WDS Bridge <input type="radio"/> WDS Station
	<b>5GHz Configuration</b> <input type="radio"/> Access Point <input type="radio"/> Client Bridge <input type="radio"/> WDS Access Point <input checked="" type="radio"/> Repeater <input type="radio"/> WDS Bridge <input type="radio"/> WDS Station

4. Click on the wireless band (Wireless 2.4GHz / Wireless 5GHz) you would like to configure and click **Wireless Network**.



5. Configure the below settings and click **Save** to save settings.

Wireless Mode	5GHz 802.11 a/n/ac mixed mode ▼
SSID	Enter the SSID/Wireless Network Name of the wireless network you would like to connect to in the field below or click Site Survey to scan for the available wireless networks to connect. : AP SSID <input type="text"/> <input type="button" value="Site Survey"/>
Preferred BSSID	<input type="checkbox"/> <input type="text"/>
Repeater SSID	<input type="text"/>

- **Wireless Mode:** Select the wireless mode to set on the selected wireless band in client bridge mode

- **SSID:** Manually enter the wireless network name (SSID) you want to establish connection. Or simply click on **Site Survey** to scan for available wireless network (more on this function in below section).
- **Preferred BSSID:** Click option and enter the MAC address of the preferred wireless network you would like to connect to.
- **Repeater SSID:** You may specify a new SSID name to use

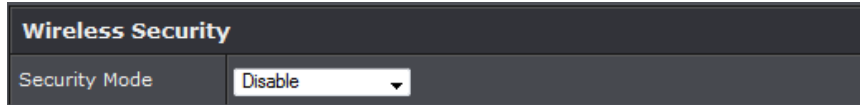

- **Security Mode:** Select from the pull-down menu the wireless security that is used on the wireless network you would like to connect to.

6. Click on the **Apply/Discard Changes** button located on the top left section to save the settings.

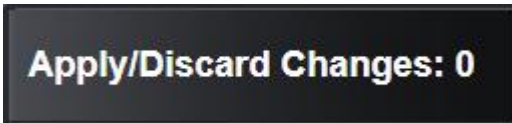

### Scan for wireless networks

*Wireless (2.4GHz or 5GHz) > Wireless Network*

This section outlines the available features to configure for both wireless 2.4Ghz and 5GHz when **Repeater** mode is selected.

1. Log into your management page (see "[Access the management page](#)" on page 16).
2. Click on the wireless band you would like to configure and click **Wireless Network**.

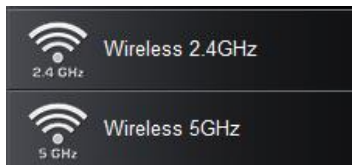

3. Under SSID section click Site Survey to wireless scan for available wireless networks.

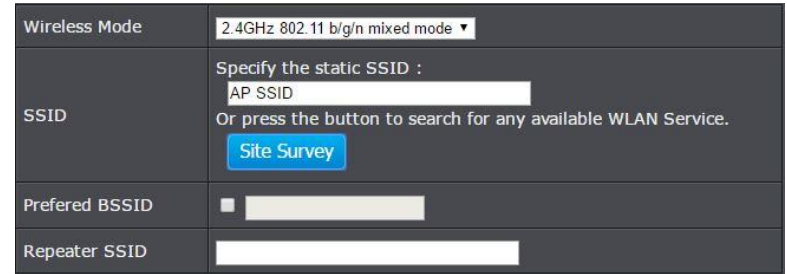

4. Click on the wireless network you would like to repeat. The information will automatically fill on the previous screen. You will then need to select and enter the wireless security.

SSID	BSSID	Channel	Signal Level	Type	Security	Mode
PortalTest	D8:EB:97:A2:87:4C	2	-49 dbm	802.11NG HT20	WPA2-PSK AES	AP
sonnytest	00:14:D1:BF:0B:37	1	-56 dbm	802.11NG HT20	WPA2-PSK AES	AP
TrendnetSkvN	00:14:D1:C5:7D:44	1	-76 dbm	802.11NG HT20	WPA2-PSK AES	AP
TrendnetOp	00:14:D1:B1:E1:B4	2	-80 dbm	802.11NG HT20	WPA2-PSK AES	AP
TrendnetOpWork	00:14:D1:B1:E1:B5	2	-81 dbm	802.11NG HT20	WPA2-PSK AES	AP
823 2.4GHz_itest	D8:EB:97:2A:CD:FE	1	-50 dbm	802.11NG HT20	WPA2-PSK AES	AP
TRENDnetGuest	00:14:D1:C6:A1:6E	4	-74 dbm	802.11NG HT20	WPA/WPA2-PSK TKIP/AES	AP

5. Click on **Save** button to apply the settings and then click on the **Apply/Discard Changes** button located on the top left section to save the settings.

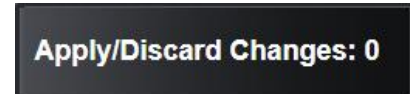

## Advanced wireless settings

Wireless (2.4GHz or 5GHz) > Advanced Wireless

1. Log into your management page (see "[Access the management page](#)" on page 13).
2. Click on the wireless band you would like to configure and click **Wireless Advanced Settings**.



3. Review the settings and click **Save** to save settings.

### Advanced Wireless

Advanced Wireless	
Data Rate	Auto
Transmit Power	Auto
RTS/CTS Threshold	2347 (range 1 - 2347, default 2347)
Beacon Period	100 ms (range 100 - 1000, default 100)
DTIM	1 (range 1 - 255, default 1)

- **Data Rate:** Select the operating wireless data rate.
- **Transmit Power:** The wireless transmit power can be modified to lower the antenna strength setting from 18 dBm to 11 dBm, if necessary. Lowering the wireless transmit power may help to better stabilize the wireless connectivity and reduce the effects of wireless interference in areas where there are several 2.4GHz wireless devices. (Default: 18 dBm)
- **RTS/CTS Threshold:** The Request To Send (RTS) function is part of the networking protocol. A wireless device that needs to send data will send a RTS before sending the data in question. The destination wireless device will send a response called Clear to Send (CTS). The RTS Threshold defines the smallest data packet size allowed to initiate the RTS/CTS function. Default Value: 2347 (range: 256-2346)
- **Beacon Period:** A beacon is a management frame used in wireless networks that transmitted periodically to announce the presence and provide information about

the access point's wireless network. The interval is the amount time between each beacon transmission.

- **DTIM:** DTIM is a countdown informing clients of the next window for listening to broadcast and multicast messages. When the access point has buffered broadcast or multicast messages for associated clients, it sends the next DTIM with a DTIM Interval value. Wireless clients detect the beacons and awaken to receive the broadcast and multicast messages. The default value is 1. Valid settings are between 1 and 255.

### HT Physical Mode

HT Physical Mode	
Guard Interval	<input checked="" type="radio"/> Auto <input type="radio"/> Long
A-MPDU	<input checked="" type="radio"/> Enable <input type="radio"/> Disable 32 Frames 50000 Bytes(Max)

- **Guard Interval:** Select to enable short guard interval (400ns).
- **A-MPDU:** MPDU aggregation also collects Ethernet frames to be transmitted to a single destination, but it wraps each frame in an 802.11n MAC header. Normally this is less efficient than MSDU aggregation, but it may be more efficient in environments to maintain performance in noisy networks and to prevent hidden nodes from degrading the performance.

### Client Limit

Client Limit	
Client Limit	<input checked="" type="radio"/> Enable <input type="radio"/> Disable
Max Client	48

- **Client Limit:** Select enable to turn on client limit of the select wireless band
- **Max Client:** Enter the amount of clients to allow

4. Click on **Apply/Discard Changes** button located on the top left section to apply settings.

Apply/Discard Changes: 0

## Maintenance & Monitoring

### Administration

Management > Administration

You may want to change your login credentials for logging into your access point. Resetting the access point to factory default settings will also reset the login credentials back to factory default which can be found on the label or on the back of the unit.



1. Log into your management page (see "[Access the management page](#)" on page 13).
2. Click on the **Management** tab and click **Administration**.
3. Review the settings and click **Save** to save settings.

Administrator Settings	
Account	admin
Password	..... (Max: 16 characters)
Idle Timeout	3600 (120-3600 seconds)
<input type="button" value="Save"/> <input type="button" value="Cancel"/>	

- **Account:** Change the login user name in this field
- **Password:** Change the login password in this field

- **Idle Timeout:** Change the length of time that the access point can idle before timing out. The duration can be between 120 – 3600 seconds. (By default it is set to 120 seconds)

### Device Name

Management > Administration

1. Log into your management page (see "[Access the management page](#)" on page 13).
2. Click on the **Management** tab and click **Administration**.
3. In the **Device Name** field, change the name of the device (eg: room, office etc)

Device Name Settings	
Device Name	TEW-821DAP
<input type="button" value="Save"/> <input type="button" value="Cancel"/>	

4. Click on **Save** button to apply the settings and then click on the **Apply/Discard** button located on the top left section to save the settings.

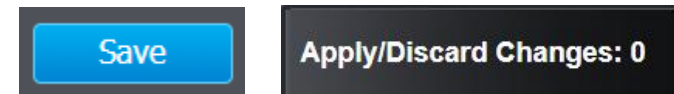

### Reset to factory defaults

Management > Backup/Restore Settings

You may want to reset the access point to factory defaults if you are encountering difficulties and have attempted all other troubleshooting. Before you reset to defaults, if possible, you should backup your access point's configuration first.

There are two methods that can be used to reset your access point to factory defaults.

- **Reset Button:** Located on the side of the access point, (see "[Product Hardware Features](#)" on page 5). Use this method if you are encountering difficulties with accessing your router management page.

OR

- **Access Point Management Page**

1. Log into your management page (see "[Access the management page](#)" on page 13).
2. Click on the **Management** tab and click **Backup/Restore Settings**.
3. Click **Load Default**. If prompted, click **Yes** or **Ok**.

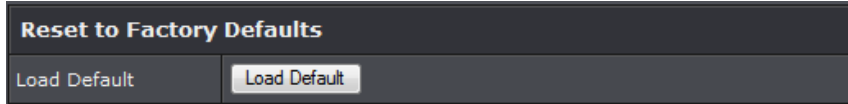

## Backup and restore your configuration settings

*Management > Backup/Restore Settings*

You may have added many customized settings to your router and in the case that you need to reset your router to default, all your customized settings would be lost and would require you to manually reconfigure all of your router settings instead of simply restoring from a backed up router configuration file.

### To back up your configuration:

1. Log into your management page (see "[Access the management page](#)" on page 13).
2. Click on the **Management** tab and click **Backup/Restore Settings**.
3. Click **Export**.

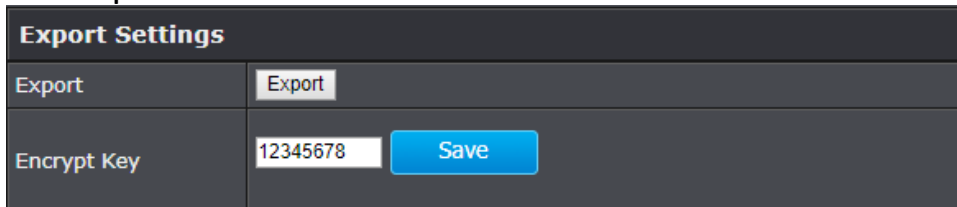

4. When setting and saving an **Encrypt Key**, make sure that the same field is matched when importing the configuration settings. Make sure to click on the **Save** button to apply the settings and then click on the **Apply/Discard** button located on the top left section to save the settings before **Exporting** a configuration file.

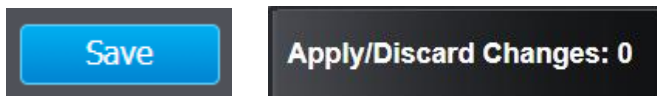

5. Depending on your web browser settings, you may be prompted to save a file (specify the location) or the file may be downloaded automatically to the web browser settings default download folder. (Default Filename: *config.bin*)
6. Save the configuration file to location on your computer.

### To restore your configuration:

1. Log into your management page (see "[Access the management page](#)" on page 13).
2. Click on the **Management** tab and click **Backup/Restore Settings**.
3. Under **Import Settings**, depending on your web browser, click on **Browse** or **Choose File**. A separate file navigation window should open.

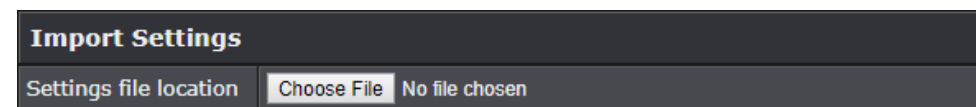

4. Navigate to the location of the access point configuration file to restore. (Default Filename: *config.bin*).
5. Select the access point configuration file to restore. Enter the login password under **Encrypt Key** and click **Save**. (Default Filename: *config.bin*). If prompted, click **Yes** or **OK**.
6. Wait for the access point to restore settings.

## Restart (Reboot) access point

*Management > Backup/Restore Settings*

You may want to restart your access point if you are encountering difficulties with your access point and have attempted all other troubleshooting.

There are two methods that can be used to restart your access point.

- **Turn the router off** disconnect the power source or press the power button from the side of your access point (see "[Product Hardware Features](#)" on page 5).
  - Use this method if you are encountering difficulties with accessing your router management page. This is also known as a hard reboot or power cycle.
- OR
- **Router Management Page:** This is also known as a soft reboot or restart.

1. Log into your management page (see "[Access the management page](#)" on page 13).
2. Click on the **Management** tab and click **Backup/Restore Settings**.



3. Click **Reboot** under **System Reboot** to restart the access point. If prompted, click **yes** or **OK**.

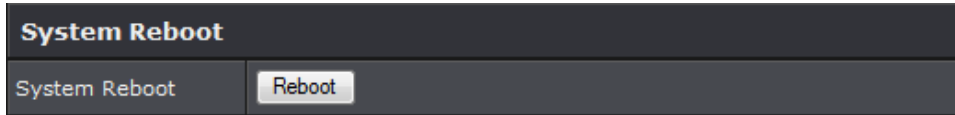

## Upgrade your firmware

*Management > Upload Firmware*

TRENDnet may periodically release firmware upgrades that may add features or fix problems associated with your TRENDnet access point model and version. To check if there is a firmware upgrade available for your device, please check your TRENDnet model and version using the link. <http://www.trendnet.com/downloads/>

In addition, it is also important to verify if the latest firmware version is newer than the one your access point is currently running. To identify the firmware that is currently loaded on your access point, log in to the router, click on the **Status** tab and select **Main**. If there is a newer version available, also review the release notes to check if there were any new features you may want or if any problems were fixed that you may have been experiencing.

1. If a firmware upgrade is available, download the firmware to your computer.
2. Unzip the file to a folder on your computer.

### Please note the following:

- Do not interrupt the firmware upgrade process. Do not turn off the device or press the Reset button during the upgrade.
- If you are upgrade the firmware using a laptop computer, ensure that the laptop is connected to a power source or ensure that the battery is fully charged.
- Disable sleep mode on your computer as this may interrupt the firmware upgrade process.
- Do not upgrade the firmware using a wireless connection, only using a wired network connection.
- Any interruptions during the firmware upgrade process may permanently damage your router.

1. Log into your management page (see "[Access the management page](#)" on page 13).
2. Click on **Management**, and click on **Upload Firmware**.

3. Depending on your web browser, next to **Upgrade Firmware**, click **Browse** or **Choose File**.

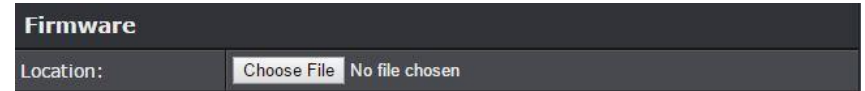

4. Navigate to the folder on your computer where the unzipped firmware file (.bin) is located and select it.
5. Click **Open** to start the firmware upgrade process. If prompted, click **yes** or **OK**.

## Configure log

*Management > Log*

1. Log into your management page (see "[Access the management page](#)" on page 13).
2. Click on the **Management** tab and click **Log**. Click apply to save settings

System Log	
Enable System Log	<input checked="" type="checkbox"/>
Syslog Server IP Address	<input type="text" value="0.0.0.0"/>
Local Log	
Local Log	<input type="text" value="Enable"/>

- **Enable System log:** Select option to enable system log feature
- **Syslog Server IP Address:** Enter the IP address of the syslog server
- **Local Log:** Select enable to enable local log feature

3. Click on **Save** button to apply the settings and then click on the **Apply/Discard Changes** button located on the top left section to save the settings.

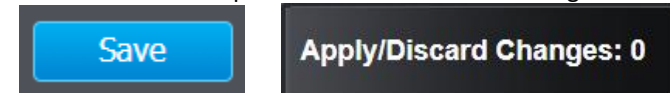

## Diagnostics

*Management > Diagnostics*

### Ping Test

1. Log into your management page (see "[Access the management page](#)" on page 13).
2. Click on the **Management** tab and click **Diagnostics**.

Ping Test Parameter	
IP	<input type="text"/>
Packet Length	64 <input type="text"/> (bytes)
Number of Pings	4 <input type="text"/>

- **IP:** Enter the IP address you would like to conduct the ping test
- **Packet Length:** Enter the packet size
- **Number of Pings:** Enter the amount of pings to conduct.
- **Ping:** Click to start ping test

### TraceRoute

1. Log into your management page (see "[Access the management page](#)" on page 13).
2. Click on the **Management** tab and click **Diagnostic**.

Traceroute Parameter	
Target	<input type="text"/>

- **Target:** Enter the IP address to conduct traceroute test
- **Traceroute:** Click to start traceroute test

### Download Technical Support Data

1. Log into your management page (see "[Access the management page](#)" on page 13).
2. Click on the **Management** tab and click **Diagnostic**.

Download Technical Support Data	
Download Data	<input type="button" value="Download"/>

3. Depending on your web browser settings, you may be prompted to save a file (specify the location) or the file may be downloaded automatically to the web browser settings default download folder. (Default Filename: *TRENDnet EAP\_config.bin*)
4. Save the configuration file to location on your computer.

**\*\*Technical Data may be requested from you by a technical support representative to further assist you with issues\*\***

## Check system information

*Status > Main*

1. Log into your management page (see "[Access the management page](#)" on page 16).
2. Click on the **Status** tab and click **Main**.
3. Review the device information.

### System

System Info	
Device Name	TEW-821DAP
Firmware Version	2.00 , 7, May, 2018
System Time	Sun May, 6, 2018 23:17:38
System Up Time	0 Day, 1:43:17

- **Device Name:** Displays the assigned device name
- **Firmware Version:** Displays the firmware version currently loaded on the router
- **System Time:** Displays the current time of the device
- **System Up Time:** Displays the time duration of how long the device has been running

### Network

Network	
MAC Address	D8:FE:E3:3E:B3:AB
IP Address	192.168.20.109
Subnet Mask	255.255.255.0
Default Gateway	192.168.20.1
Primary Domain Name Server	192.168.20.1
Secondary Domain Name Server	0.0.0.0

- **MAC Address:** Displays the device's MAC address
- **IP Address:** Displays the assigned IP address
- **Subnet Mask:** Displays the subnet mask of the device
- **Default Gateway:** Displays the default gateway of the device
- **Primary/Secondary DNS:** Displays the DNS IP address of the device

**Wireless (Both 2.4GHz and 5 GHz)**

2.4GHz Wireless			
Operation Mode	Access Point		
Wireless Mode	2.4GHz 802.11 b/g/n mixed mode		
Channel Width	Auto 20/40 MHz		
Frequency (Channel)	6		
TX(Packets)	44.8 KB (314 PKts.)		
RX(Packets)	50.0 KB (276 PKts.)		
SSID List:			
SSID	MAC Address	Security Mode	Status
TRENDnet825_2.4GHz_821D	00:18:E7:95:82:1D	WPA2-PSK AES	On

- **Operation Mode:** Displays the current operating mode for each wireless band
- **Wireless Mode:** Displays the wireless mode set on each wireless band
- **Channel Width:** Displays the applied channel width
- **Frequency (Channel):** Displays the current operating wireless channel
- **Tx/Rx Packets:** Displays the Transmit (Tx) and Receive (Rx) packet rate
- **SSID List:** Displays the multiple SSID settings.

**Check connected wireless clients**

Status > 2.4GHz/5GHz Wireless Client

1. Log into your management page (see "[Access the management page](#)" on page 16).
2. Click on the **Status** tab and click **2.4G** or **5G** Wireless Client List.

**Wireless Network**

SSID: #	MAC Address	Mode	Rate	Signal	TX(Bytes)	RX(Bytes)	Kick and Ban
---------	-------------	------	------	--------	-----------	-----------	--------------

- **SSID:** Displays the SSID that the client is connected to
- **MAC Address:** Displays the MAC address of the client that is connected to the access point
- **Mode:** Displays the 802.11 wireless mode and the channel width that the client device is connected.
- **Rate:** Displays the signal rate the client device is connected.
- **Signal:** Displays the signal strength in percentage. The higher the number, the higher the signal strength.

- **TX(Bytes):** Displays the amount of data transmitted to the client
- **RX(Bytes):** Displays the amount of data received from the client
- **Kick and Ban:** Clicking this option will allow you to kick the client from the network and ban them as well

**System Log**

Status > System Log

System log keeps track of changes made to the access point.

1. Log into your management page (see "[Access the management page](#)" on page 13).
2. Click on the **Status** tab and click **System Log**.

System Log	
Mar 21 01:20:04	TEW-825DAP [ 23.260000] ADDRCONF(NETDEV_UP): lo: link is not ready
Mar 21 01:20:04	TEW-825DAP [ 23.380000] ADDRCONF(NETDEV_UP): eth0: link is not ready
Mar 21 01:20:04	TEW-825DAP [ 23.390000] ADDRCONF(NETDEV_UP): eth0: link is not ready
Mar 21 01:20:04	TEW-825DAP [ 23.390000] device eth0 entered promiscuous mode
Mar 21 01:20:04	TEW-825DAP Interface 'lan' is enabled
Mar 21 01:20:04	TEW-825DAP Interface 'lan2' is enabled
Mar 21 01:20:04	TEW-825DAP [ 23.400000] ADDRCONF(NETDEV_UP): br-lan: link is not ready
Mar 21 01:20:04	TEW-825DAP Interface 'lan' is setting up now
Mar 21 01:20:04	TEW-825DAP Interface 'lan2' is setting up now
Mar 21 01:20:04	TEW-825DAP Interface 'lan2' is now up
Mar 21 01:20:04	TEW-825DAP Interface 'loopback' is enabled
Mar 21 01:20:04	TEW-825DAP Interface 'loopback' is setting up now
Mar 21 01:20:04	TEW-825DAP Network device 'lo' link is up
Mar 21 01:20:04	TEW-825DAP Interface 'loopback' has link connectivity

Refresh Clear

- **Refresh:** Clicking **Refresh** allows the access point to update the log with any new data that has not been previously logged yet.
- **Clear:** Clears all the data saved previously onto the log.

**IPv6 Status**

Status > IPv6 Status

1. Log into your management page (see "[Access the management page](#)" on page 13).
2. Click on the **Status** tab and click **IPv6 Status**.

Network	
IPv6 Connection Type	Local Connectivity Only
LAN IPv6 Link-Local Address	fe80::dafe:e3ff:fe3e:b3ab/64

## AP utility Installation

1. Download the latest version of the utility by navigating to <http://www.trendnet.com/support> and selecting model TEW-821DAP within the Product Download drop-down list.
2. Extract the contents of the .zip file and run the .exe installer to install the utility.
3. Once the utility is installed click on Discover to refresh the list of access points.

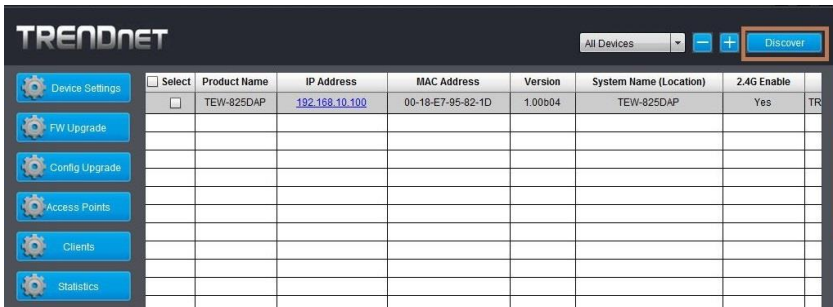

4. Select the access point you want to configure.



5. Click on Device settings to configure the access point.

## Device Settings

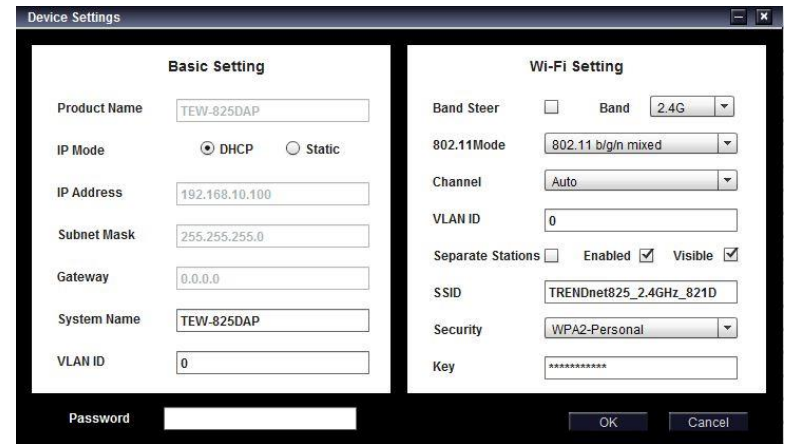

- **Product Name:** Displays the device model
- **IP Mode:** Select the IP mode to apply on the device
  - **DHCP:** Select this option to allow the device to receive IP address from your DHCP server
  - **Static:** Select this option to manually set the IP address of the device
- **IP Address:** Enter the IP address to assign to the device
- **Subnet Mask:** Enter the subnet mask to assign to the device
- **Gateway:** Enter the gateway IP address to assign to the device
- **System Name:** Assign name of the device to help distinguish between similar devices
- **VLAN ID:** Assigns the VLAN ID for the Ethernet port.
- **Band Steer:** Select this to enable/disable band steering
- **Band:** Select on the pull-down menu the wireless interface to configure
- **802.11 Mode:** Select the 802.11 mode of the selected wireless interface
- **Channel:** Select the wireless channel of the selected wireless interface
- **VLAN ID:** Assigns the VLAN ID for the primary SSID.
- interface

- **Separate Stations:** Select this option to restrict wireless client devices from accessing other client devices connected to this network(s).
- **Enable:** Select this option to enable the selected wireless interface
- **Visible:** Select this option to wireless broadcast the selected wireless interface
- **SSID:** Enter the SSID (Wireless Network Name) of the selected wireless interface
- **Security:** Select the wireless encryption security for to assign the selected wireless interface
- **Key:** Enter the wireless encryption security key or password
- **Password:** Enter the login password of the device and click OK to save settings

### Add and Delete Device

#### Add device

1. Run the utility
2. To add a device to control select the "+" on the upper right corner.



3. Enter the IP address of the device you would like to add to the controller and press OK.



#### Delete device

1. Run the utility

2. To delete a device from the controller. Select the device from the listed devices and click "-" on the upper right corner.



3. Confirm the deletion of the device by pushing **Ok**.



### Upgrade Firmware

1. Run the utility
2. Select the devices you want to conduct a firmware upgrade and click on FW upgrade button

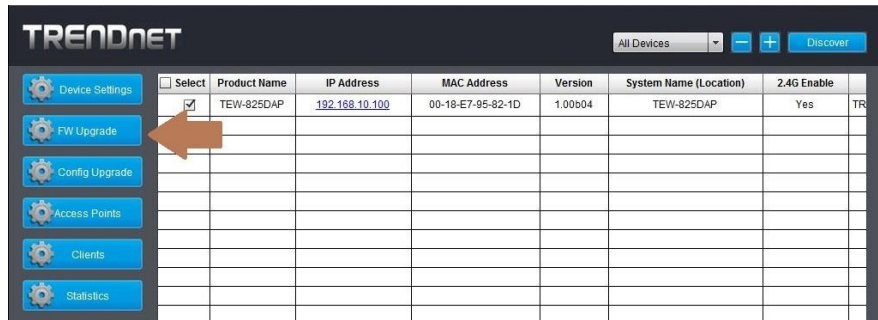

2. Click Browse button and navigate to the folder on your computer where the unzipped firmware file (.bin) is located and select it to select the firmware

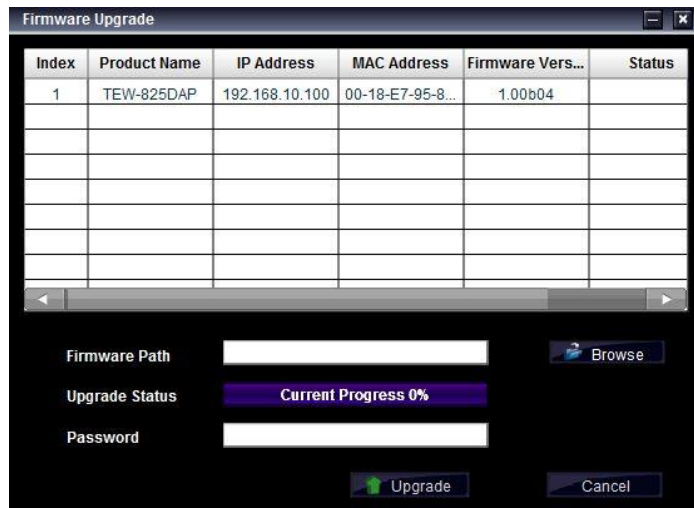

3. Enter the login password of the devices and click **Upgrade** to start the firmware upgrade process.

### Load configuration

1. Run the utility

2. Select the devices you want to conduct a configuration upgrade and click **Config Upgrade** button

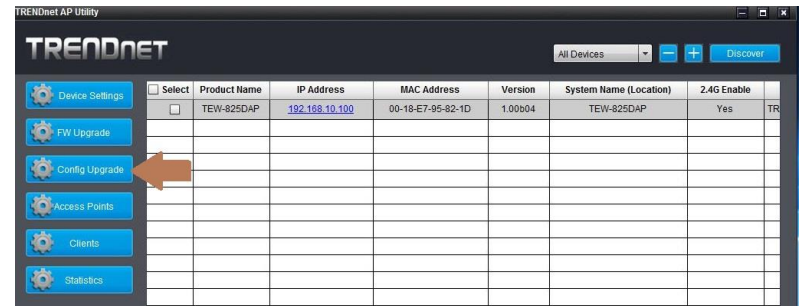

2. Click Browse button and navigate to the folder on your computer where the unzipped firmware file (.bin) is located and select it to select the firmware

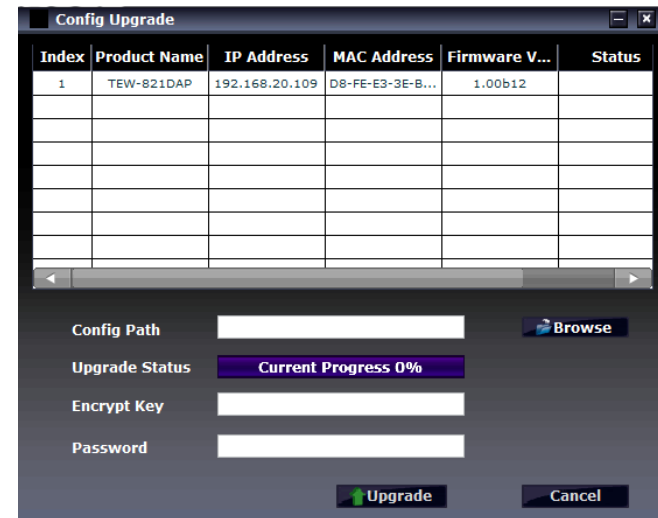

3. Enter the login password of the devices and click **Upgrade** to start the firmware upgrade process.

### Access Points

1. To view access points that are currently connected to your network, click on the **Access Points** tab.

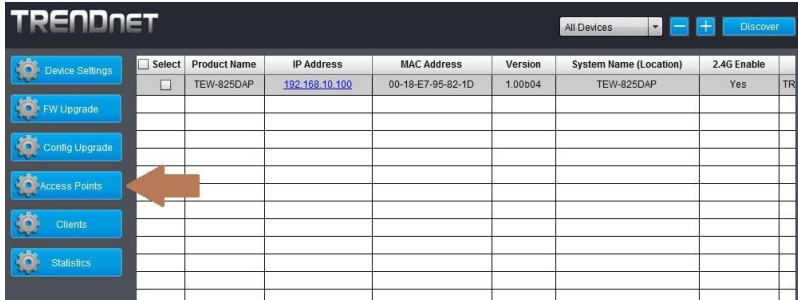

2. Review the AP setting information below.

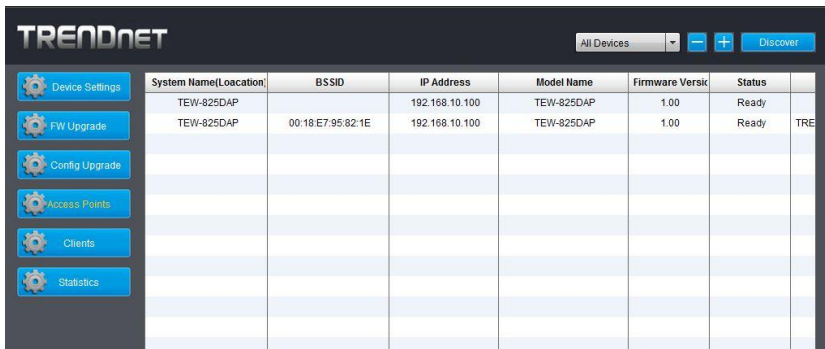

**System Name:** Displays the name of the device. This can be changed in the AP utility under **Device Setting** (see page 39)

**BSSID:** Displays the wireless MAC address of the access points on the network

**IP Address:** Displays the IP address of the access points on the network

**Model Name:** Displays the model number of the access points connected on the network

**Firmware Version:** Displays the current firmware version of the access points connected on the network

**Status:** Displays the current status of the access points connected on the network

**SSID:** Displays the SSID (Wireless Network Name) of the access points connected on the network

**Channel:** Displays the current channel that the access point is on

**Total Clients:** Displays the number of clients (devices) that is currently connected to the access point

**Upload/Download:** Displays the amount of data that the access point has sent and received

### Clients

1. To view devices that are currently connected to your network, click on the **Clients** tab.

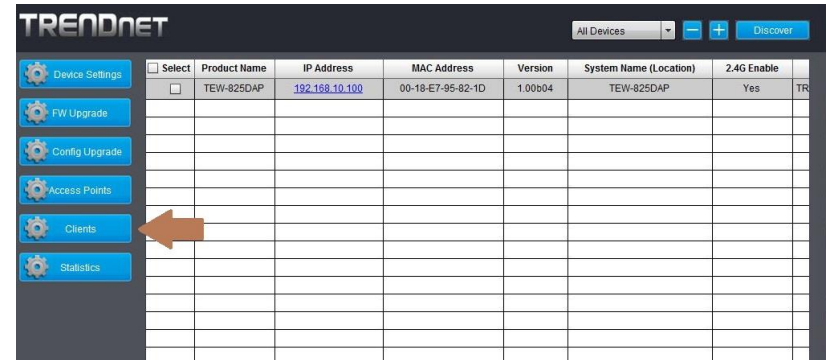

2. Review the client setting information below.

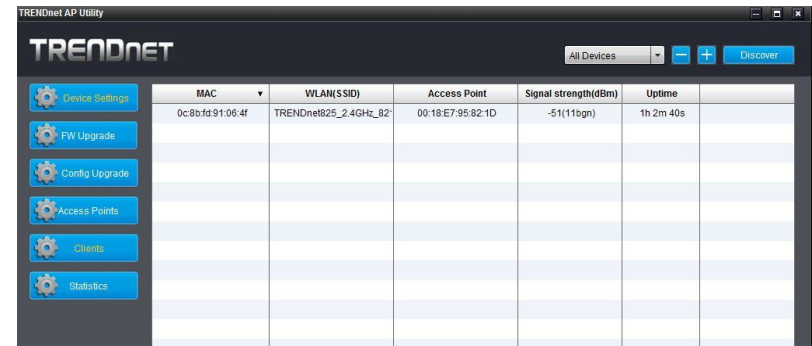

**MAC:** Displays the MAC address that is connected to the access point

**WLAN (SSID):** Displays the SSID (wireless network name) of the access point the device is connected to

**Access Point:** Displays the wireless MAC address of the access points on the network that the device is connected to

**Signal strength (dBm):** Displays the signal strength between the access point and the client. ie: -40 is a stronger signal than -50.

**Uptime:** Displays the duration the client has been connected to the access point

## Statistics

1. To view statistical data about your access point, click on the **Statistics** tab.

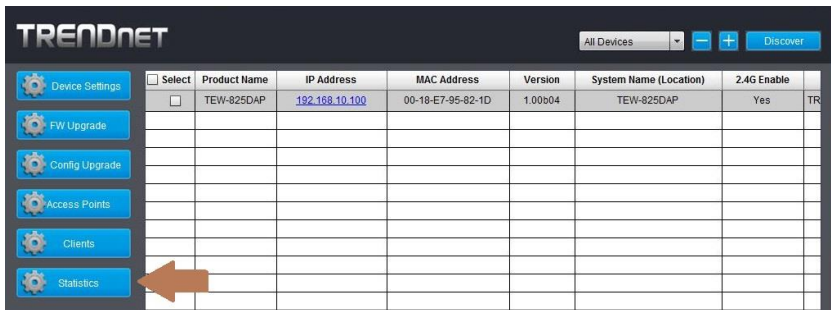

2. Review the statistics information below.

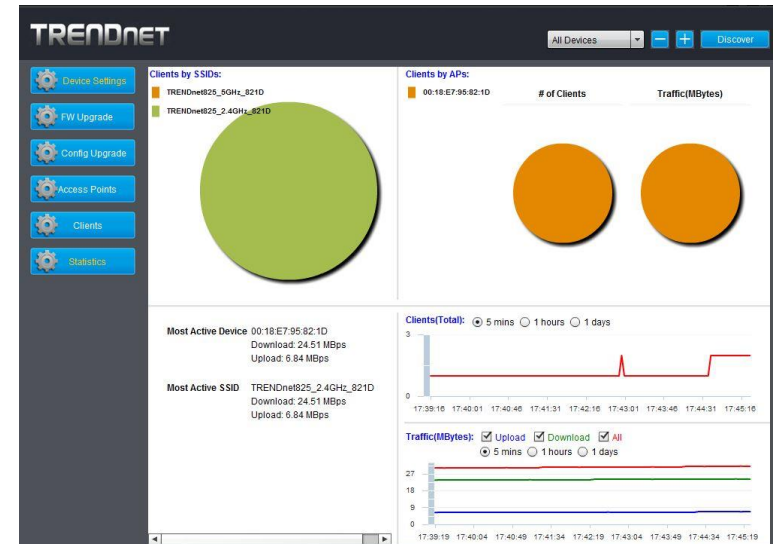

- **Clients by SSIDs:** Displays the number of clients connected to the access point in comparison between the different SSIDs (wireless network name). Mouse over the chart to view a current break-down of the total number of clients connected to the selected SSID.
- **Clients by AP:** Displays number of clients and traffic per access point.
- **Most Active Device:** Displays the access point with the most activity in comparison between other access points on the network.
- **Most Active SSID:** Displays the SSID (wireless network name) with the most amount of activity.
- **Clients (Total):** Shows the number of clients currently connected onto the access point. The unit of measurement (time) can be configured to show the number of devices connected in the last 5 minutes, hours, or days
- **Traffic (MBytes):** This displays the amount of throughput (upload, download, all) that has been passed. This can be configured to display only upload, download, or all.





## Technical Specifications

### Standards

- IEEE 802.3
- IEEE 802.3u
- IEEE 802.3x
- IEEE 802.3ab
- IEEE 802.3af
- IEEE 802.1Q
- IEEE 802.11a
- IEEE 802.11b
- IEEE 802.11g
- IEEE 802.11n (up to 300 Mbps)
- IEEE 802.11ac Wave 2 (up to 867 Mbps)

### Hardware Interface

- 1 x PoE Gigabit LAN port
- Power port (optional non-PoE installation)
- LED indicators
- Mounting plate and cable guard
- On/Off power button
- Reset button

### Features

- 802.11ac MU-MIMO Wave 2 support
- IP30 rated housing (with mounting plate and cable guard installed)
- Concurrent dual band
- Band steering
- WiFi traffic shaping
- 802.1Q VLAN assignment per SSID
- IPv6 support (Link-Local, Static IPv6, Auto-Configuration (SLAAC/DHCPv6))
- Multi-Language interface, English, French, Spanish, German, Russian
- LEDs on/off

- Captive Portal (external Coovachilli server authentication)
- Internal Captive Portal (Local user account authentication and customizable portal page)
- 802.11k intelligent radio resource management
- RSSI Threshold (client signal strength and connectivity control)
- Airtime Fairness

### Operation Modes

- Access Point
- Client Bridge
- WDS AP
- WDS Bridge
- WDS Station
- Repeater

### Management/Monitoring

- Web based management
- AP software utility
- SNMP v1/v3
- STP
- Event logging
- Ping test
- Traceroute
- CLI

### Access Control

- Wireless encryption: WEP, WPA/WPA2-PSK, WPA/WPA2-RADIUS
- MAC filter
- Maximum client limit

### QoS

- WMM
- Bandwidth control per SSID or client

**SSID**

- Up to 8 SSIDs per wireless band (16 total)

**Frequency**

- 2.4GHz: 2.412 – 2.472GHz
- 5GHz: 5.180 – 5.8525GHz

**Wireless Channels**

- 2.4GHz: FCC: 1–11, ETSI: 1 – 13
- 5GHz: FCC: 36, 40, 44, 48, 149, 153, 157, 161 and 165 ETSI: 36, 40, 44, 48 (52, 56, 60, 64, 100,104,108,112,116, 132,136,140)\*\*

**Modulation**

- DBPSK/DQPSK/CCK for DSSS technique
- BPSK/QPSK/16-QAM/64-QAM/256-QAM for OFDM technique

**Antenna Gain**

- 2.4GHz: 2 x 3 dBi internal
- 5GHz: 2 x 4 dBi internal

**Wireless Output Power**

- 802.11a: FCC: 19 dBm (max.) / CE: 19 dBm (max.) / IC: 19 dBm (max.)
- 802.11b: FCC: 23 dBm (max.) / CE: 10 dBm (max.) / IC: 23 dBm (max.)
- 802.11g: FCC: 19 dBm (max.) / CE: 12 dBm (max.) / IC: 19 dBm (max.)
- 802.11n (2.4 GHz): FCC: 19 dBm (max.) / CE: 12 dBm (max.) / IC: 19 dBm (max.)
- 802.11n (5 GHz): FCC: 19 dBm (max.) / CE: 19 dBm (max.) / IC: 19 dBm (max.)
- 802.11ac: FCC: 18 dBm (max.) / CE: 18 dBm (max.) / IC: 18 dBm (max.)

**Receiving Sensitivity**

- 802.11a: -65 dBm (typical) @ 54 Mbps
- 802.11b: -83 dBm (typical) @ 11 Mbps
- 802.11g: -65 dBm (typical) @ 54 Mbps
- 802.11n (2.4 GHz): -64 dBm (typical) @ 300 Mbps
- 802.11n (5 GHz): -61 dBm (typical) @ 300 Mbps
- 802.11ac: -51 dBm (typical) @ 867 Mbps

**Power**

- IEEE 802.3af Type 1 PoE PD Class 3
- Input: 100 - 240V AC, 50/60Hz, Output: 12V DC, 1A external power adapter (optional)
- Max. consumption: 8W

**Operating Temperature**

- 0° – 40° C (32° – 104° F)

**Operating Humidity**

- Max. 95% non-condensing

**Certifications**

- CE
- FCC
- IC

**Dimensions**

- 163 x 165 x 44mm (6.4 x 6.5 x 1.7 in.)

**Weight**

- 372g (13.1 oz.)

**Warranty:**

- 3 year limited

**Package Contents**

- TEW-821DAP
- Network cable (1.5m/5 ft.)
- Quick Installation Guide
- Power adapter (12V DC, 1A)
- Mounting plate and cable guard

**Disclaimer**

\*Maximum wireless signal rates are referenced from IEEE 802.11 theoretical specifications. Actual data throughput and coverage will vary depending on interference, network traffic, building materials and other conditions. For maximum performance of up to 867Mbps use with an 867Mbps 802.11ac wireless adapter. For maximum performance of up to 300Mbps, use with a 300Mbps 802.11n wireless adapter. Multi-User MIMO (MU-MIMO) requires the use of multiple MU-MIMO enabled wireless adapters.

\*\*Due to regulatory requirements, the wireless channels specified cannot be statically assigned, but will be available within the available wireless channels when set to auto.

## Troubleshooting

**Q: I typed `http://192.168.10.1` in my Internet Browser Address Bar, but an error message says "The page cannot be displayed." How can I access the access point management page?**

**Answer:**

1. Check your hardware settings again. See "[Getting Started](#)" on page 7.
2. Make sure the LAN and WLAN lights are lit.
3. Make sure your network adapter TCP/IP settings are set to *Obtain an IP address automatically* or *DHCP* (see the steps below).
4. Make sure your computer is connected to one of the router's LAN ports
5. Press on the factory reset button for 15 seconds, the release.

**Windows 10/8.1/8/7**

- a. Go into the **Control Panel**, click **Network and Sharing Center**.
- b. Click **Change Adapter Settings**, right-click the **Local Area Connection** icon.
- c. Then click **Properties** and click **Internet Protocol Version 4 (TCP/IPv4)**.
- d. Then click **Obtain an IP address automatically** and click **OK**.

**Windows Vista**

- a. Go into the **Control Panel**, click **Network and Internet**.
- b. Click **Manage Network Connections**, right-click the **Local Area Connection** icon and click **Properties**.
- c. Click **Internet Protocol Version (TCP/IPv4)** and then click **Properties**.
- d. Then click **Obtain an IP address automatically** and click **OK**.

**Windows XP/2000**

- a. Go into the **Control Panel**, double-click the **Network Connections** icon
- b. Right-click the **Local Area Connection** icon and the click **Properties**.
- c. Click **Internet Protocol (TCP/IP)** and click **Properties**.
- d. Then click **Obtain an IP address automatically** and click **OK**.

**Note:** *If you are experiencing difficulties, please contact your computer or operating system manufacturer for assistance.*

**Q: I am not sure what type of Internet Account Type I have for my Cable/DSL connection. How do I find out?**

**Answer:**

Contact your Internet Service Provider (ISP) for the correct information.

**Q: The Wizard does not appear when I access the access point. What should I do?**

**Answer:**

1. Click on Wizard on the left-hand side.
2. Near the top of the browser, "Pop-up blocked" message may appear. Right click on the message and select Always Allow Pop-ups from This Site.
3. Disable your browser's pop up blocker.

**Q: I went through the Wizard, but I cannot get onto the Internet. What should I do?**

**Answer:**

1. Verify that you can get onto the Internet with a direct connection into your modem (meaning plug your computer directly to the modem and verify that your single computer (without the help of the router) can access the Internet).
2. Power cycle your modem and router. Unplug the power to the modem and router. Wait 30 seconds, and then reconnect the power to the modem. Wait for the modem to fully boot up, and then reconnect the power to the router.
3. Contact your ISP and verify all the information that you have in regards to your Internet connection settings is correct.

**Q: I cannot connect wirelessly to the access point. What should I do?**

**Answer:**

1. Double check that the LAN light on the access point is lit.
2. Power cycle the router. Unplug the power to the router. Wait 15 seconds, then plug the power back in to the router.
3. Contact the manufacturer of your wireless network adapter and make sure the wireless network adapter is configured with the proper SSID. The preset SSID is TRENDnet (*model\_number*).
4. To verify whether or not wireless is enabled, login to the router management page, click on *Wireless*.
5. Please see "[Steps to improve wireless connectivity](#)" on page 8 if you continue to have wireless connectivity problems.

## Appendix

### How to find your IP address?

**Note:** Please note that although the following procedures provided to follow for your operating system on configuring your network settings can be used as general guidelines, however, it is strongly recommended that you consult your computer or operating system manufacturer directly for assistance on the proper procedure for configuring network settings.

#### Command Prompt Method

##### **Windows 2000/XP/Vista/7/8/8.1/10**

1. On your keyboard, press **Windows Logo + R** keys simultaneously to bring up the Run dialog box.
2. In the dialog box, type **cmd** to bring up the command prompt.
3. In the command prompt, type **ipconfig /all** to display your IP address settings.

##### **MAC OS X**

1. Navigate to your **Applications** folder and open **Utilities**.
2. Double-click on **Terminal** to launch the command prompt.
3. In the command prompt, type **ipconfig getifaddr <en0 or en1>** to display the wired or wireless IP address settings.

**Note:** **en0** is typically the wired Ethernet and **en1** is typically the wireless Airport interface.

#### Graphical Method

##### **MAC OS 10.6 – 10.12**

1. From the Apple menu, select **System Preferences**.
2. In System Preferences, from the **View** menu, select **Network**.
3. In the Network preference window, click a network port (e.g., Ethernet, AirPort, modem). If you are connected, you'll see your IP address settings under "Status:"

##### **MAC OS 10.4**

1. From the Apple menu, select **Location**, and then **Network Preferences**.
2. In the Network Preference window, next to "Show:", select **Network Status**. You'll see your network status and your IP address settings displayed.

**Note:** If you are experiencing difficulties, please contact your computer or operating system manufacturer for assistance.

### How to configure your network settings to obtain an IP address automatically or use DHCP?

**Note:** Please note that although the following procedures provided to follow for your operating system on configuring your network settings can be used as general guidelines, however, it is strongly recommended that you consult your computer or operating system manufacturer directly for assistance on the proper procedure for configuring network settings.

#### **Windows 7 and up**

- a. Go into the **Control Panel**, click **Network and Sharing Center**.
- b. Click **Change Adapter Settings**, right-click the **Local Area Connection** icon.
- c. Then click **Properties** and click **Internet Protocol Version 4 (TCP/IPv4)**.
- d. Then click **Obtain an IP address automatically** and click **OK**.

#### **Windows Vista**

- a. Go into the **Control Panel**, click **Network and Internet**.
- b. Click **Manage Network Connections**, right-click the **Local Area Connection** icon and click **Properties**.
- c. Click **Internet Protocol Version (TCP/IPv4)** and then click **Properties**.
- d. Then click **Obtain an IP address automatically** and click **OK**.

#### **Windows XP/2000**

- a. Go into the **Control Panel**, double-click the **Network Connections** icon
- b. Right-click the **Local Area Connection** icon and the click **Properties**.
- c. Click **Internet Protocol (TCP/IP)** and click **Properties**.
- d. Then click **Obtain an IP address automatically** and click **OK**.

#### **MAC OS 10.4/10.5/10.6**

- a. From the **Apple**, drop-down list, select **System Preferences**.
- b. Click the **Network** icon.
- c. From the **Location** drop-down list, select **Automatic**.
- d. Select and view your Ethernet connection.
  - In MAC OS 10.4, from the **Show** drop-down list, select **Built-in Ethernet** and select the **TCP/IP** tab.
  - In MAC OS 10.5/10.6, in the left column, select **Ethernet**.
- e. Configure TCP/IP to use DHCP.

In MAC 10.4, from the **Configure IPv4**, drop-down list, select **Using DHCP** and click the **Apply Now** button.

In MAC 10.5, from the **Configure** drop-down list, select **Using DHCP** and click the **Save** button.

In MAC 10.6, from the **Configure** drop-down list, select **Using DHCP** and click the **Save** button.

f. Restart your computer.

**Note:** If you are experiencing difficulties, please contact your computer or operating system manufacturer for assistance.

### How to find your MAC address?

In Windows 2000/XP/Vista/7/8/8.1/10,

Your computer MAC addresses are also displayed in this window, however, you can type **getmac -v** to display the MAC addresses only.

In MAC OS 10.4,

1. **Apple Menu > System Preferences > Network**
2. From the **Show** menu, select **Built-in Ethernet**.
3. On the **Ethernet** tab, the **Ethernet ID** is your MAC Address.



In MAC OS 10.5/10.6,

1. **Apple Menu > System Preferences > Network**
2. Select **Ethernet** from the list on the left.
3. Click the **Advanced** button.
3. On the **Ethernet** tab, the **Ethernet ID** is your MAC Address.

### How to connect to a wireless network using the built-in Windows utility?

**Note:** Please note that although the following procedures provided to follow for your operating system on configuring your network settings can be used as general guidelines, however, it is strongly recommended that you consult your computer or operating system manufacturer directly for assistance on the proper procedure for connecting to a wireless network using the built-in utility.

#### Windows 7/8/8.1/10

1. Open Connect to a Network by clicking the network icon ( or ) in the notification area.
2. In the list of available wireless networks, click the wireless network you would like to connect to, then click **Connect**.
4. You may be prompted to enter a security key in order to connect to the network.
5. Enter in the security key corresponding to the wireless network, and click **OK**.

#### Windows Vista

1. Open Connect to a Network by clicking the **Start Button**  and then click **Connect To**.
2. In the **Show** list, click **Wireless**.
3. In the list of available wireless networks, click the wireless network you would like to connect to, then click **Connect**.
4. You may be prompted to enter a security key in order to connect to the network.
5. Enter in the security key corresponding to the wireless network, and click **OK**.

#### Windows XP

1. Right-click the network icon in the notification area, then click **View Available Wireless Networks**.
2. In **Connect to a Network**, under **Available Networks**, click the wireless network you would like to connect to.
3. You may be prompted to enter a security key in order to connect to the network.
4. Enter in the security key corresponding to the wireless network, and click **Connect**.

### Federal Communication Commission Interference Statement

This equipment has been tested and found to comply with the limits for a Class B digital device, pursuant to Part 15 of the FCC Rules. These limits are designed to provide reasonable protection against harmful interference in a residential installation. This equipment generates, uses and can radiate radio frequency energy and, if not installed and used in accordance with the instructions, may cause harmful interference to radio communications. However, there is no guarantee that interference will not occur in a particular installation. If this equipment does cause harmful interference to radio or television reception, which can be determined by turning the equipment off and on, the user is encouraged to try to correct the interference by one of the following measures:



- Reorient or relocate the receiving antenna.
- Increase the separation between the equipment and receiver.
- Connect the equipment into an outlet on a circuit different from that to which the receiver is connected.
- Consult the dealer or an experienced radio/TV technician for help.

FCC Caution: Any changes or modifications not expressly approved by the party responsible for compliance could void the user's authority to operate this equipment.

This device complies with Part 15 of the FCC Rules. Operation is subject to the following two conditions: (1) This device may not cause harmful interference, and (2) this device must accept any interference received, including interference that may cause undesired operation.

#### IMPORTANT NOTE:

##### Radiation Exposure Statement:

This equipment complies with FCC radiation exposure limits set forth for an uncontrolled environment. This equipment should be installed and operated with minimum distance 20cm between the radiator & your body.

This transmitter must not be co-located or operating in conjunction with any other antenna or transmitter.

Country Code selection feature to be disabled for products marketed to the US/CANADA

### Europe – EU Declaration of Conformity

TRENDnet hereby declare that the product is in compliance with the essential requirements and other relevant provisions under our sole responsibility.

#### Safety

EN60950-1: 2006 + A11: 2009 + A1: 2010 + A12: 2011 + A2: 2013

#### EMC

EN 301 489-1 V1.9.2: 09-2011  
 EN 301 489-17 V2.2.1: 09-2012  
 EN 55032: 2012 + AC: 2013  
 EN 55024: 2010



#### Radio Spectrum & Health

EN 300 328 V1.9.1: 02-2015  
 EN 301 893 V1.8.1: 03-2015  
 EN 62311: 2008

#### Energy Efficiency

Regulation (EC) No. 1275/2008, Regulation, No. 278/2009, No. 801/2013

This product is herewith confirmed to comply with the Directives.

#### Directives

Low Voltage Directive 2014/35/EU  
 EMC Directive 2014/30/EC  
 R&TTE Directive 1999/5/EC  
 EMF Directive 1999/519/EC  
 Ecodesign Directive 2009/125/EC  
 RoHS Directive 2011/65/EU  
 REACH Regulation (EC) No. 1907/2006

Operations in the 5.15-5.25GHz / 5.470 ~ 5.725GHz band are restricted to indoor usage only.

The band from 5600-5650MHz will be disabled by the software during the manufacturing and cannot be changed by the end user. This device meets all the other requirements specified in Part 15E, Section 15.407 of the FCC Rules.



<b>cs</b> Český [Czech]	TRENDnet tímto prohlašuje, že tento TEW-821DAP je ve shodě se základními požadavky a dalšími příslušnými ustanoveními směrnice 2014/35/EU, 2014/30/EU, 1999/5/ES, 1999/519/ES, 2009/125/ES, a 2011/65/EU.
<b>da</b> Dansk [Danish]	Undertegnede TRENDnet erklærer herved, at følgende udstyr TEW-821DAP overholder de væsentlige krav og øvrige relevante krav i direktiv 2014/35/EU, 2014/30/EU, 1999/5/EF, 1999/519/EF, 2009/125/EF, og 2011/65/EU.
<b>de</b> Deutsch [German]	Hiermit erklärt TRENDnet, dass sich das Gerät TEW-821DAP in Übereinstimmung mit den grundlegenden Anforderungen und den übrigen einschlägigen Bestimmungen der Richtlinie 2014/35/EU, 2014/30/EU, 1999/5/EG, 1999/519/EG, 2009/125/EG, und 2011/65/EU befindet.
<b>et</b> Eesti [Estonian]	Käesolevaga kinnitab TRENDnet seadme TEW-821DAP vastavust direktiivi 2014/35/EU, 2014/30/EU, 1999/5/EÜ, 1999/519/EÜ, 2009/125/EÜ, ja 2011/65/EU põhinõuetele ja nimetatud direktiivist tulenevatele teistele asjakohastele sätetele.
<b>en</b> English	Hereby, TRENDnet, declares that this TEW-821DAP is in compliance with the essential requirements and other relevant provisions of Directive 2014/35/EU, 2014/30/EU, 1999/5/EC, 1999/519/EC, 2009/125/EC, and 2011/65/EU.
<b>es</b> Español [Spanish]	Por medio de la presente TRENDnet declara que el TEW-821DAP cumple con los requisitos esenciales y cualesquiera otras disposiciones aplicables o exigibles de la Directiva 2014/35/EU, 2014/30/CE, 1999/5/CE, 1999/519/CE, 2009/125/CE, 2011/65/EU y.
<b>el</b> Ελληνική [Greek]	ΜΕ ΤΗΝ ΠΑΡΟΥΣΑΤRENDnet ΔΗΛΩΝΕΙ ΟΤΙΤΕΤΕW-821DAPΣΥΜΜΟΡΦΩΝΕΤΑΙ ΠΡΟΣ ΤΙΣ ΟΥΣΙΩΔΕΙΣ ΑΠΑΙΤΗΣΕΙΣ ΚΑΙ ΤΙΣ ΛΟΙΠΕΣ ΣΧΕΤΙΚΕΣ ΔΙΑΤΑΞΕΙΣ ΤΗΣ ΟΔΗΓΙΑΣ 2014/35/EU, 2014/30/EU, 1999/5/EK, 1999/519/EK, 2009/125/EK, 2011/65/EU και.
<b>fr</b> Français [French]	Par la présente TRENDnet déclare que l'appareil TEW-821DAP est conforme aux exigences essentielles et aux autres dispositions pertinentes de la 2014/35/EU, 2014/30/UE, 1999/5/CE, 1999/519/CE, 2009/125/CE, 2011/65/UE et.
<b>it</b> Italiano [Italian]	Con la presente TRENDnet dichiara che questo TEW-821DAP è conforme ai requisiti essenziali ed alle altre disposizioni pertinenti stabilite dalla direttiva 2014/35/UE, 2014/30/UE, 1999/5/CE, 1999/519/CE, 2009/125/CE, e 2011/65/UE.
Latviski [Latvian]	AršoTRENDnetdeklarē, ka TEW-821DAP atbilstDirektīvas 2014/35/EU, 2014/30/EU, 1999/5/EK, 1999/519/EK, 2009/125/EK, un 2011/65/EU būtiskajāmprasībām un citiemar to saistītajiemnoteikumiem.
Lietuvių [Lithuanian]	Šiuo TRENDnet deklaruoja, kad šis TEW-821DAP atitinka esminius reikalavimus ir kitas 2014/35/EU, 2014/30/EU, 1999/5/EB, 1999/519/Eb m 2009/125/EB, ir 2011/65/EU Direktyvos nuostatas.

<b>nl</b> Nederlands [Dutch]	Hierbij verklaart TRENDnet dat het toestel TEW-821DAP in overeenstemming is met de essentiële eisen en de andere relevante bepalingen van richtlijn 2014/35/EU, 2014/30/EU, 1999/5/EG, 1999/519/EG, 2009/125/EG, en 2011/65/EU.
<b>mt</b> Malti [Maltese]	Hawnhekk, TRENDnet, jiddikjara li dan TEW-821DAP jikkonforma mal-htigijiet essenzjali u ma provvedimenti oħrajn relevanti li hemm fid-Dirrettiva 2014/35/EU, 2014/30/EU, 1999/5/KE, 1999/519/KE, 2009/125/KE , u 2011/65/EU.
<b>hu</b> Magyar [Hungarian]	Alulírott, TRENDnet nyilatkozom, hogy a TEW-821DAPmegfelel a vonatkozó alapvető követelményeknek és az 2014/35/EU, 2014/30/EU, 1999/5/KE, 1999/519/K E,2009/125/KE, irányelv és a 2011/65/EU irányelv egyéb előírásainak.
<b>pl</b> Polski [Polish]	Niniejszym TRENDnet oświadcza, że TEW-821DAP jest zgodny z zasadniczymi wymogami oraz pozostałymi stosownymi postanowieniami Dyrektywy 2014/35/EU, 2014/30/EU, 1999/5/WE, 1999/519/WE, 2009/125/WE i 2011/65/EU.
<b>pt</b> Português [Portuguese]	TRENDnet declara que este TEW-821DAP está conforme com os requisitos essenciais e outras disposições da Directiva 2014/35/EU, 2014/30/EU, 1999/5/CE, 1999/519/CE, 2009/125/CE e 2011/65/EU.
<b>sl</b> Slovensko [Slovenian]	TRENDnet izjavlja, da je ta TEW-821DAP v skladu z bistvenimi zahtevami in ostalimi relevantnimi določili direktive 2014/35/EU, 2014/30/EU, 1999/5/ES, 1999/519/EU, 2009/125/ES in 2011/65/EU.
Slovensky [Slovak]	TRENDnettýmto vyhlasuje, že TEW-821DAPspĺňazákladnépožiadavky a všetkypríslušnéustanoveniaSmernice 2014/35/EU, 2014/30/EU, 1999/5/ES, 1999/519/ES, 2009/125/ES, a 2011/65/EU.
<b>fi</b> Suomi [Finnish]	TRENDnet vakuuttaa täten että TEW-821DAP tyyppinen laite on direktiivin 2014/35/EU, 2014/30/EU, 1999/5/EY, 1999/519/EY, 2009/125/EY, ja 2011/65/EU oleellisten vaatimusten ja sitä koskevien direktiivin muiden ehtojen mukainen.
<b>sv</b> Svenska [Swedish]	Härmed intygar TRENDnet att denna TEW-821DAP står i överensstämmelse med de väsentliga egenskapskrav och övriga relevanta bestämmelser som framgår av direktiv 2014/35/EU, 2014/30/EY, 1999/5/EG, 2009/519/EG, 2009/125/EG, och 2011/65/EU.

**Industry Canada Statement**

This device complies with Industry Canada license-exempt RSS standard(s). Operation is subject to the following two conditions: (1) this device may not cause interference, and (2) this device must accept any interference, including interference that may cause undesired operation of the device.

*Le présent appareil est conforme aux CNR d'Industrie Canada applicables aux appareils radio exempts de licence. L'exploitation est autorisée aux deux conditions suivantes : (1) l'appareil ne doit pas produire de brouillage, et (2) l'utilisateur de l'appareil doit accepter tout brouillage radioélectrique subi, même si le brouillage est susceptible d'en compromettre le fonctionnement.*

**Radiation Exposure Statement:**

This equipment complies with IC radiation exposure limits set forth for an uncontrolled environment. This equipment should be installed and operated with minimum distance 20cm between the radiator & your body.

**Déclaration d'exposition aux radiations:**

Cet équipement est conforme aux limites d'exposition aux rayonnements IC établies pour un environnement non contrôlé. Cet équipement doit être installé et utilisé avec un minimum de 20 cm de distance entre la source de rayonnement et votre corps.

## Limited Warranty

---

TRENDnet warrants only to the original purchaser of this product from a TRENDnet authorized reseller or distributor that this product will be free from defects in material and workmanship under normal use and service. This limited warranty is non-transferable and does not apply to any purchaser who bought the product from a reseller or distributor not authorized by TRENDnet, including but not limited to purchases from Internet auction sites.

### Limited Warranty

TRENDnet warrants its products against defects in material and workmanship, under normal use and service. Specific warranty periods are listed on each of the respective product pages on the TRENDnet website.

- AC/DC Power Adapter, Cooling Fan, and Power Supply carry a one-year warranty.

### Limited Lifetime Warranty

TRENDnet offers a limited lifetime warranty for all of its metal-enclosed network switches that have been purchased in the United States/Canada on or after 1/1/2015.

- Cooling fan and internal power supply carry a one-year warranty

To obtain an RMA, the ORIGINAL PURCHASER must show Proof of Purchase and return the unit to the address provided. The customer is responsible for any shipping-related costs that may occur. Replacement goods will be shipped back to the customer at TRENDnet's expense.

Upon receiving the RMA unit, TRENDnet may repair the unit using refurbished parts. In the event that the RMA unit needs to be replaced, TRENDnet may replace it with a refurbished product of the same or comparable model.

In the event that, after evaluation, TRENDnet cannot replace the defective product or there is no comparable model available, we will refund the depreciated value of the product.

If a product does not operate as warranted during the applicable warranty period, TRENDnet shall reserve the right, at its expense, to repair or replace the defective product or part and deliver an equivalent product or part to the customer. The repair/replacement unit's warranty continues from the original date of purchase. All products that are replaced become the property of TRENDnet. Replacement products may be new or reconditioned. TRENDnet does not issue refunds or credit. Please contact the point-of-purchase for their return policies.

TRENDnet shall not be responsible for any software, firmware, information, or memory data of customer contained in, stored on, or integrated with any products returned to TRENDnet pursuant to any warranty.

There are no user serviceable parts inside the product. Do not remove or attempt to service the product by any unauthorized service center. This warranty is voided if (i) the product has been modified or repaired by any unauthorized service center, (ii) the product was subject to accident, abuse, or improper use, or (iii) the product was subject to conditions more severe than those specified in the manual.

Warranty service may be obtained by contacting TRENDnet within the applicable warranty period and providing a copy of the dated proof of the purchase. Upon proper submission of required documentation, a Return Material Authorization (RMA) number will be issued. An RMA number is required in order to initiate warranty service support for all TRENDnet products. Products that are sent to TRENDnet for RMA service must have the RMA number marked on the outside of return packages and sent to TRENDnet prepaid, insured and packaged appropriately for safe shipment. International customers

shipping from outside of the USA and Canada are responsible for any return shipping and/or customs charges, including but not limited to, duty, tax, and other fees.

**Refurbished product:** Refurbished products carry a 90-day warranty after date of purchase. Please retain the dated sales receipt with purchase price clearly visible as evidence of the original purchaser's date of purchase. Replacement products may be refurbished or contain refurbished materials. If TRENDnet, by its sole determination, is unable to replace the defective product, we will offer a refund for the depreciated value of the product.

**WARRANTIES EXCLUSIVE:** IF THE TRENDNET PRODUCT DOES NOT OPERATE AS WARRANTED ABOVE, THE CUSTOMER'S SOLE REMEDY SHALL BE, AT TRENDNET'S OPTION, REPAIR OR REPLACE. THE FOREGOING WARRANTIES AND REMEDIES ARE EXCLUSIVE AND ARE IN LIEU OF ALL OTHER WARRANTIES, EXPRESSED OR IMPLIED, EITHER IN FACT OR BY OPERATION OF LAW, STATUTORY OR OTHERWISE, INCLUDING WARRANTIES OF MERCHANTABILITY AND FITNESS FOR A PARTICULAR PURPOSE. TRENDNET NEITHER ASSUMES NOR AUTHORIZES ANY OTHER PERSON TO ASSUME FOR IT ANY OTHER LIABILITY IN CONNECTION WITH THE SALE, INSTALLATION, MAINTENANCE, OR USE OF TRENDNET'S PRODUCTS.

TRENDNET SHALL NOT BE LIABLE UNDER THIS WARRANTY IF ITS TESTING AND EXAMINATION DISCLOSE THAT THE ALLEGED DEFECT IN THE PRODUCT DOES NOT EXIST OR WAS CAUSED BY CUSTOMER'S OR ANY THIRD PERSON'S MISUSE, NEGLIGENCE, IMPROPER INSTALLATION OR TESTING, UNAUTHORIZED ATTEMPTS TO REPAIR OR MODIFY, OR ANY OTHER CAUSE BEYOND THE RANGE OF THE INTENDED USE, OR BY ACCIDENT, FIRE, LIGHTNING, OR OTHER HAZARD.

LIMITATION OF LIABILITY: TO THE FULL EXTENT ALLOWED BY LAW, TRENDNET ALSO EXCLUDES FOR ITSELF AND ITS SUPPLIERS ANY LIABILITY, WHETHER BASED IN

CONTRACT OR TORT (INCLUDING NEGLIGENCE), FOR INCIDENTAL, CONSEQUENTIAL, INDIRECT, SPECIAL, OR PUNITIVE DAMAGES OF ANY KIND, OR FOR LOSS OF REVENUE OR PROFITS, LOSS OF BUSINESS, LOSS OF INFORMATION OR DATE, OR OTHER FINANCIAL LOSS ARISING OUT OF OR IN CONNECTION WITH THE SALE, INSTALLATION, MAINTENANCE, USE, PERFORMANCE, FAILURE, OR INTERRUPTION OF THE POSSIBILITY OF SUCH DAMAGES, AND LIMITS ITS LIABILITY TO REPAIR, REPLACEMENT, OR REFUND OF THE PURCHASE PRICE PAID, AT TRENDNET'S OPTION. THIS DISCLAIMER OF LIABILITY FOR DAMAGES WILL NOT BE AFFECTED IF ANY REMEDY PROVIDED HEREIN SHALL FAIL OF ITS ESSENTIAL PURPOSE.

**Governing Law:** This Limited Warranty shall be governed by the laws of the state of California.

Some TRENDnet products include software code written by third party developers. These codes are subject to the GNU General Public License ("GPL") or GNU Lesser General Public License ("LGPL").

Visit <http://www.trendnet.com/gpl> or the support section on <http://www.trendnet.com> and search for the desired TRENDnet product to access to the GPL Code or LGPL Code. These codes are distributed WITHOUT WARRANTY and are subject to the copyrights of the developers. TRENDnet does not provide technical support for these codes. Please visit <http://www.gnu.org/licenses/gpl.txt> or <http://www.gnu.org/licenses/lgpl.txt> for specific terms of each license.

PWP07172015v3

2017/9/15



## Product Warranty Registration

Please take a moment to register your product online.  
Go to TRENDnet's website at <http://www.trendnet.com/register>

TRENDnet  
20675 Manhattan Place  
Torrance, CA 90501. USA