

TRENDnet[®]



Quick Installation Guide
TEW-740APB0

Table of Content

1 English

1. Before You Start
2. Hardware Configuration
3. Hardware Installation

1. Before You Start

Package Contents

- TEW-740APBO
- CD-ROM (User's Guide)
- Quick Installation Guide
- Proprietary PoE injector
- Power adapter (12 V DC, 1 A)
- Mounting Hardware
- Grounding wire

Minimum Requirements

- Computer with a network port and web browser
- A network switch or router with an available network LAN port
- Additional TEW-740APBO H/W: v2.xR wireless N300 directional access point
- 4 x RJ-45 network cables

Note:

It is recommended to use network cables without additional caps, molded caps, or boots with the access points for cable fitment inside the enclosure.

Note:

The TEW-740APBO does not support IEEE 802.3at/af PoE standards. You must use the proprietary Power over Ethernet injector that is supplied with the TEW-740APBO. This installation guide will walk you through the installation and configuration of two TEW-740APBO access points to establish a wireless point to point bridge using WDS (wireless distribution system). The RJ-45 Ethernet cable between the passive PoE injector and access point can have a maximum length of up to 60 m (197 ft.).

2. Hardware Setup and Configuration

Note:

- The default IP address of the TEW-740APB0 is 192.168.10.100. To configure the TEW-740APB0, your network adapter must have an IP address within the 192.168.10.x subnet (e.g. 192.168.10.10). Please refer to the Appendix in the User's Guide for more information.
- The initial configuration should be completed in a testing environment with two TEW-740APB0 access points approximately 15 ft. (5 m) apart from one another with the front of the access points directly facing each other.
- Configure and connect the access points before mounting.

Phase 1: Overview

In this installation guide, we will assume the following:

Router Settings:

Router/Default Gateway IP address: 192.168.10.1

Subnet Mask: 255.255.255.0

The TEW-740APB0 access points will be configured with the following settings:

TEW-740APB0 #1

IP Address: 192.168.10.50

Netmask (Subnet Mask): 255.255.255.0

IP Gateway (Default Gateway): 192.168.10.1

Primary DNS: 192.168.10.1

Wireless Channel (Default): 1

WDS AES Encryption

TEW-740APB0 #2

IP Address: 192.168.10.51

Netmask (Subnet Mask): 255.255.255.0

IP Gateway (Default Gateway): 192.168.10.1

Primary DNS: 192.168.10.1

Wireless Channel (Default): 1

WDS AES Encryption

In this example, we will assume the device use the following MAC addresses:

TEW-740APB0 #1 MAC Address: 00:11:22:33:44:00

TEW-740APB0 #2 MAC Address: 00:11:22:33:44:11

Phase 2: TEW-740APB0 Unit #1 Hardware Setup and Configuration

1. Remove the cover of the access point by pulling and holding the tab in the vertical direction upward (based on the access point orientation below) and sliding the cover in the two locations noted below away from the access point.

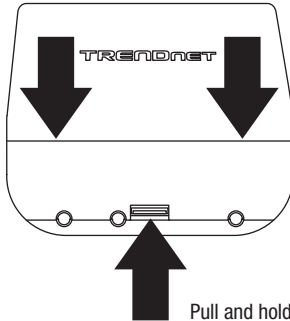

Pull and hold tab

2. Write down the MAC address (WiFi MAC) of the TEW-740APB0 #1 access point. The MAC address (WiFi MAC) can be found on the inside of the device cover where the Ethernet LAN ports are located (shown below).

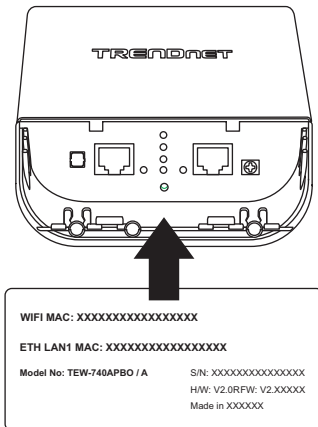

3. Remove the tab on the far left by gently bending it back and forth until the tab is removed. This will create the opening for a RJ-45 network cable to be routed through.

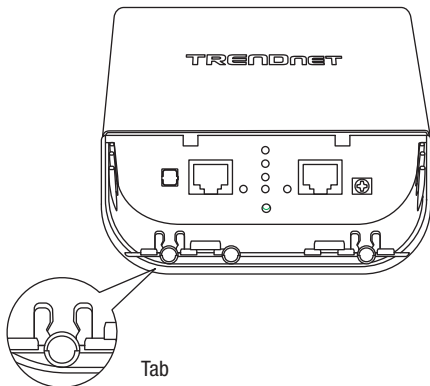

4. Using a network cable, connect one end of the cable to the LAN (PoE) port and push the cable into the cable guide on the far left, then through the opening that was created in the previous step.

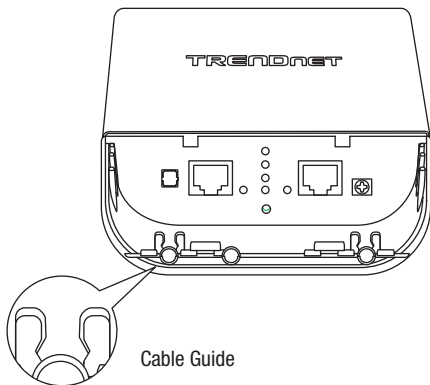

5. Connect the other end of the network cable to the **P+DATA OUT** port on the included PoE injector.
6. Using another network cable, connect one end to the **10/100 DATA IN** port on the included PoE injector.
7. Connect the other end of the network cable to your computer's Ethernet port.
8. Connect the included power adapter to the PoE injector **POWER IN** on the included PoE injector.
9. Plug the connected power adapter into a power outlet.
10. Confirm the device is powered on through the LED indicators.

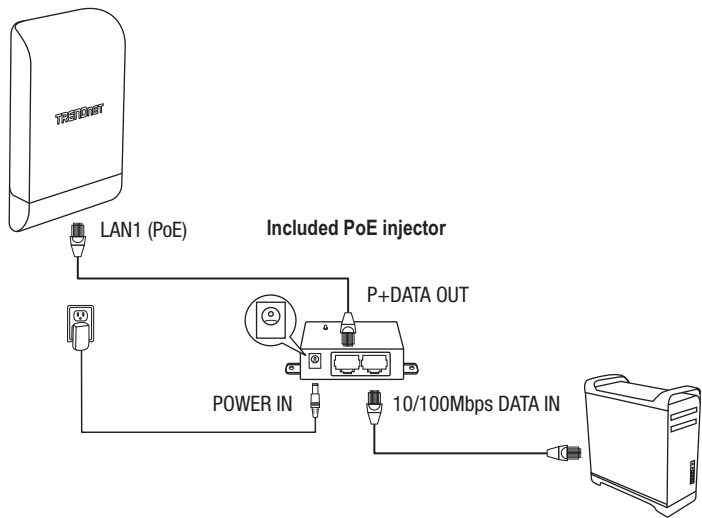

11. Assign a static IP address to your computer's network adapter in the subnet of 192.168.10.x (e.g. 192.168.10.10) and subnet mask of 255.255.255.0.

12. Open your web browser and type the IP address of the access point in the address bar, then press **Enter**. The default IP address is 192.168.10.100.

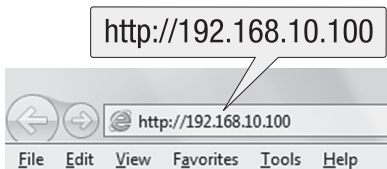

13. When prompted, login to the browser configuration page using the default user name and password settings.

User Name: **admin**

Password: **admin**

Note: User Name and Password are case sensitive.

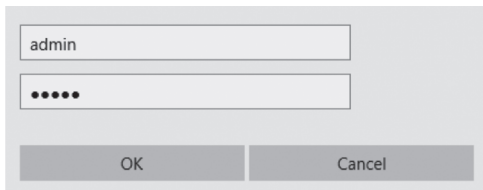

14. Click on the **System** tab and select **Management**.

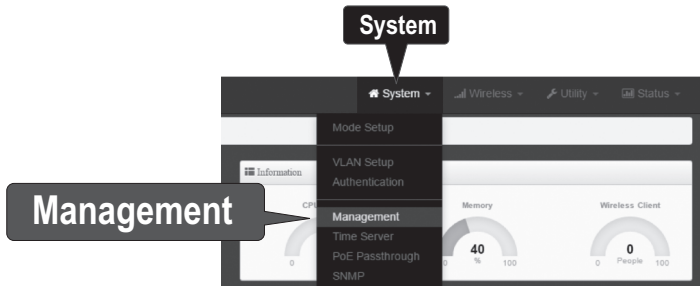

15. Under **Administrator Password**, change the default administrator password by typing in your new password in the fields provided and then click the **Save** button at the bottom of the page.

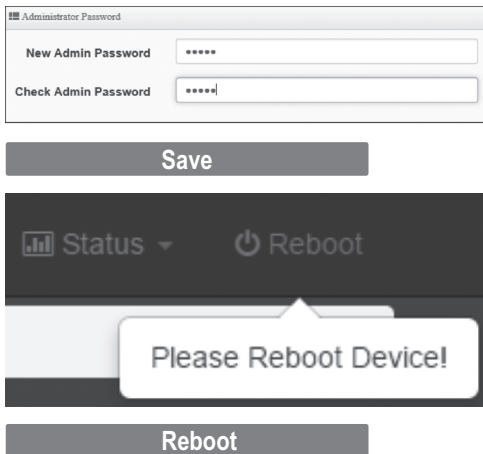

The image shows a web interface for changing the administrator password. At the top is a form titled "Administrator Password" with two input fields: "New Admin Password" and "Check Admin Password", both containing six asterisks. Below the form is a large grey button labeled "Save". Underneath is a dark grey navigation bar with "Status" and "Reboot" options. A white callout box with a pointer to the "Reboot" button contains the text "Please Reboot Device!". Below this is another large grey button labeled "Reboot".

16. After the device saves changes and reboots, in the top menu, click on the **System** and click on **Mode Setup**.

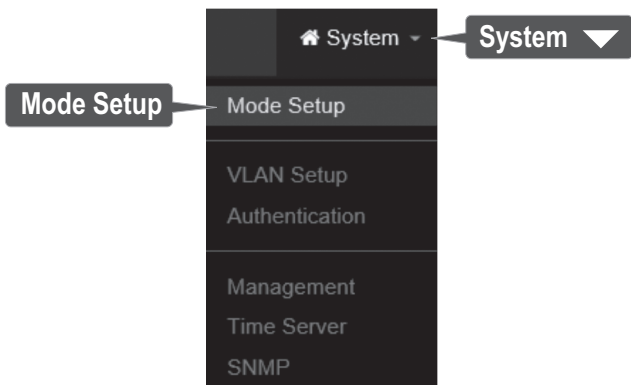

17. Click on the **Mode** field and click on **WDS Mode**. Then click **Save & Reboot** and when prompted to change settings, click **Yes** to reboot the device and apply the changes.

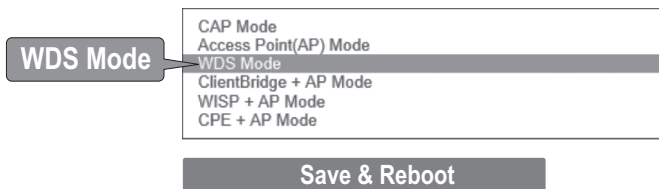

18. In the top menu, click on **System** and click on **VLAN Setup**.

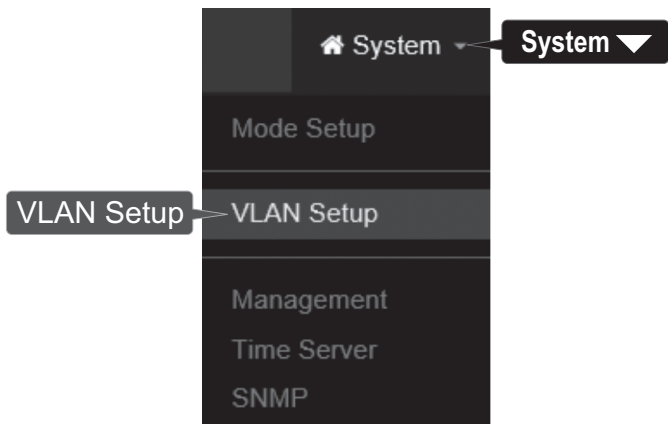

19. For the first entry in the VLAN List under the action column, click **Network**.

#	VLAN Mode	Flag	IP Address	Netmask	Action
0	En	Native ET10, Native ET11, Access Control	192.168.10.100	255.255.255.0	Network



20. In the IP Setup section, enter the IP Address **192.168.10.50** and Netmask **255.255.255.0**. Then click **Save**. In the menu located at the top, you will be prompted to reboot the device. Click the **Reboot** button and in the following page, click **Reboot**. When prompted to change settings, click **Yes** to reboot the device and apply the changes.

Note: When configuring TEW-740APBO #2, enter the IP address settings 192.168.10.51 and Netmask 255.255.255.0.

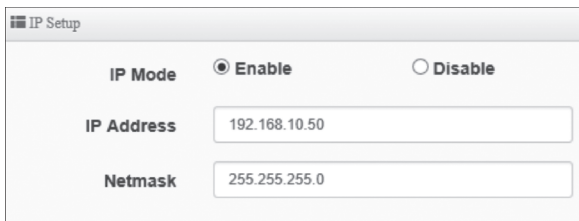

IP Setup	
IP Mode	<input checked="" type="radio"/> Enable <input type="radio"/> Disable
IP Address	<input type="text" value="192.168.10.50"/>
Netmask	<input type="text" value="255.255.255.0"/>

21. Click on the **Wireless** tab and select **Radio 0 Basic Setup**. Make sure **Channel 1** is selected and click **Save**.

Note: When configuring TEW-740APBO #2, the wireless channel must be the same as TEW-740APBO #1.

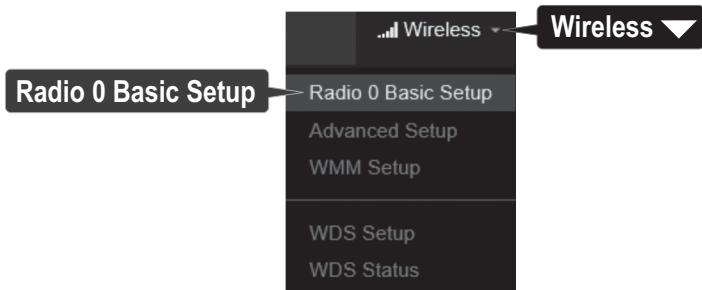

22. Click on the **Wireless** tab and select **WDS Setup**.

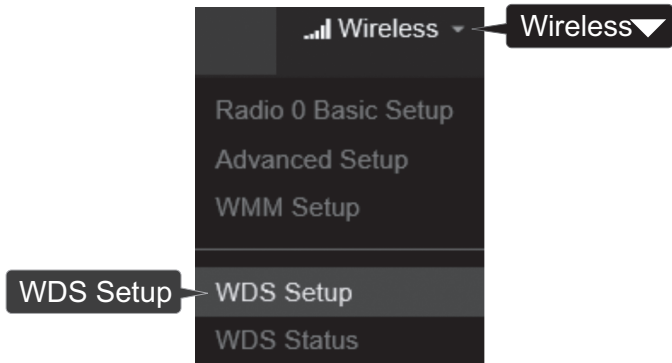

23. Click **Enabled** for the WDS Setup and under Authentication, select **AES**. Enter a WDS **PassPhrase** (8-63 alphanumeric characters).

Note: When configuring TEW-740APB0 Unit #2, the WDS AES Passphrase must be the same as TEW-740ABP0 #1.

A screenshot of the 'WDS Setup' configuration page. It shows the following fields:

- WDS Setup:** Radio buttons for 'Enable' (selected) and 'Disable'.
- ESSID:** Text input field containing 'TRENDnet_740_wds'.
- Authentication:** Dropdown menu set to 'AES'.
- PassPhrase:** Text input field containing 'XXXXXXXXXXXXXX'.

24. Under WDS Client Setup, check the first entry and enter the WiFi MAC address of TEW-740APB0 #2. Then click **Save**.

Note: When configuring the TEW-740APB0 #2, enter the WiFi MAC address of TEW-740APB0 #1.

A screenshot of the 'WDS Client Setup' table. The table has two columns: 'Enable' and 'MAC Address'.

Enable	MAC Address
<input checked="" type="checkbox"/>	<input type="text" value="00:11:22:33:44:11"/>

25. When prompted, click **Reboot** at the top of the page, click the **Reboot** button, and click **Yes** to reboot and apply the configuration changes.

Note: After the device reboots and applies changes, you will need to reconnect to device configuration page using the new IP address settings.

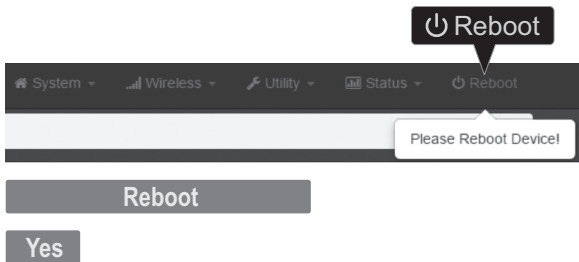

Phase 3: TEW-740APB0 Unit #2 Hardware Setup and Configuration

When configuring the TEW-740APB0 #2, repeat all of the steps in Phase 2 setup and configuration.

- In Step 19 and 20, under IP Setup, enter the IP Address **192.168.10.51** and Netmask **255.255.255.0**. Then click **Save**.

IP Setup	
IP Mode	<input checked="" type="radio"/> Enable <input type="radio"/> Disable
IP Address	<input type="text" value="192.168.10.51"/>
Netmask	<input type="text" value="255.255.255.0"/>

- In Step 24, under WDS Client Setup, enter the WiFi MAC address of TEW-740APB0 Unit #1. Then click **Save**.

WDS Client Setup	
Enable	MAC Address
<input checked="" type="checkbox"/>	<input type="text" value="00:11:22:33:44:00"/>

Phase 4: Confirm Connectivity

1. Leave your computer connected to TEW-740APBO #2 and keep the web management interface open.
2. Make sure both TEW-740APBO #1 and TEW-740APBO #2 access points are powered on approximately 15 ft. (5 m) apart from one another with front of access points directly facing each other.

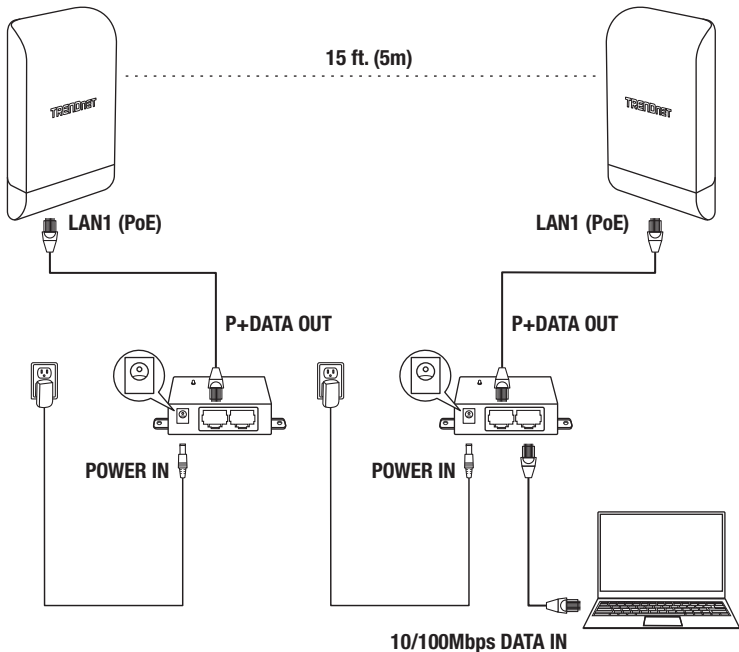
TEW-740APBO #1**TEW-740APBO #2**

3. To verify connectivity, in the TEW-740APB0 #2 web management interface, click on **Utility** and click on **Network Utility**.

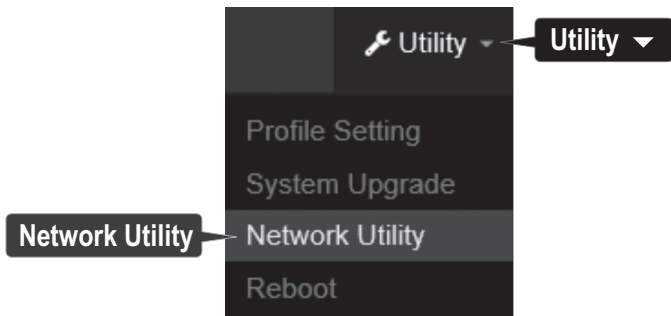

4. In the **IP/Domain** field, enter the IP address of TEW-740APB0 #1, 192.168.10.50, then next to **Times**, click **Ping**.

5. Ping replies and 0% packet loss will indicate as successful point to point bridge connection between the TEW-740APB0 #1 and #2.

Note: If the connectivity test fails, wait for about a minute and try again. Make sure there are no obstacles between the two access points when running the connectivity test and make sure the two access points are not too close together.

```

PING 192.168.10.50 (192.168.10.50): 56 data bytes
64 bytes from 192.168.10.50: icmp_seq=0 ttl=64 time=10.3 ms
64 bytes from 192.168.10.50: icmp_seq=1 ttl=64 time=0.2 ms
64 bytes from 192.168.10.50: icmp_seq=2 ttl=64 time=0.2 ms
64 bytes from 192.168.10.50: icmp_seq=3 ttl=64 time=0.2 ms
64 bytes from 192.168.10.50: icmp_seq=4 ttl=64 time=0.2 ms

--- 192.168.10.50 ping statistics ---
5 packets transmitted, 5 packets received, 0% packet loss
round-trip min/avg/max = 0.2/2.2/10.3 ms
  
```

3. Ground Wire and Pole Mount Installation

1. Locate the grounding point located in the bottom section of the enclosure. Using a Phillips screwdriver, remove the grounding point screw (counter clockwise) and attach the included grounding wire to the grounding point screw. Reattach the ground screw (clockwise) along with the grounding wire. After installing the grounding wire, remove another tab on the enclosure by gently bending back and forth until the tab is removed. This will create the opening for the ground cable to be routed through.

Note: The ground wire may need to be cut and extended using additional ground wire in order to reach a proper grounding point.

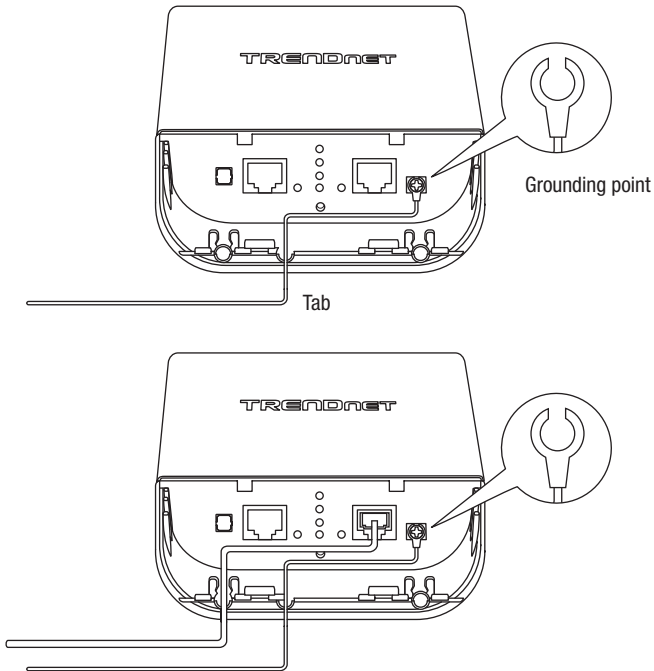

2. Re-install the cover by lining up the guides into the notches as shown and push the cover down until the cover clips in and is secure.

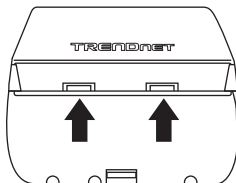

3. Insert the included fasteners through the holes located at the back of the access point.

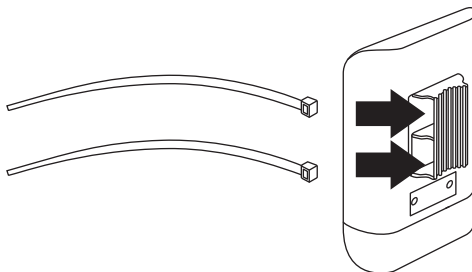

4. Wrap the fasteners around the pole where the access points will be installed. On the fasteners, insert the open end into the locking mechanism and pull tight until the access point is secured.

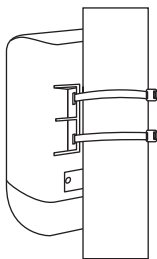

5. After the access points are properly mounted, you can connect the grounding wires to the proper ground points and RJ-45 cables from each access point to your network.

Completed Installation Reference

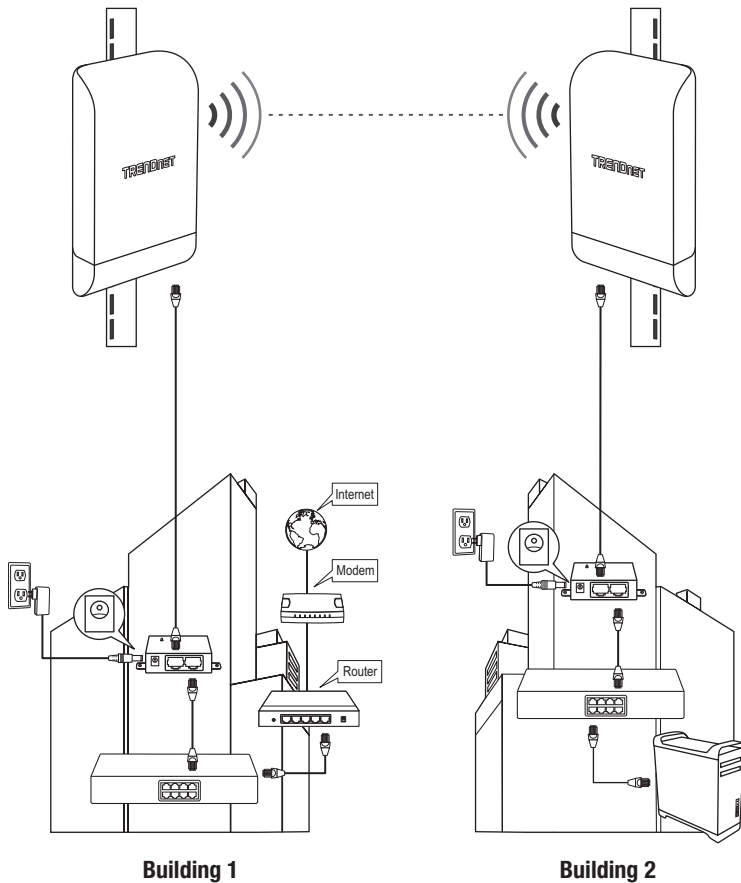

Declaration of Conformity

TRENDnet[®]

Manufacturer's Name and Address

TRENDnet, Inc.
20675 Manhattan Place
Torrance, CA 90501 USA



Zwolsestraat 156 2587 WB
The Hague The Netherlands

Product Information:

Model Number: TEW-740APBO / TEW-740APBO2K
Product Name: 10 dBi Wireless N300 Outdoor PoE Access Point /
10 dBi Wireless N300 Outdoor PoE Preconfigured Point-to-Point Bridge Kit
Trade Name: TRENDnet

TRENDnet hereby declare that the product is in compliance with the essential requirements and other relevant provisions under our sole responsibility.

Safety

EN 60950-1: 2006 + A11: 2010 + A12: 2011 + A2: 2013

EMC

EN 301 489-1 V1.9.2: 09-2011
EN 301 489-17 V2.2.1: 09-2012
EN 55024: 2010 + A1: 2015
EN 55032: 2015

Radio Spectrum & Health

EN 300 328 V1.9.1: 02-2015
EN 62311: 2008

Energy Efficiency

Regulation (EC) No. 1275/2008, No. 801/2013

This product is herewith confirmed to comply with the Directives.

Directives:

Low Voltage Directive 2014/35/EU
EMC Directive 2014/30/EU
RED Directive 2014/53/EU
RoHS Directive 2011/65/EU
REACH Regulation (EC) No. 1907/2006

Note:

This device is designed to provide uninterrupted operation. This device does not offer power management functionality such as Off mode or Standby mode.

Person responsible for this declaration.

Place of Issue: Torrance, California, USA

Date: December 09, 2016

Name: Sonny Su

Title: Director of Technology

Signature:

A handwritten signature in black ink, appearing to read 'Sonny Su', is written over a horizontal line.

Limited Warranty

TRENDnet warrants its products against defects in material and workmanship, under normal use and service. Specific warranty periods are listed on each of the respective product pages on the TRENDnet website.

Garantie Limitée

TRENDnet garantit ses produits contre les problèmes de matériel ou de fabrication, dans des conditions normales d'utilisation et de service. Les périodes de garanties précises sont mentionnées sur chacun des pages produits du site web de TRENDnet.

Eingeschränkte Garantie

TRENDnet gewährt eine Garantie für seine Produkte im Falle von Material- und Bearbeitungsdefekten, bei normaler Verwendung und Wartung. Spezielle Garantiezeiträume werden auf jeder Produktseite auf der Website von TRENDnet genannt.

Garantía limitada

TRENDnet garantiza que sus productos carecen de defectos en el material y la fabricación, en condiciones de uso y funcionamiento normales. Los periodos específicos de garantía figuran en cada una de las páginas de producto del sitio web de TRENDnet.

Ограниченная гарантия

Компания TRENDnet предоставляет гарантию на свои изделия от дефектов материалов и сборки при нормальном использовании и обслуживании. Конкретные гарантийные сроки указаны на странице каждого продукта на сайте компании TRENDnet.

Garantia Limitada

A TRENDnet garante seus produtos contra defeitos de material e mão de obra sob condições normais de uso e serviço. Os períodos de garantia específicos estão listados em cada uma das páginas dos respectivos produtos no site da TRENDnet.

Piiratud garantii

TRENDneti garantii hõlmab materjali- ja koostamisdefekte, mis ilmnevad toote tavapärasel kasutamisel. Garantiiaja täpne pikkus konkretse toote puhul on leitav TRENDneti kodulehelt vastava toote infolehel.

Garanzia limitata

TRENDnet garantisce i propri prodotti da difetti di materiali e manodopera, in condizioni di normale uso ed esercizio. I periodi di garanzia specifici sono elencati sulle rispettive pagine di prodotto sul sito TRENDnet.

Certifications

This device complies with Part 15 of the FCC Rules.

Operation is subject to the following two conditions:

- (1) This device may not cause harmful interference.
- (2) This device must accept any interference received.
Including interference that may cause undesired operation.



Waste electrical and electronic products must not be disposed of with household waste. Please recycle where facilities exist. Check with your Local Authority or Retailer for recycling advice.

Technical Support

If you have any questions regarding the product installation, please contact our Technical Support.

Toll free US/Canada: **1-866-845-3673**

Regional phone numbers available
at www.trendnet.com/support

TRENDnet

20675 Manhattan Place
Torrance, CA 90501
USA

Applies to PoE Products Only: This product is to be connected only to PoE networks without routing to the outside plant.

Note

The Manufacturer is not responsible for any radio or TV interference caused by unauthorized modifications to this equipment. Such modifications could void the user's authority to operate the equipment.

Advertencia

En todos nuestros equipos se mencionan claramente las características del adaptador de alimentación necesario para su funcionamiento. El uso de un adaptador distinto al mencionado puede producir daños físicos y/o daños al equipo conectado. El adaptador de alimentación debe operar con voltaje y frecuencia de la energía eléctrica domiciliar existente en el país o zona de instalación.

Product Warranty Registration

Please take a moment to register your product online. Go to TRENDnet's website at:
www.trendnet.com/register