

TEW-412APBO/TEW-413APBO

Wireless 11g Outdoor AP Bridge
Quick Installation Guide

Guide d'installation rapide du
Pont et point d'accès sans fil 11g pour extérieur

Anleitung zur Schnellinstallation des
Drahtloser 11g Außen-AP/Bridge

Guía de instalación rápida del
AP Inalámbrico para exteriores a 11g

Version 03.02.2005



TRENDnet[®]
TRENDware, USA
What's Next in Networking

Table of Contents

English	1
1. Introduction	1
2. Connect and power up the AP/Bridge	2
3. Configuring a setup computer on the LAN	4
4. Configuring the AP/Bridge	5
5. Quick test (Post test)	8
Troubleshooting	10

English QIG

1. Introduction

Hardware requirement List

When setting up the TEW-412APBO/TEW-413APBO inter-building AP/Bridge, you will need the following:



Additional Requirement

1. A computer connected to the same network as the AP/Bridge.
2. Straight-through CAT 5 Ethernet cable with RJ-45 connectors for connecting the router to the network and an inline power source (maximum 100 meters).
3. The following information is needed from your network system administrator.
 - The wireless Service Set Identifier (SSID) for your radio network. This parameter is case-sensitive.
 - A unique IP address for the router (for example: 192.168.2.123), if it will not be connected to a network with a DHCP server.
 - A default gateway and subnet mask if the router is not on the same subnet as your PC.

2. Connect and power up the AP/Bridge

Mounting the AP/Bridge

- Step 1** Assemble the mount kit at the back of the case. Please refer to the attached figure in the mount kit tool bag for more details.
- Step 2** Mount the AP/Bridge on a stout pole.
- Step 3** Adjust the orientation of the antenna to get the maximum range (See Figure 3.1). (Note: In some units, the directional flat panel antenna is embedded within the enclosure; the best reception will be directly through the front panel).



Figure 3.1: Adjusting TEW-412APBO/TEW-413APBO for best reception

- Step 4** Secure the unit in the position.

Connect to the power source and the local network

- Step 1** Connect the Ethernet cable from the TEW-412APBO/TEW-413APBO AP/Bridge to the port on the POE (Power over Ethernet) host (PH-110 Power LAN 1 port hub) labeled **P-LAN OUT**.
- Step 2** Connect a straight-through Ethernet cable from the LAN-IN port of the POE host to a spare port on the hub or a switch within the local network.

The steps described above are summarized in the Figure 3.2.

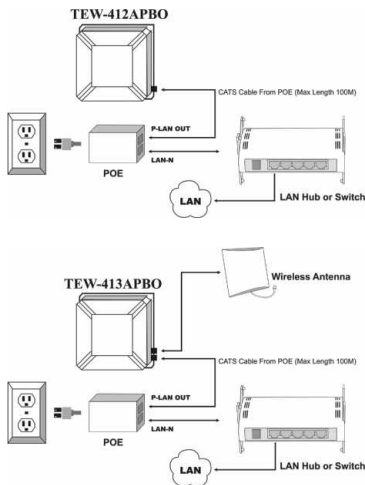

Figure 3.2: Connecting TEW-412APBO/TEW-413APBO to the power source and to the network

In the next section, we will discuss the procedure to setup a computer on the local network, so we can use it to configure the AP/Bridge.

3. Configuring a setup computer on the LAN

To configure the TEW-412APBO/TEW-413APBO for the first time, you should prepare one computer for the TEW-412APBO/TEW-413APBO setup. The operating system of this computer can be Windows, Linux, or MAC with the standard browsers (e.g., Netscape or Microsoft Internet Explorer versions 4.0 or later).

The usual factory settings for the TEW-412APBO/TEW-413APBO are:

IP address: 192.168.1.250
Netmask: 255.255.255.0

This computer must be connected to the same LAN as the TEW-412APBO/TEW-413APBO, and the network of this computer should contain the following parameters:

IP address: A free IP address in the 192.168.1.1 - 192.168.1.253
EXCEPT 192.168.1.250
Netmask: 255.255.255.0
Default Gateway: None

For example, under Microsoft Windows XP, the TCP/IP network settings page would look like the following:

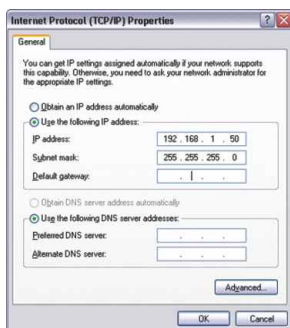

Sample MS Windows XP network settings

After setting these values on the LAN connected computer, the initial setup process, as described in the next section can be started.

4. Configuring the AP/Bridge

After the TEW-412APBO/TEW-413APBO AP/Bridge is connected to your network, you can begin to manage the router through a standard web browser.

To use a browser to setup TEW-412APBO/TEW-413APBO, follow these steps:

1. Launch a web browser on a computer connected to the network.
2. Enter the AP/Bridge's IP address in the browser address line and press **Enter**. The default IP address of TEW-412APBO/TEW-413APBO AP/Bridge is **192.168.1.250**, so type **http://192.168.1.250** as the URL in your web browser. It may look like the following:



3. Type in "admin" for the **user name** and type in "admin" for the **password**. Click **OK**.

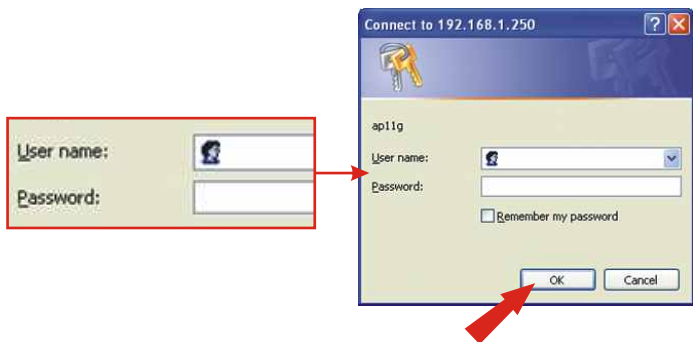

4. Scroll down to the **LAN** section and type in the **IP Address**, the **Subnet Mask**, and the **Gateway** that applies to your current networking settings.

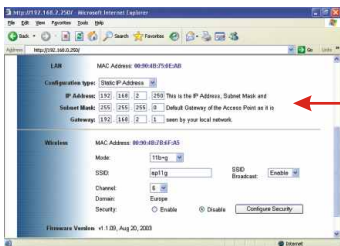

5. Scroll down to the **Wireless** section and change the **SSID** to a name that will help you identify the TEW-412APBO/TEW-413APBO. In this example, the **SSID** will be changed to **TEW-412APBO**.

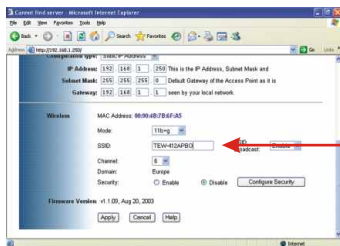

6. Click **Continue**.

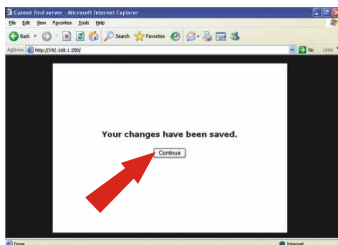

Your AP should now be up and running. Consult the User's Guide on the CD for a description of the AP/Bridge system management functions and the instructions to access the Help Guide.

5. Quick test (Post test)

From a Wireless Computer

(using TRENDnet's TEW-424UB as an example in this section)

The settings of the Access Point are:

SSID - TEW-412APBO

Channel - 6

1. Double-click the wireless computer icon in your system tray (next to the clock in the bottom right corner of your screen).



2. Click the **SSID** that you assigned to the TEW-412APBO/TEW-413APBO and click **Connect**.

SSID	MAC Address
TNET	00-90-4B-A0-41-F3
TEW-412APBO	00-90-4B-75-0E-AB

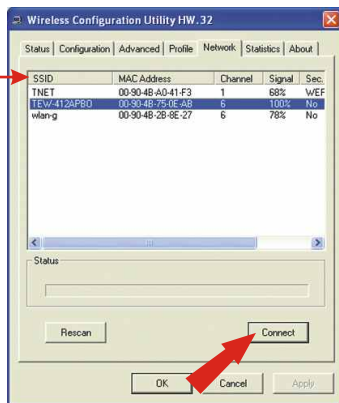

3. Click **Status** and verify that the TEW-424UB is connected to the TEW-412APBO/TEW-413APBO.

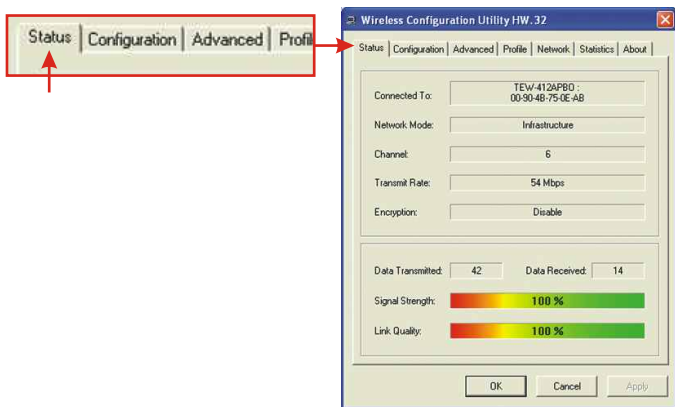

Q1. I specified the IP address `http://192.168.1.250` in my internet browser's address bar, but an error message says "The page cannot be displayed". How can I get into the TEW-412APBO/413APBO's web configuration page?

A1. Make sure that **POWER**, **WIRELESS**, and **LAN** LED's are on, and make sure that the computer you are using does NOT have this IP address: 192.168.1.250. Please refer to page 7, "Configuring a setup computer on LAN" to configure your access point.

Q2. If my network's subnet is different than the Access Point's range, what should I do?

A2. You should still configure the access point first. After all the settings are applied, go to the Access Point's configuration page, click on TCP/IP settings and change the IP address for the Access Point to match your network's subnet.

Q3. After I successfully configured the Access Point to meet my network settings, I cannot connect to my network using wireless computers.

A3. If you have a DHCP server in your network, you need to go into TCP/IP settings again and re-select "Obtain an IP automatically" for Windows 98/ME and "Obtain an IP Address automatically" for Windows 2000/XP to allow the PC to regain an IP address from your DHCP server.

If you have any questions regarding the TEW-412APBO/413APBO, please contact Trendware Technical Support Department.

Contact Technical Support

Telephone: +1-310-626-6252
Fax: +1-310-626-6267
Website: www.TRENDNET.com
E-mail: support@trendware.com

Technical Support Hours

7:00AM ~ 6:00PM, Monday through Friday
Pacific Standard Time (except holidays)

Certifications

This equipment has been tested and found to comply with Part 15 of the FCC Rules. Operation is subject to the following two conditions:

- (1) This device may not cause harmful interference.
- (2) This device must accept any interference received.
Including interference that may cause undesired operation.

This equipment is in compliance with the requirements of the following regulations: EN 55 022: CLASS B





Product Warranty Registration

Please take a moment to register your product online.
Go to TRENDware's website at <http://www.TRENDNET.com>

TRENDware International, Inc.
3135 Kashiwa Street
Torrance, CA 90505

<http://www.TRENDNET.com>