

User's Guide

TRENDNET[®]



Outdoor 1.3 MP HD PoE+ Speed Dome Network Camera

TV-IP450P

Contents

Product Overview.....	3
Package Contents	3
Features	3
Cables	4
Protections.....	5
Warnings:.....	5
Cautions:.....	5
Plan for Installation	6
Setup Camera with CD.....	7
Access Camera through the Web Browser	9
System Management and Default Settings	9
Logging-in to the Camera	9
Basic Settings	11
Live View	11
Presets.....	12
Patrols	14
Pattern.....	15
Playback.....	16
Log	18
System	19
Advanced Settings	19
System	19
Device Settings	19
User Accounts.....	20
Time Settings	21
Daylight Savings.....	21

Live View Settings	22
Maintenance.....	23
Network Settings	24
TCP/IP	24
Port	25
DDNS.....	25
PPPoE.....	26
SNMP	26
802.1X	28
IP Address Filter	28
QoS, Quality of Service	29
UPnP	29
Video Settings.....	30
Video Format	30
Audio.....	31
Display Settings.....	31
On Screen Display (OSD) Settings	34
Text Overlay.....	35
Video Recording.....	35
Events	36
Motion Detection	36
Video Tamper	38
Exception	40
Snapshot	41
Email	42
Alarm Input	43
Alarm Output	44
Storage	44
Storage Management	44

Network Storage.....	44
FTP Server.....	45
Pan/Tilt/Zoom (PTZ) Settings.....	46
Basic	46
Limit.....	48
Initial Position.....	48
Park Action	49
Private Mask.....	49
Schedule Tasks	50
Clear Config	51
Reset	51
Software Reset	51
Refer to Advanced Settings, Maintenance section on page 23	51
Hardware Reset	51
Troubleshooting	52

Product Overview



TV-IP450P

(Bracket not included)

Package Contents

In addition to your camera, the package includes:

- TV-IP450P
- CD-ROM (Software & User's Guide)
- Multi-Language Quick Installation Guide
- Installation gloves & waterproof tape
- PoE+ injector

If any package contents are missing or damaged, please contact the retail store, online retailer, or reseller/distributor that the item was purchased from.

Features

TV-IP450P

TRENDnet's Outdoor 1.3 MP HD PoE+ Speed Dome Network Camera, model TV-IP450P, offers powerful 20x optical zoom, low light sensor, an IP66 weather rating, and continuous 360 degree PTZ functionality. Record 1.3 Megapixel HD video (1280 x 960) at 30 fps in a space saving H.264 compression format. Manage up to 32 TRENDnet cameras with included complimentary software and mobile apps. A separate mounting bracket is required—install with TRENDnet's TV-HC400, TV-HW400, TV-HP400, or TV-HN400.

1.3 Megapixel HD

Record 1280 x 960 at 30 fps in the space saving H.264 compression format

Multi-Language Interface

Support for English, French, Spanish, German, and Russian

Time and Text Stamp

Enable time and additional identifying text stamp overlays

Dynamic DNS Support

Support for dyn.com and NO-IP.org services

Auto Patrol

Choose pre-defined or program up to eight auto patrol sequences with varying zoom levels

Storage

Record video to a Samba client or to a Micro SD card (up to 64 GB sold separately)

Tamper Detection

Receive tamper detection snapshots via email, ftp, or save to Samba client or Micro SD card

D-WDR

Improved image quality and autofocus in high contrast lighting environments with Digital Wide Dynamic Range technology

Motion Detection

Create motion detection windows with separate sensitivity settings and event triggers

Recording Schedule

Define a weekly recording schedule

IPv6

IPv6 support

ONVIF

ONVIF compliant

Complimentary Software

Complimentary pro-grade software to manage up to 32 TRENDnet cameras

Complimentary Apps

Live video to a mobile device with free Apple® and Android™ apps

Cables

Connectors for AC power adapter
(Not required when PoE injector is included)

Alarm line in, line out and grounding wires

Audio Line in, line out, and grounding wires

Network cable connection

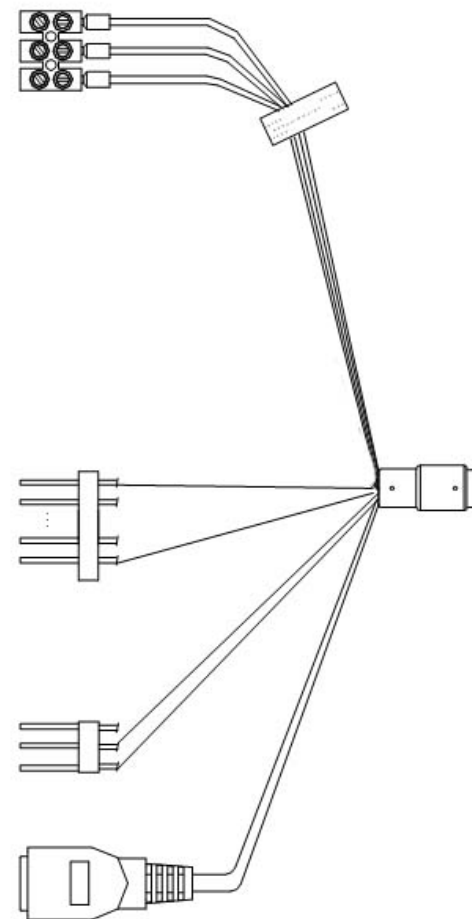

Protections

The protections need to be removed before setting up and using the camera.

- Unlock screws on two sides and remove the dome cover

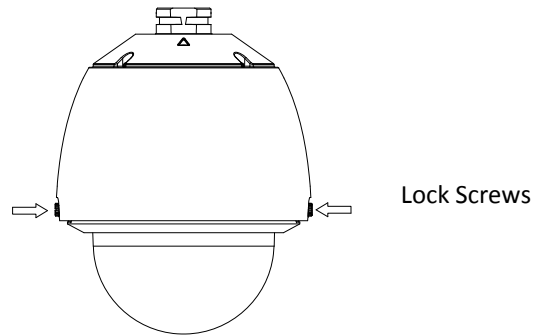

- Remove the protective tape and ring form

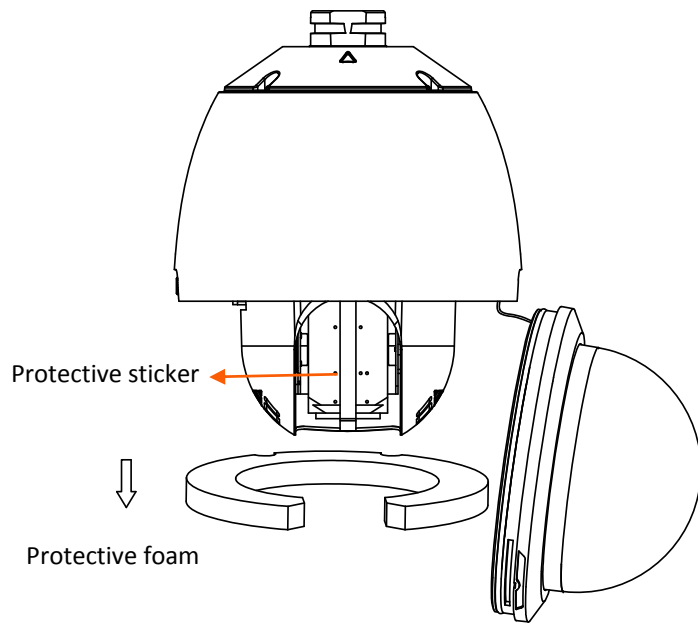

Warnings:

- It is recommended to use the PoE+ injector that comes with the camera or an IEEE 802.3at compliant PoE+ switch.
- If the product does not work properly, please contact your dealer or the nearest service center. Never attempt to disassemble the camera yourself. Disassembling the product will void the warranty and may cause harm or injury.
- The installation should be done by a qualified service person and should conform to all construction and electric regulations and other local codes.

Cautions:

- Make sure the power supply voltage is correct before using the camera.
- Do not drop the camera or subject to physical shock.
- Do not touch sensor modules with fingers. If cleaning is necessary, use a clean cloth with a bit of ethanol and wipe it gently. If the camera will not be used for an extended period of time, put on the lens cap to protect the sensor from dirt.
- Do not aim the camera lens at the strong light such as the Sun or an incandescent lamp. Strong light can damage the camera sensor.
- The sensor may be burned out by a laser beam, so when any laser equipment is being used, make sure that the surface of the sensor will not be exposed to the laser beam.
- Do not place the camera in extremely hot, cold temperatures (the operating temperature should be between -30°C to 65°C), dusty or damp environment, and do not expose it to high electromagnetic radiation.
- To avoid heat accumulation, good ventilation is required for a proper operating environment.
- While shipping, the camera should be packed in its original packing.
- Use water proof tape to cover all the wires, cables which will be exposed outdoor after the camera installation.

Plan for Installation

There are a number of factors involved in successful camera installation. Follow the suggested installation steps and go through the check lists. This guide will help you to make your camera installation smooth and easy.

- **Setup Your Camera with CD**
- **Plan for installation location**
- **Selecting the appropriate mounting accessories, see Mounting Guide**

Viewing angle

- The camera is a vari-focal camera with a wide viewing range that provides non-distorted and detailed images. Choose the location where has good angle to shoot the image you expect to see. The motion detection area should also be considered when installing the camera.

Weather Conditions

- The camera is an outdoor dome camera, which fits most installations indoor and outdoor. The camera can work under a wide range of weather conditions. For severe weather conditions. Using the camera in milder weather conditions will help extend the camera's life and preserve the quality of the camera image.
- **Moisture:** Avoid damp or moist environments whenever you can. The camera is an IP66 grade water proof camera, and it will work in moist environments. However, rain may affect the picture quality, especially at night, water may reflect the light from the infra-red illumination and degrade picture quality.
- **Temperature:** Camera works within a specified temperature range. Areas with severe temperatures should be avoided when installing the camera. It's recommended that you use an enclosure with a heater and blower if you plan on using this camera outside of the specified temperature range.

- **Sunlight:** Avoid direct sun light exposure. Direct sun light will damage the image sensor. If sunlight is necessary for your viewing purposes, provide protection for the image sensor.
- **Lighting:** Consider installing your camera faces the same direction of the light sources. Shooting images with top-down position outdoor or next to the existing light source are good choices. Avoid the light source if it creates a shade that darkens the viewing area.

Setup Camera with CD

1. Insert the Installation CD-ROM into your computer's CD-ROM drive to initiate the Auto-Run program. Choose your preferred language and then click the **Install Camera**. (mounting accessories are not included)



2. Write down the MAC Address of the camera.



3. Remove the protection materials.



4. Connect the power/network cable



5. Wait while the utility searches for the camera.
6. The installation wizard will list cameras found on your network. If only one camera is found, it will be selected by default. If you have more than one camera on the network, please choose the camera you wish to set up by identifying its MAC address. Select the camera and then click **Next**.
7. Select the **DHCP** option to assign IP address dynamically, or select **Fixed IP** to assign the camera an IP address, then click **Next**.
8. If you select **Fixed IP**, enter the IP address, subnet mask, default gateway, and DNS server address. Please make sure the IP address you are setting on the camera is in the same network of the computer that you are using. Click **Next**.
9. Enter a new password. The default password is **admin**. You are required to change the password from the default setting to prevent unauthorized access. Enter the default password: **admin** and enter the new passwords for a brand new installation*. The password must be between 8 and 16 characters. (Alphanumeric: a-z, A-Z, 0-9, !, @, #, \$).

*This camera installation wizard is also good for finding the camera if it was setup with DHCP. The IP address may change dynamically with the DHCP setting. If you want to access your camera again and you don't know the IP address, you can run this camera installation wizard again. If you have already setup the password and want to keep the password unchanged, un-check the **Change Password** box and click next to get the link to access your camera.)

** Please save the password for future references. This device does not have a hardware reset function for temper proof purpose.

10. Click **here** to access to the camera's web page or click **Next** for mobile app installation.

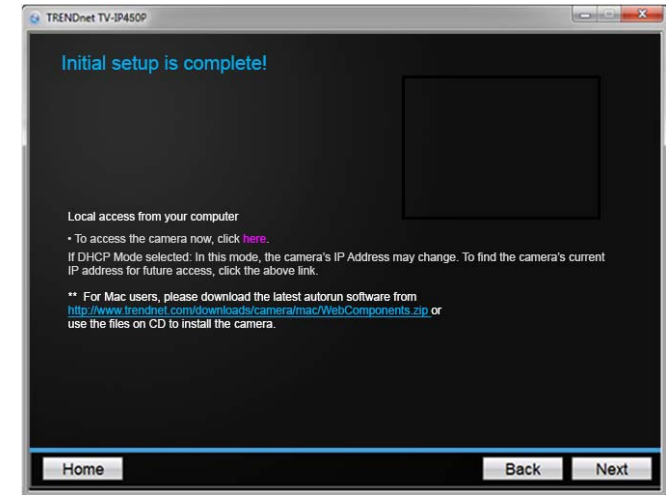

11. Click **Finish** to exit the program or click **Home** to return to the main screen. You can also download a free app to view video on your mobile devices. Scan the QR code to find and install the TRENDnetVIEW app.

Access Camera through the Web Browser

System Management and Default Settings

It is recommended that you install your camera with the CD that comes with the package and use accompanying TRENDnetVIEW Pro software for Windows computers. If you do not have the CD with you, please go to <http://www.trendnet.com/support> and enter the model number and download the software.

If you didn't go through the CD installation wizard or you have reset the camera, your camera has following settings:

Management IP :	192.168.10.30 or a dynamic assigned address if you connect the camera to your existing network
Administrator name :	admin
Administrator password :	admin

If you want to access your camera directly instead of using software, you can follow the steps specified in this chapter to login to your camera. A web browser plug-in must be installed to view live image.

Logging-in to the Camera

1. Open the web browser on your computer. In the address bar, enter the IP address you setup through the setup CD or 192.168.10.30. (If you have a DHCP server on your network, the IP address will be assigned dynamically. For example, if you have a home gateway on your network and you plug-in the camera on the same network, you can find the camera's IP address on your home gateway.), and then press **Enter**.



2. Enter the user name, **admin**, and the password you setup through the setup CD or the default password, **admin**, and then click **OK**.

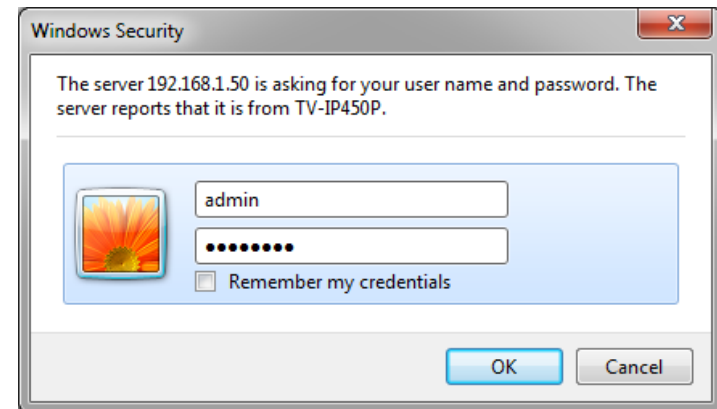

If the camera was not setup through the CD and you are accessing it the first time, you will be prompted to change password automatically.

- The camera management page will detect if you installed the camera video streaming plug-in or not. Click the link to download the plug-in from the camera.

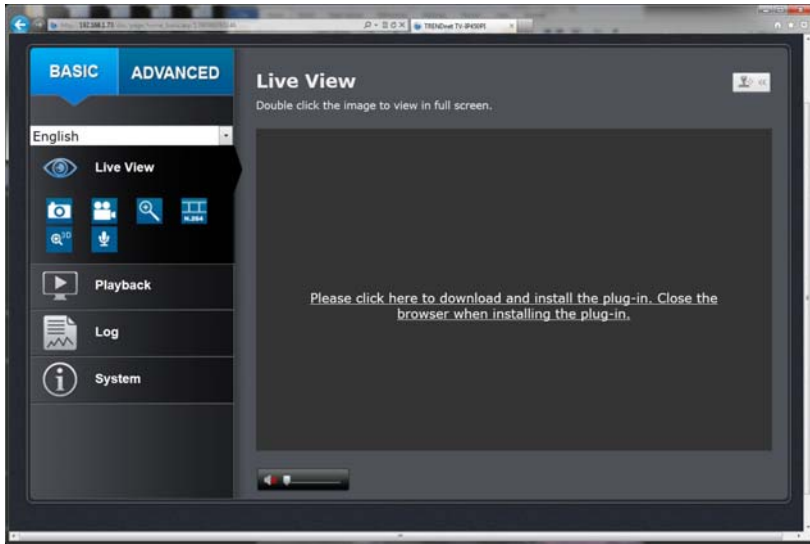

Permission request depends on the Internet security settings of your computer. Click **Run** to install the plug-in.

Note: for Mac systems, the plug-in file is stored on the CD or you can download the latest version from <http://www.trendnet.com/downloads/camera/mac/WebComponents.zip>

- Click **Next** to install the plug-in.

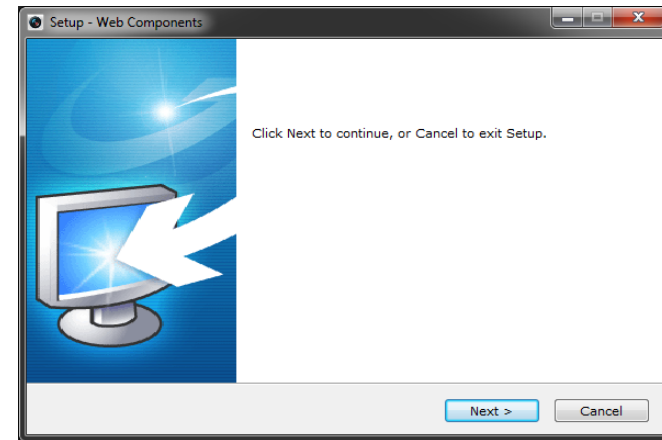

- Click **Finish** to finish the installation.

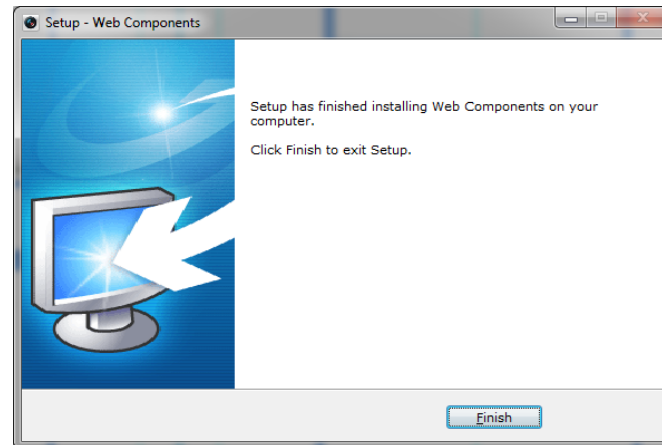

- Open the browser and login again. **Allow** the plug-in from TRENDnet if prompted. The Live View page will show and begin streaming video.

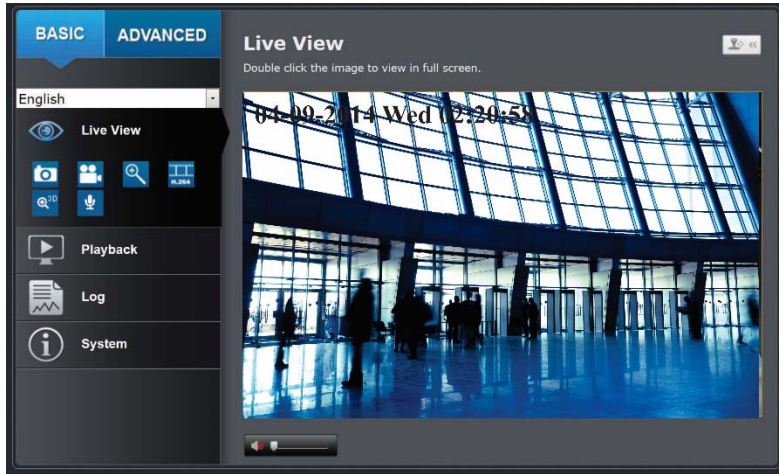





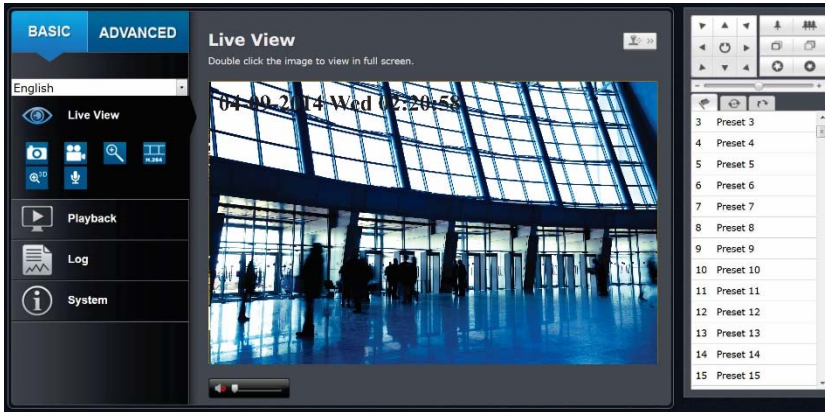

Basic Settings

Live View

After you log-in into the camera management page, you'll see the Live View page.



Multi-Language	Change your preferred language anytime
Snapshot	Click this icon to take a video snapshot
Zoom	Click once to enable zoom. Then, click and drag the area on the picture to zoom in. Click once on picture for 100% zoom. Click the icon again to disable zoom. The zoom function works in full screen mode as well
Recording	Click once to start recording. Click it again to stop recording. The status bar will indicate if it is in recording state or not
Video Stream	The camera has two video streams: H.264 and MJPEG. Switch to view the different video streams by clicking this icon
3D Zoom	Click the position of the live video, the corresponding position will be moved to the center of the live feed. Click and hold the mouse for a desire portion of the live image, then that position will be moved to the center of the live feed
2-way Audio	Click to enable 2-way audio
Full Screen Mode	Click the picture to view in full screen mode. Double click again or press escape key on your keyboard to exit full screen mode

Status Bar	The status bar shows the status you are at, including enabled the zoom, recording video, and successfully taking a snapshot
	The icon expands the PTZ control panel
	<p>Pan / Tilt / Zoom control panel</p> <p> Zoom in / out</p> <p> Focus close / far</p> <p> Iris open / close</p> <p> Speed of pan/tilt movement</p>
Presets	Use the presets panel to move to previously saved locations



Presets

Configure a Preset position

A preset is a predefined image position. For the defined preset, you can click the Call button to quickly view the desired image position.

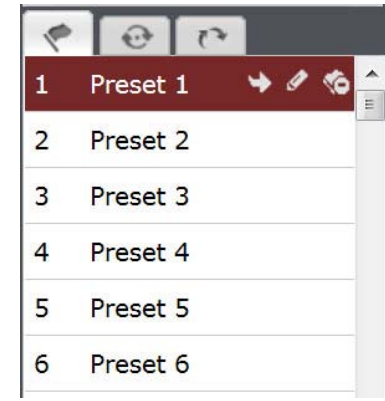
1. In the PTZ control panel, select a preset number from the preset list.



2. Use the PTZ control buttons to move the lens to the desired position.
 - Pan the speed dome to the right or left.
 - Tilt the speed dome up or down.
 - Zoom in or out.
 - Refocus the lens.
3. Click  to finish the setting of the current preset.
4. You can click  to delete the preset. You can configure up to 256 presets.

Calling a Preset position

In the PTZ control panel, select a defined preset from the list and click  to call the preset.

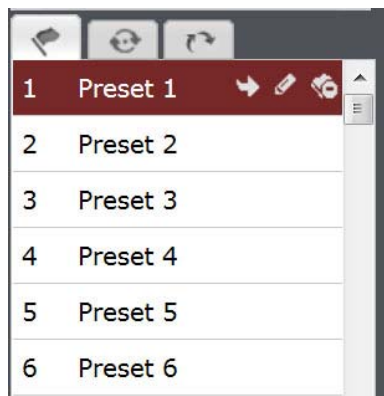

The following presets are predefined with special commands. You can only call them but not configure them. For instance, preset 99 is "Start auto scan". If you call preset 99, the speed dome starts auto scan function.

Special Preset	Function	Special Preset	Function
33	Auto flip	93	Set limit stops manually
34	Back to initial position	94	Remote reboot
35	Call patrol 1	96	Stop a scan
36	Call patrol 2	97	Start random scan
37	Call patrol 3	98	Start frame scan
38	Call patrol 4	99	Start auto scan
39	IR cut filter in	100	Start tilt scan
40	IR cut filter out	101	Start panorama scan
41	Call pattern 1	102	Call patrol 5

42	Call pattern 2	103	Call patrol 6
43	Call pattern 3	104	Call patrol 7
44	Call pattern 4	105	Call patrol 8
45	One-touch patrol		
92	Start to set limit stops		

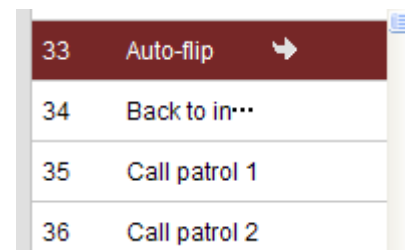



Note: When you call preset 45 (one-touch patrol), the speed dome patrols from presets 1 to 32. Before you enable this function, please set presets 1 to 32 first.

Patrols

A patrol is a memorized series of preset functions. It can be configured and called on the patrol settings interface. There are up to 8 patrol available for customization. A patrol can be configured with 32 presets.

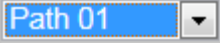
Configure a Patrol route

1. In the PTZ control panel, click  to enter the patrol settings interface.
2. Select a patrol number from .
- Click  to add a preset to a patrol path.

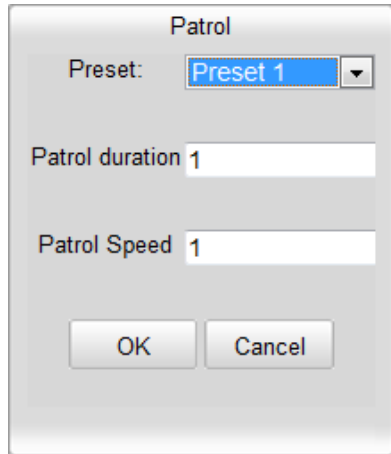



3. Configure the preset number, patrol time and patrol speed.

Name	Description
Patrol Time	This is the duration the camera stays on one patrol point. The speed dome moves to another patrol point after the patrol time.
Patrol Speed	This is the speed that the camera moves in between patrol points.

4. Click  to save a preset into the patrol.



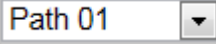



5. Repeat the steps from 3 to 5 to add more presets.
6. Click  to save all the patrol settings.

Calling a Patrol route

In the PTZ control panel, select a defined patrol from  and click  to call the patrol.



Buttons on the Patrol interface:

Buttons	Description
	Save a patrol
	Call a patrol
	Stop a patrol
	Add a preset to a patrol path
	Modify a preset
	Delete a preset
	Delete all the presets in the selected patrol path

Pattern

A pattern is a memorized series of pan, tilt, zoom, and preset functions. A pattern can be called in the pattern settings interface. There are up to 4 patterns available for customization.

Configure a Pattern

1. In the PTZ control panel, click  to enter the pattern settings interface.
2. Select a pattern number from the list as shown in **Error! Reference source not found.**

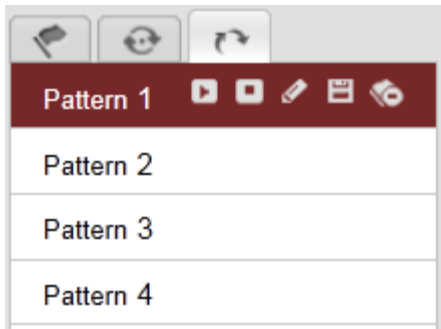









Figure 1-1 Patterns Settings Interface

3. Click  to enable recording the panning, tilting and zooming actions.
4. Use the PTZ control buttons to move the lens to the desired position after the information of **PROGRAM PATTERN REMAINNING MENORY (%)**.
 - Pan the speed dome to the right or left.
 - Tilt the speed dome up or down.
 - Zoom in or out.
 - Refocus the lens.

5. Click  to save the pattern settings.

Buttons on the Patterns interface:

Buttons	Description
	Start recording a pattern.
	Stop recording a pattern.
	Call the current pattern.
	Stop the current pattern.
	Delete the current pattern.

- These 4 patterns can be operated separately and with no priority level.
- When configuring and calling the pattern, proportional pan is valid; the limit stops and auto flip will be invalid; and the 3D positioning operation is not supported.

Playback

You can playback the video recording on the network storage and download the video clip and snapshots to your local computer.

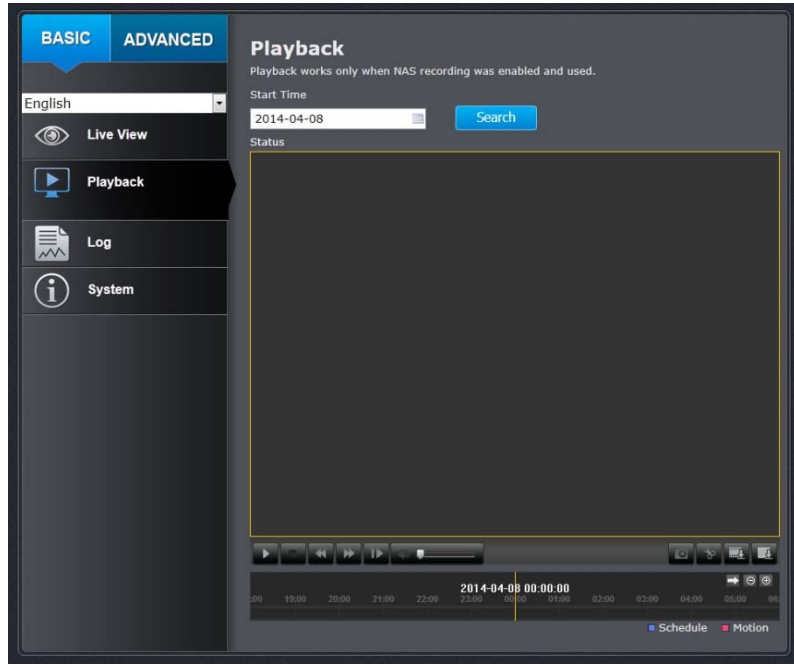

Search for video recordings

Click the date selection, and then choose a date for the date range of your recording. Click Search to start searching.

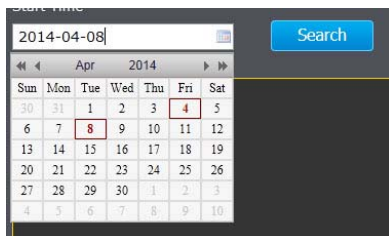

Time line

There is a playback head in the center of the time line represented by a yellow vertical line. To look for a specific video recording, move the time line by clicking and dragging it. If the recording is short, zoom in by clicking button. Click to zoom out the time scale. If you know the exact time of the day you are looking for, click then enter the time you want to playback.

Different types of recordings are identified differently. The scheduled recordings are marked in blue, and the recordings triggered by motion detection are marked in red.

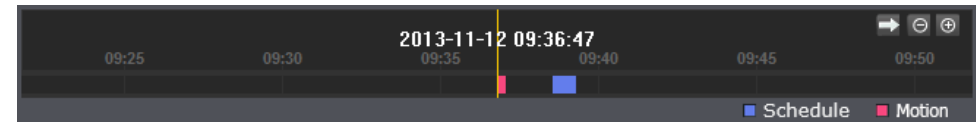

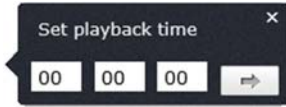
	Click and drag the time line to move your time manually
	Click this button to zoom in the scale
	Click this button to zoom out of the scale
	Click this button to specify a specific time of the day.  then click to confirm selection and then click X to close this dialog box.

Play video

Use playback controls to play back the video recordings.

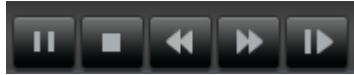

	Click this button to play the video
	Click this button to pause video playback
	Click this button to stop playback
	Click this button to increase playback speed*
	Click this button to decrease playback speed*
	Click to playback video frame by frame. Click again for the next frame.
	*There are 5 steps of playback speeds. You can choose from 1/4, 1/2, 1, 2, and 4 times of original speed.

Take Images from a video playback

You can take snapshots from playback video or make new video clips from the video you are playing back.



	Click this button to enable zoom. Then click and drag on the video to define the area you want to zoom in. Click again to get back to 100% zoom. Double click to show video in full screen and press ESC on keyboard to exit full screen mode
	Click this button to disable zoom

	Click this button to take a snapshot of current playback
	Click this button to start clipping a video from playback
	Click this button to stop clipping a video from playback

Download sections of a video

To save complete video sections or snapshots, you can download the files directly.



	Click this button to download video sections
--	--

No.	File Name	Start Time	End Time	File Size	Progress
<input checked="" type="checkbox"/>	1 ch01_080000000000000401	2013-11-06 07:26:02	2013-11-06 07:26:22	2 MB	Downloaded
<input type="checkbox"/>	2 ch01_080000000000000501	2013-11-06 07:37:00	2013-11-06 07:37:20	1 MB	

[Download](#)

Total 2 Items First Page Prev Page 1/1 Next Page Last Page

Download snapshots



Click this button to download snapshots

No.	File Name	File Date	File Size	Progress
1	ch00_08000000000301901	2013-11-12 09:28:49	107 KB	
2	ch00_08000000000302001	2013-11-12 09:28:50	65 KB	
3	ch00_08000000000302101	2013-11-12 09:28:51	57 KB	
4	ch00_08000000000302201	2013-11-12 09:28:52	52 KB	
5	ch00_08000000000302301	2013-11-12 09:28:53	52 KB	
6	ch00_08000000000302401	2013-11-12 09:28:54	53 KB	
7	ch00_08000000000302501	2013-11-12 09:28:55	53 KB	
8	ch00_08000000000302601	2013-11-12 09:28:56	53 KB	
9	ch00_08000000000302701	2013-11-12 09:28:57	53 KB	
10	ch00_08000000000302801	2013-11-12 09:36:54	181 KB	
11	ch00_08000000000302901	2013-11-12 09:36:55	58 KB	
12	ch00_08000000000303001	2013-11-12 09:36:56	54 KB	
13	ch00_08000000000303101	2013-11-12 09:36:57	52 KB	
14	ch00_08000000000303201	2013-11-12 09:36:58	52 KB	
15	ch00_08000000000303301	2013-11-12 09:36:59	52 KB	
16	ch00_08000000000303401	2013-11-12 09:37:00	52 KB	
17	ch00_08000000000303501	2013-11-12 09:37:01	52 KB	
18	ch00_08000000000303601	2013-11-12 09:37:02	52 KB	
19	ch00_08000000000303701	2013-11-12 09:39:05	54 KB	
20	ch00_08000000000303801	2013-11-12 09:39:06	55 KB	
21	ch00_08000000000303901	2013-11-12 09:39:07	52 KB	
22	ch00_08000000000304001	2013-11-12 09:39:08	52 KB	
23	ch00_08000000000304101	2013-11-12 09:39:09	53 KB	
24	ch00_08000000000304201	2013-11-12 09:39:10	53 KB	
25	ch00_08000000000304301	2013-11-12 09:39:11	52 KB	
26	ch00_08000000000304401	2013-11-12 09:39:12	53 KB	
27	ch00_08000000000304501	2013-11-12 09:39:13	53 KB	

Total 27 Items [First Page](#) [Prev Page](#) 1/1 [Next Page](#) [Last Page](#)

Select the type of event that triggered the snapshots. Choose the **Start Time** and **End Time**. Then, click **Search** to find the snapshot list. Check the time of the snapshot, and then select the snapshots you want to download, then click **Download**.

Note: Where can I find saved files?

Videos and snapshots captured from Playback will save to your computer.

Log

The log of the TV-IP450P will be saved on the network storage. You can search the relevant records and save to your local computer.

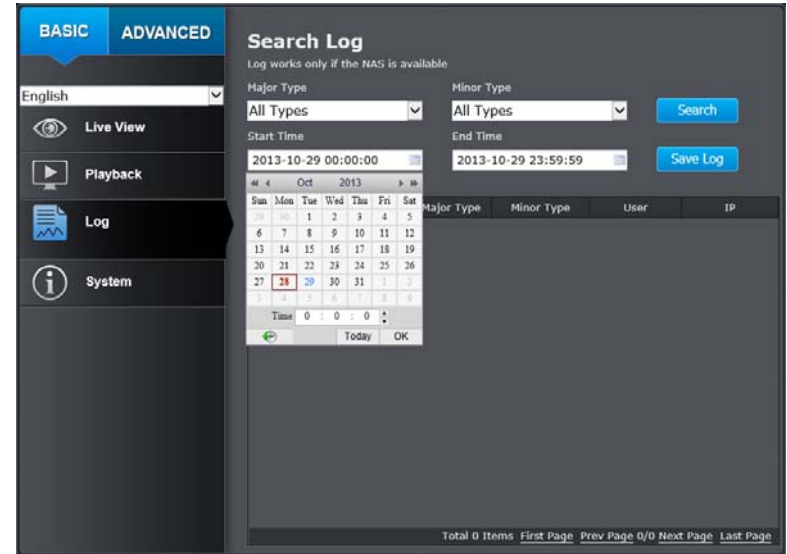

Search for logs

Click the type of log and then the Start Time and End Time. Click Search to start searching.

[Total 129 Items](#) [First Page](#) [Prev Page](#) 1/2 [Next Page](#) [Last Page](#)

Click First Page, Prev Page, Next Page, and Last Page to show the logs. Click Save Log to save the logs to your computer.

System

System Information page shows the camera basic information. Click **System** then click **System Info** to show the page.



Basic Information	
Device Name:	User defined device name
Firmware Version:	Firmware Version
MAC Address:	MAC address of the camera
System Time:	Display the system time
Network Information	
IP Address:	IP address of the camera
Subnet Mask:	Network range of IP address
Default Gateway:	Gateway for the camera
Primary DNS:	Primary DNS server address
Secondary DNS:	Secondary DNS server address

Advanced Settings

System

Device Settings

Setup your camera name and location for easy identification. This camera name will also be recognized by other network camera software as the name of this camera. OSD, On Screen Display, the camera name is setting up here as well.

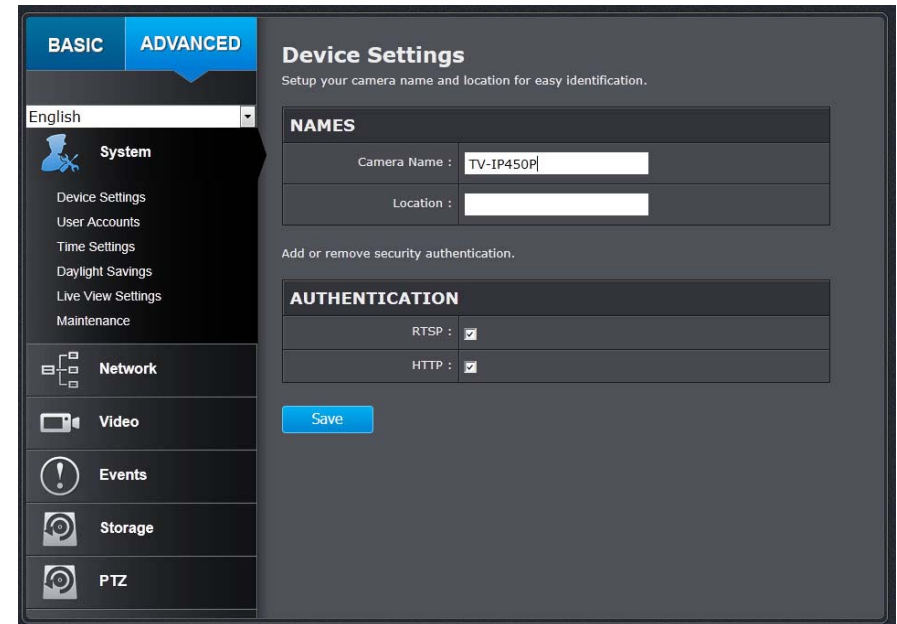

Names	
Camera Name:	Name of the camera. The camera name setup here can be discovered by other network camera

	software and OSD, On Screen Display. The default is the camera's model name:
Location:	Label where you installed this camera
Authentication	
RTSP:	Camera's video stream can be accessed with RTSP, Real Time Streaming Protocol. Only the administrator and users can view this video stream. Un-checking this box will allow everyone access to this video stream without authentication. Default: checked.
HTTP:	Camera can be accessed via password protected web management interface. Un-checking this box will allow anyone to access this camera and change its settings.

User Accounts

You can setup up to 16 user accounts to access the camera's video stream with a web browser or real time video stream (RTSP). Only one administrator account can be setup to configure the camera and cannot be deleted.

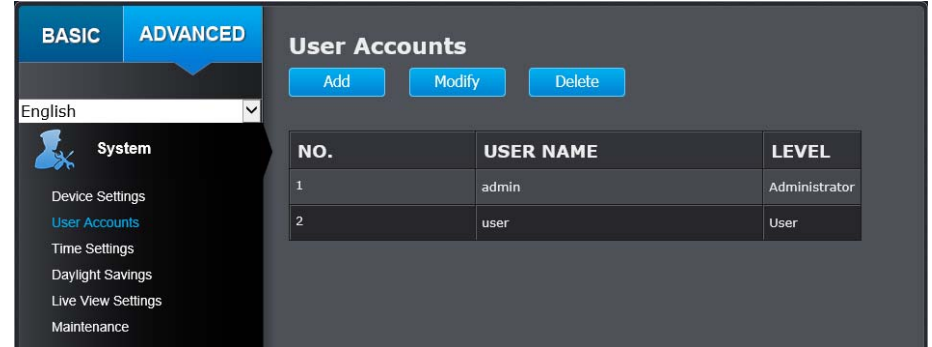

User Accounts	
Add:	Click Add button to add one user account
Modify:	To change a user's name and password, highlight the user by clicking on it. Then, click Modify button. You can change the user's name and password. You can also change the administrator's password here. But, the administrator's name is fixed, you cannot change that.
	Click OK to save the changes.

Time Settings

The accuracy of the system clock is important for scheduling and accurate logging. You can synchronize the system time with your computer, or automatically check the time accuracy with a network time server (NTP server).

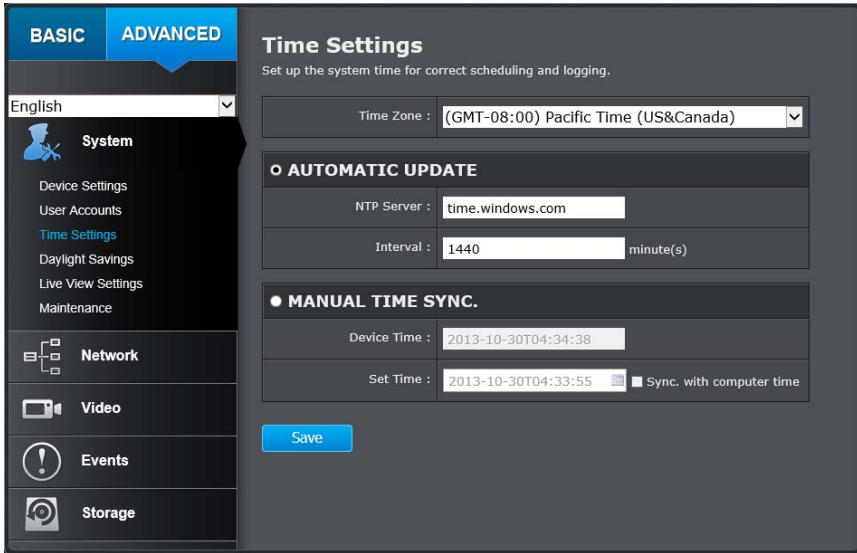

Automatic Update	
NTP Server:	Specify a time server (NTP server) to synchronize with. (e.g. pool.ntp.org)
Interval:	The time interval that the camera will synchronize the time with NTP server. Default: 1440 minutes (24 hours).
Click Save to save the changes	

Manual Time Sync.	
Device Time:	The system time of this camera.

Set Time:	Click the calendar icon and manually select the date. Check the Sync. with computer time to copy the time from your computer.
Click Save to save the changes	

Daylight Savings

Setup daylight settings for the camera.

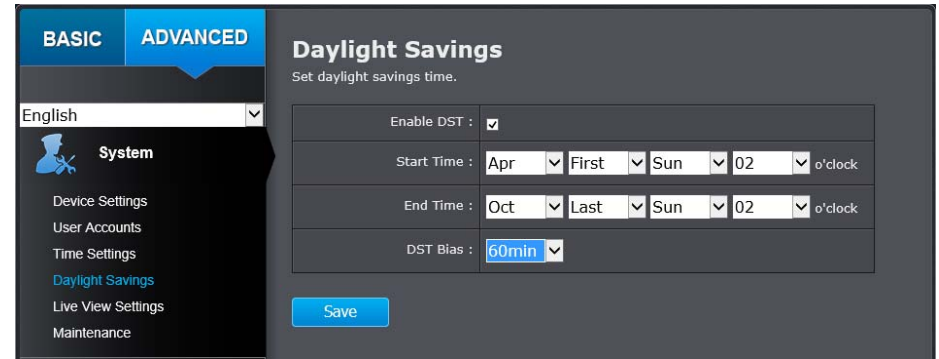

Daylight Saving	
Enable DST:	Check this box if your time zone has daylight savings
Start Time:	Enter the date that daylight savings starts
End Time:	Enter the date that daylight savings ends
DST Bias:	Enter how much time the daylight saving adjusted by daylight savings
Click Save to save the changes	

Live View Settings

Setup daylight settings for system time.

Live View Settings

Live View Parameters

Live View Buffer Low Medium High

Record File Settings

Record File Size 256M 512M 1G

Save record files to

Save downloaded files to

Picture and Clip Settings

Save snapshots in live view to

Save snapshots when playback to

Save clips to

Live View Parameters	
Live View Buffer:	Configure the buffer size for live view video stream. With low buffer size setting, you can get real-time video stream, but the video may be stop and go if the network is congested. With high buffer setting, you can have smooth video streaming, but the video is delayed from the time happening. Medium size can have moderate video stream smoothness and time delay.
Record File Settings	

Record File Size:	This size of live view video recording. You can choose 256MB, 512MB, or 1GB a file. Smaller file size is good for many short recordings.
Save Record Files to:	By default, files will be saved under your user name, and under the TRENDnet/RecordFiles. Click Browse and choose a new destination if you want to save the file somewhere else.
Save Download Files to:	By default, files will be saved under your user name, and under the TRENDnet/DownloadFiles. Click Browse and choose a new destination if you want to save the file somewhere else.
Picture and Clip Settings	
Save Snapshots in live view to:	By default, files will be saved under your user name, and under the TRENDnet/CaptureFiles. Click Browse and choose a new destination if you want to save the file somewhere else.
Save snapshots when playback to:	By default, files will be saved under your user name, and under the TRENDnet/PlaybackPics. Click Browse and choose a new destination if you want to save the file somewhere else.
Save Clips to:	By default, files will be saved under your user name, and under the TRENDnet/PlaybackFiles. Click Browse and choose a new destination if you want to save the file somewhere else.
Click Save to save the changes	

Maintenance

You can do the camera system maintenance on this page.

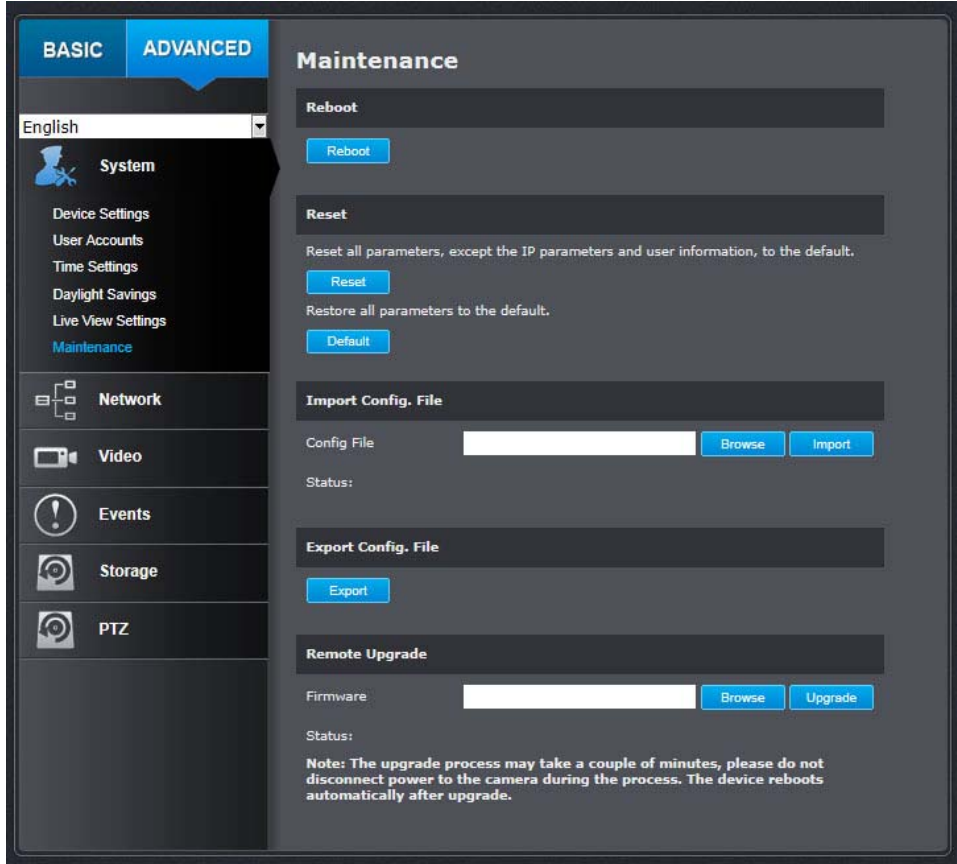

Reboot	
Reboot:	Click this button to reboot this camera.
Reset	
Reset:	Reset all camera parameters except the IP parameters and user information.

Default:	Load complete factory default settings to the camera.
Import Config. File	
Config. File:	To load previously saved configurations, click Browse to find the configuration file and then click Import .
Status:	Shows the status in loading configuration file.
Export Config. File	
Export:	Click Export to download configuration file. The file will be downloaded to the Download folder by default.
Remote Upgrade	
Firmware:	Click Browse to find the latest firmware and then click Upgrade* .
Status:	Shows the status in firmware upgrade.
Click Save to save the changes	

* TRENDnet may periodically release firmware upgrades that might add features or fix problems associated with your TRENDnet model and version. To find out if there is a firmware upgrade available for your device, please check your TRENDnet model and version using the link.

<http://www.trendnet.com/downloads/>

Network Settings

TCP/IP

Setup your basic IPv4 and IPv6 network settings on this page.

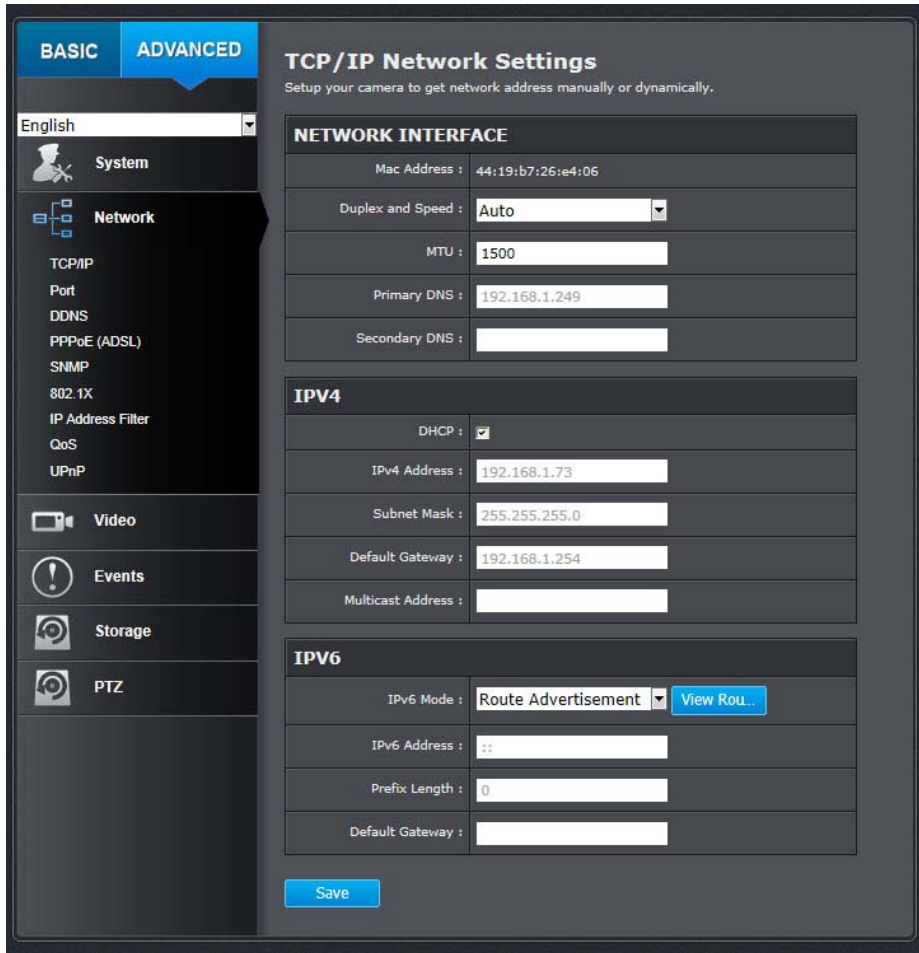

Network interface	
MAC Address:	Click this button to reboot this camera.
Duplex and Speed:	Choose one of the Ethernet duplex and speed to match your network. Default: auto.
MTU:	Maximum transmission unit. The maximum byte size Ethernet data field.
Primary DNS:	Enter your first IPv4 or IPv6 DNS server address
Secondary DNS:	Enter your second IPv4 or IPv6 DNS server address
IPv4	
DHCP:	Check this box if the IP address is assigned by DHCP server.
IPv4 Address:	Load complete factory default to the camera.
Subnet Mask:	Network range of the subnet
Default Gateway:	The default route going further from camera IPv4 subnet.
Multicast Address:	Multicast address for video streaming.
IPv6	
IPv6 Mode:	Choose Manual, DHCP, or Route Advertisement. Click View Route Advertisement to find a route advertisement.
IPv6 Address:	IPv6 address of the camera.
Prefix Length:	Length of network prefix
Default Gateway:	The default route going further from camera IPv6 subnet.
Click Save to save the changes	

Port

You can change the service ports number of the camera or disable RTSP or HTTPS services.

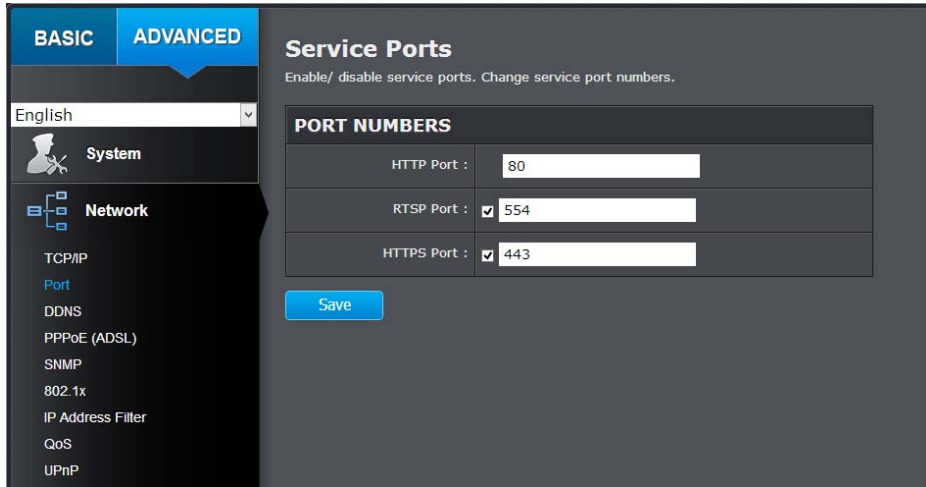

Port Numbers	
HTTP Port:	The default web access port. You can change the port number. However, you cannot disable the web service. The default port number is 80.
RTSP Port:	The Real-Time Streaming Protocol port for video streaming. You can change the port number or disable the service by uncheck the box. The default port number is 554.
HTTPS Port:	The secured web service port. You can change the port number, or you can disable the service by uncheck the box. The default port number is 443.
Click Save to save the changes	

DDNS

Dynamic Domain Name Service, DDNS, allows you to find your camera from the Internet with an easy to remember domain name.

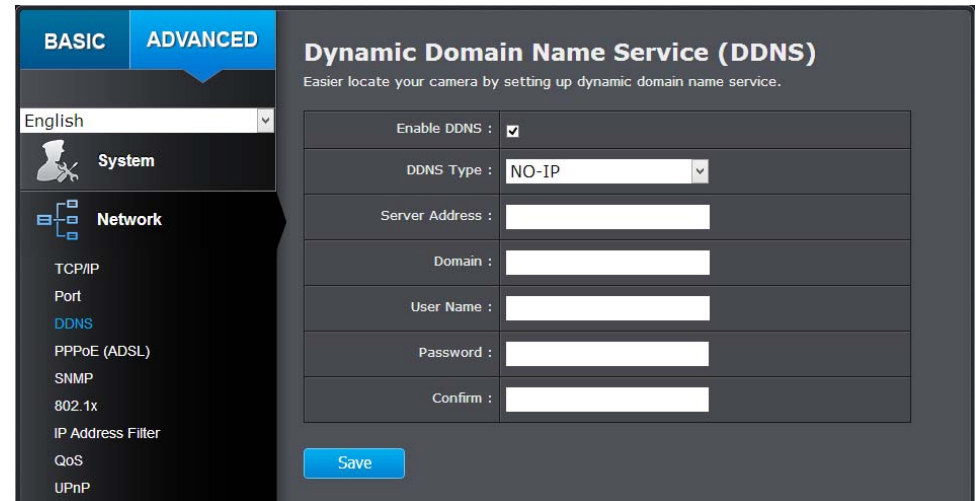

DDNS	
Enable DDNS:	Check this box to enable DDNS Service.
DDNS Type:	Select a DDNS service provider.
Server Address:	Enter the DDNS server address.
Domain:	Enter your registered domain name on selected DDNS service.
User Name:	Enter the account name.
Password:	Enter the password.
Click Save to save the changes	

PPPoE

Setup PPPoE (ADSL) connection to connect your camera with your ISP, Internet Service Provider.

PPPoE (ADSL)	
Enable PPPoE:	Check this box to enable PPPoE connection.
Dynamic IP:	The IP address provided by ISP
User Name:	Enter the account name.
Password:	Enter the password.
Confirm:	Enter the password again.
Click Save to save the changes	

SNMP

SNMP Settings allows you to assign the contact details, location, community name and trap settings for SNMP. This is a networking management protocol used to monitor network-attached devices. SNMP allows messages (called protocol data units) to be sent to various parts of a network. Upon receiving these messages, SNMP compatible devices (called agents) return data stored in their Management Information Bases.

SNMP V1/V2	
Enable SNMPv1:	Check this box to enable SNMP v1 management.
Enable SNMPv2c:	Check this box to enable SNMP v2c management.
Read SNMP Community:	Specify the password for access the SNMP community for read only access
Write SNMP Community:	Specify the password for access to the SNMP community with read/write access
Trap Address:	Specify the IP address for the SNMP trap community
Trap Port:	Specify the port number for the SNMP trap community
Trap Community:	Specify the name of SNMP trap community
SNMP V3	
Enable SNMPv3:	Check this box to enable SNMP v3 management.
Read User Name:	SNMP v3 member user name
Security Level:	Choose one of the security levels. <div style="border: 1px solid black; padding: 2px;"> Authentication and Privacy Authentication only Privacy only </div>
Authentication Algorithm:	Choose the authentication method to verify the source of information: MD5 or SHA.
Authentication Password:	Specify the authentication password between 8 to 32 letters.
Private-key Algorithm:	Choose the privacy key to encrypt SNMP messages: DES or AES.
Private-key Password:	Specify the privacy key between 8 to 32 letters.
Write User Name:	SNMP v3 manager user name
Security Level:	Choose one of the security levels.
Authentication Algorithm:	Choose the authentication method to verify the source of information: MD5 or SHA.
Authentication Password:	Specify the authentication password between 8 to 32 letters.

Private-key Algorithm:	Choose the privacy key to encrypt SNMP messages: DES or AES.
Private-key Password:	Specify the privacy key between 8 to 32 letters.
SNMP Other Settings	
SNMP Port:	SNMP service port number.
Click Save to save the changes	

802.1X

Setup 802.1X for remote authentication service.

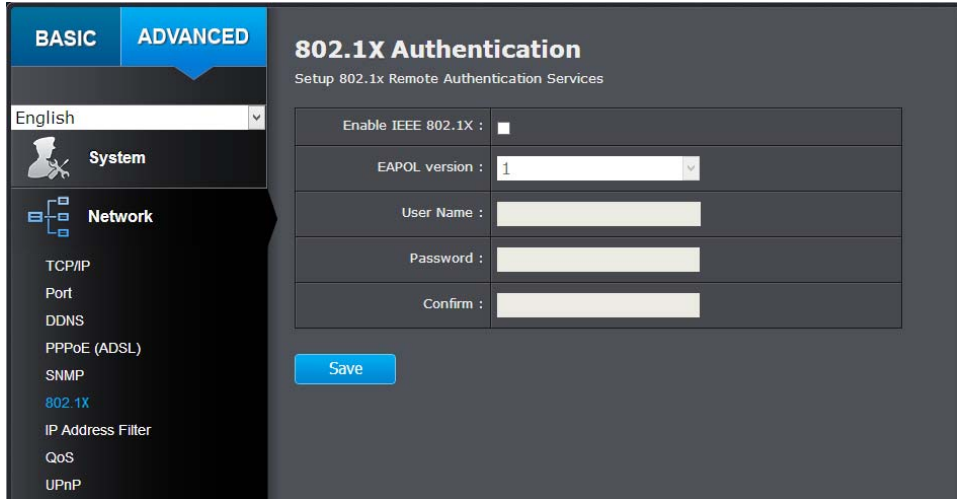

802.1X Authentication	
Enable IEEE 802.1X:	Check this box to enable 802.1X authentication service.
EAPOL version:	Extensible Authentication Protocol (EAP) over LAN (EAPoL). Choose version 1 or 2. This version number must matches to your 802.1X service EAPOL version.
User Name:	Enter the account name.
Password:	Enter the password.
Confirm:	Enter the password again.
Click Save to save the changes	

IP Address Filter

Set up a list of clients allow only the clients on the list to access this camera or to reject clients on the list from access this camera.

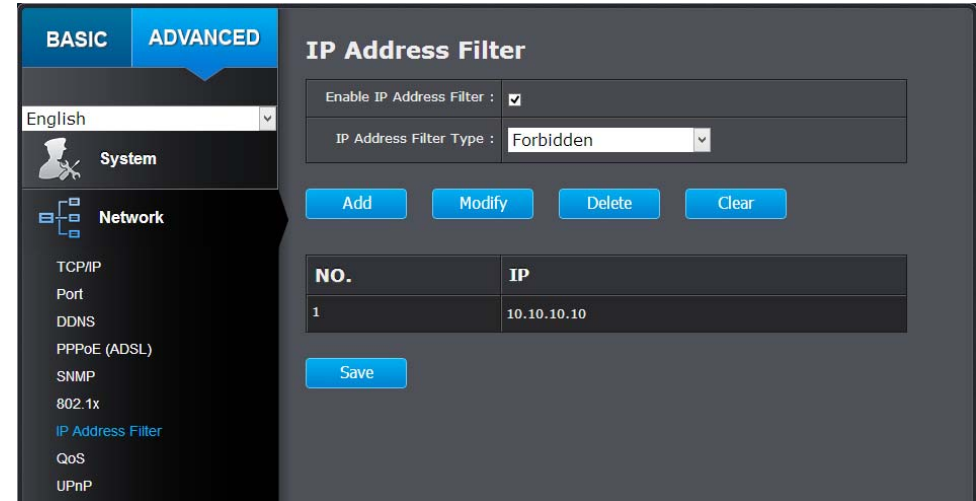

IP Address Filter	
Enable IP Address Filter:	Check this box to enable IP address filtering service.
IP Address Filter Type:	Choose Forbidden to ban the listed IP addresses or Allowed to allow listed host to access this camera.
Add:	Click Add to add a user account
Modify:	To modify an entry on the list, highlight the entry by clicking on it. Then, click the Modify button.  Enter the IP address then click OK .
Delete:	To delete an entry on the list, highlight the entry by clicking on it. Then, click Delete .
Click Save to save the changes	

QoS, Quality of Service

Setup traffic prioritization to help smooth out the video stream. You can set the Differentiated Services Code Point (DSCP) bits on outgoing data streams. The QoS capable network device will forward different data in different priorities. The meaning of the value is different in different DiffServ domains. Consult your network manager for the setup details.

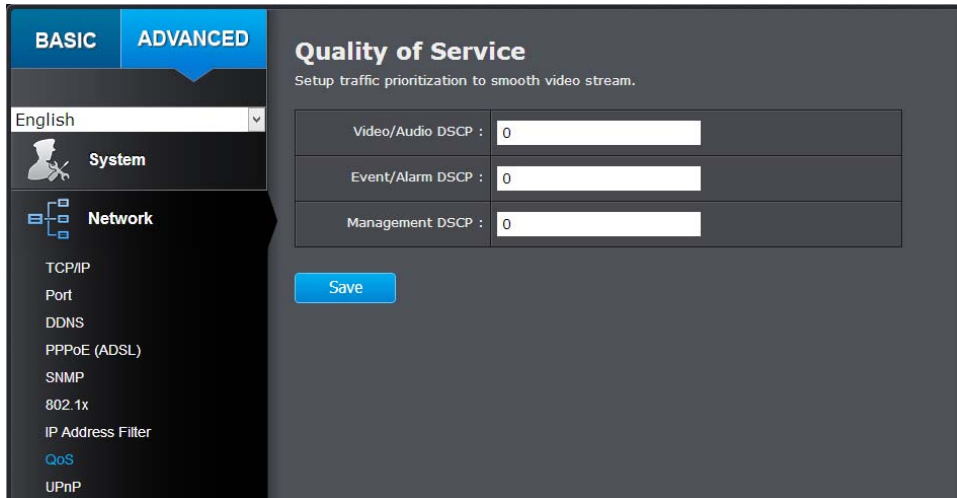

QoS	
Video/Audio DSCP:	Enter Video/Audio DSCP. Default: 0.
Event/Alarm DSCP:	Enter Event/Alarm DSCP. Default: 0.
Management DSCP:	Enter Management DSCP. Default: 0.
Click Save to save the changes	

UPnP

Universal Plug-and-Play is a device discovery protocol set. It allows your camera to easily be found, for example, on a Windows operation system.

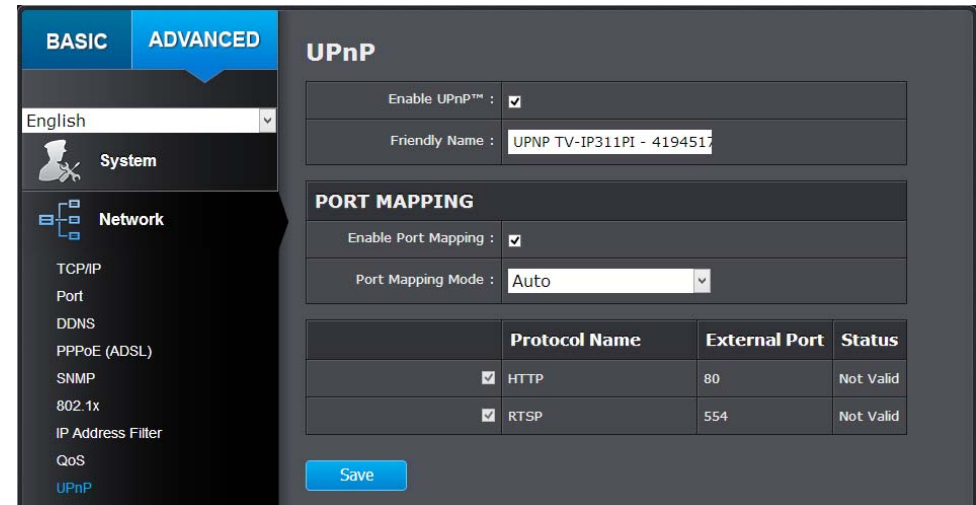

UPnP	
Enable UPnP:	Check this box to enable UPnP connection.
Friendly Name:	The name that will be appeared when searched.
Port Mapping	
Enable Port Mapping:	Check this box to enable UPnP connection.
Port Mapping Mode:	Choose Manual or Auto port mapping.
External Port:	Choose the port number for mapping.
Click Save to save the changes	

Video Settings

Video Format

Adjust the format of video.

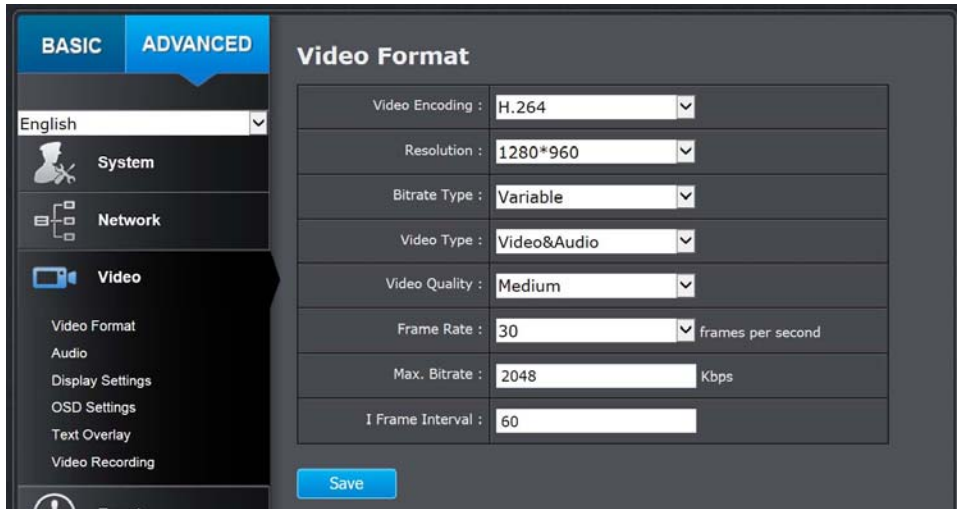

Video Format									
Video Encoding:	Choose the video stream you want to modify. H.264 and MJPEG videos are always streaming and can be configured separately.								
Resolution:	<table border="1"> <thead> <tr> <th>H.264</th> <th>MJPEG</th> </tr> </thead> <tbody> <tr> <td>1280*720P</td> <td>352*240</td> </tr> <tr> <td>1280*960</td> <td>704*480</td> </tr> <tr> <td></td> <td>320*240</td> </tr> </tbody> </table>	H.264	MJPEG	1280*720P	352*240	1280*960	704*480		320*240
H.264	MJPEG								
1280*720P	352*240								
1280*960	704*480								
	320*240								
Bitrate Type:	Choose between variable bit rate or constant bit rate for video compression. The default is variable rate. Variable Constant								
Video Quality:	Choose the video quality. The default is medium quality.								

	Lowest Lower Low Medium Higher Highest
Frame Rate:	Choose the capturing frame rate. The default value is 30 frames per second. Reduce the frame rate to reduce the capture file size. 30 1/16 1/8 1/4 1/2 1 2 4 6 8 10 12 16 20 15 18 22
Max. Bitrate:	Choose the maximum video sampling bit rate. Default: 4096
Frame Interval	An I Frame is a frame that records a complete picture. Frames between I frames, (P frame or B frame) only records the image differences between two frames. Choose the I Frame Interval here. The default is 60.
Click Save to save the changes	

Audio

Adjust the audio settings for the camera.

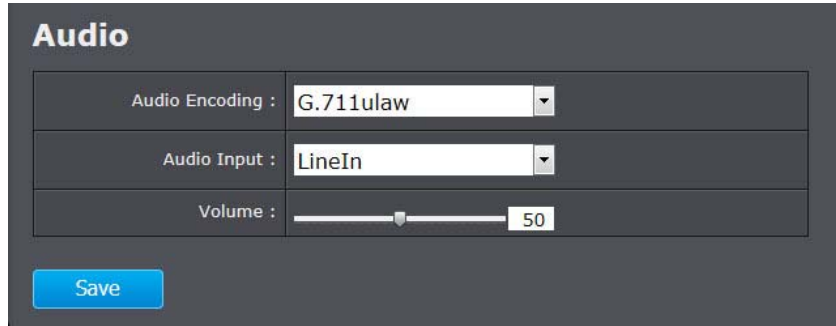

Audio	
Audio Encoding:	G.711ulaw, G.711alaw, MP2L2 and G.726 selectable.
Audio Input:	Select LineIn or MicIn to adjust volume.
Input Volume:	Slid the bar to turn up/down the volume. The value ranges from 0 to 100.
Click Save to save the changes	

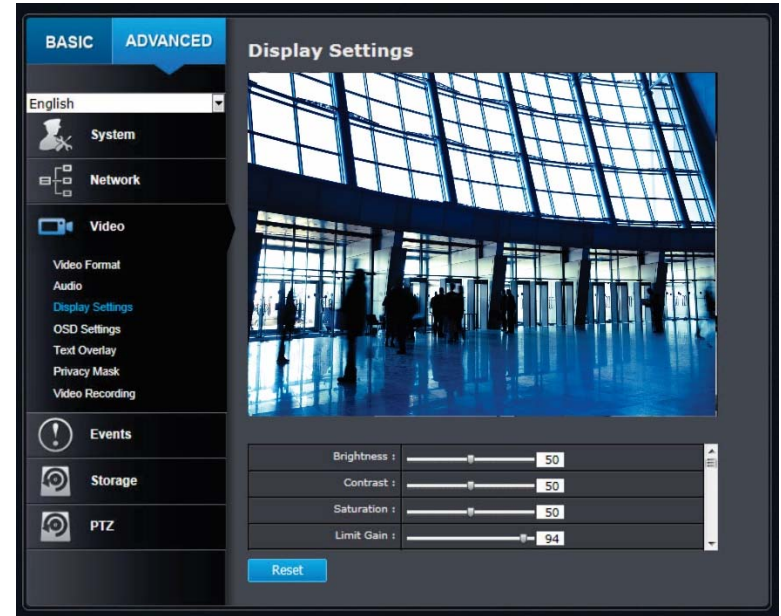

Display Settings

Adjust video image quality, lightness, and color settings here.



Display Settings	
Brightness:	Use the slider or enter a number (0-100) to adjust the image brightness. Default: 50
Contrast:	Use the slider or enter a number (0-100) to adjust the image contrast. Default: 50
Saturation:	Use the slider or enter a number (0-100) to adjust the color saturation. The greater number means the color will be more saturated. Default: 50
Limit Gain:	Use the slider or enter a number (0-100) to adjust the color shade. Default: 50
Sharpness:	Use the slider or enter a number (0-100) to adjust the image sharpness. Default: 50

Focus Mode :	Semi-auto
Minimum Focusing :	6m
Exposure Mode :	Auto
Video Standard :	60hz
Day/Night Switch :	Auto
Sensitivity :	Normal
Mirror :	Horizontal/Vertical
Slow Shutter :	<input type="checkbox"/>
Slow Shutter Level :	Low
D-WDR :	Enabled
D-WDR Level :	<input type="range" value="20"/>
Lens Initialization :	<input type="checkbox"/>
BLC :	Close
White Balance :	Auto
Digital Noise Reduction :	Normal Mode
Noise Reduction Level :	<input type="range" value="100"/>
Zoom Limit :	20
HLC :	Disable

Display Settings	
<p>Focus Mode:</p> <div style="border: 1px solid black; padding: 2px;"> <p>Semi-auto</p> <p>Auto</p> <p>Manual</p> <p>Semi-auto</p> <p>Auto</p> </div>	<p>Auto focus: allows the camera to focus automatically at any time.</p> <p>Manual: use the   icon in the live view page to control focus manually.</p> <p>Semi-auto: cameras focuses only once after pan/tilt/zoom.</p>
<p>Minimum Focusing:</p> <div style="border: 1px solid black; padding: 2px;"> <p>6m</p> <p>10cm</p> <p>50cm</p> <p>1m</p> <p>1.5m</p> <p>3m</p> <p>6m</p> <p>INFINITE</p> </div>	<p>This function is used to limit the minimum focus distance. The value can be set to 1.5m, 3m, 6m, 10cm and 50cm.</p>
<p>Exposure Mode:</p> <div style="border: 1px solid black; padding: 2px;"> <p>Auto</p> <p>Manual</p> <p>Auto</p> <p>Iris Priority</p> <p>Shutter Priority</p> </div>	<p>Auto: The iris and shutter values will be adjusted automatically according to the brightness of the environment.</p> <p>Manual: Once selected, you can adjust the Iris and shutter speed from the extended options menu.</p>
<p>Iris</p> <div style="border: 1px solid black; padding: 2px;"> <p>f4.8</p> <p>f1.6</p> <p>f2.0</p> <p>f2.4</p> <p>f2.8</p> <p>f3.4</p> <p>f4.0</p> <p>f4.8</p> <p>f5.6</p> <p>f6.8</p> <p>f9.6</p> <p>f11</p> <p>f14</p> <p>f16</p> <p>f19</p> <p>f22</p> </div>	<p>Iris Priority: The value of iris needs to be adjusted manually. The shutter values will be adjusted automatically according to the brightness of the environment.</p> <p>Shutter Priority: The value of shutter needs to be adjusted manually. The iris values will be adjusted automatically according to the brightness of the environment.</p>

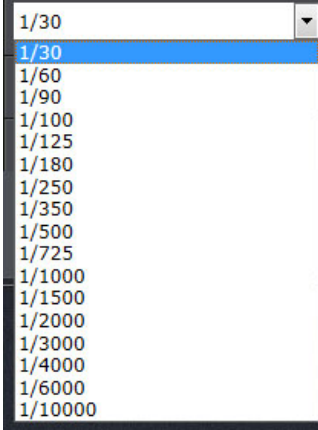
<p>Shutter Speed</p> 	
<p>Video Standard:</p>	<p>This is the base frequency for the video refresh rate. It is recommended to set to the same frequency of your local video standard (NTSC: 60, PAL: 50). Default: 60Hz.</p>
<p>Day/Night Switch:</p>	<p>Choose whether you want the camera to be set to the day mode (color video) or night mode (IR enhanced black/white video). You can manually set it to day mode or night mode, adjust by lighting (Auto), or pre-define schedule.</p> <p>Day: The speed dome displays color image. It is used for normal lighting conditions.</p> <p>Night: The image will be black and white. Night mode can increase the sensitivity in low light conditions.</p> <p>Auto:</p>

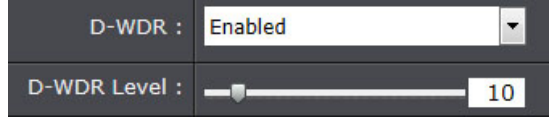
	<p>In Auto mode, the day mode and night mode can switch automatically according to the light condition of environment.</p>
<p>Mirror:</p>	<p>Select from OFF or ON option to set the correct direction of the camera view.</p>
<p>Slow Shutter:</p>	<p>This function can be used in underexposure condition. It lengthens the shutter time to ensure full exposure. The slow shutter value can be set to Low, Normal and High.</p>
<p>D-WDR:</p>	<p>This Digital Wide Dynamic Range feature helps to improve the image quality under limited light source. Higher value brings brighter images.</p> 
<p>Lens Initialization:</p>	<p>The lens operates the movements for initialization when you check the check box.</p>
<p>BLC:</p>	<p>If there's a bright backlight, the subject in front of the backlight appears silhouetted or dark. Enabling BLC (back light compensation) function can correct the exposure of the subject. But the backlight environment is washed out to white.</p>
<p>White Balance:</p>	<p>Auto: The camera retains color balance automatically according to the current color temperature.</p> <p>Manual: In MWB mode, you can adjust the color temperature manually to meet your own demand. Outdoor: You can select this mode when the speed dome is installed in outdoor environment.</p> <p>Indoor: You can select this mode when the speed dome is installed in indoor environment.</p>

	<p>Fluorescent Lamp: You can select this mode when there are fluorescent lamps installed near the speed dome.</p> <p>Sodium Lamp: You can select this mode when there are sodium lamps installed near the speed dome.</p> <p>Auto-Track: White balance is continuously being adjusted in real-time according to the color temperature of the scene illumination.</p>
Digital Noise Reduction:	<p>Enable or disable noise reduction.</p> <p>Noise Reduction Level: Adjust the effect of digital noise reduction. Range: 0-100%, default : 100%</p>
Zoom Limit:	<p>You can set Zoom Limit value to limit the maximum value of zooming. The value can be set to 20, 40, 80, 160 and 320.</p>
HLC:	<p>HLC (High Light Compensation) makes the camera identify and suppress the strong light sources that usually flare across a scene. This makes it possible to see the detail of the image that would normally be hidden.</p>

On Screen Display (OSD) Settings

You can display the camera name and the time the video is shooting on the screen.

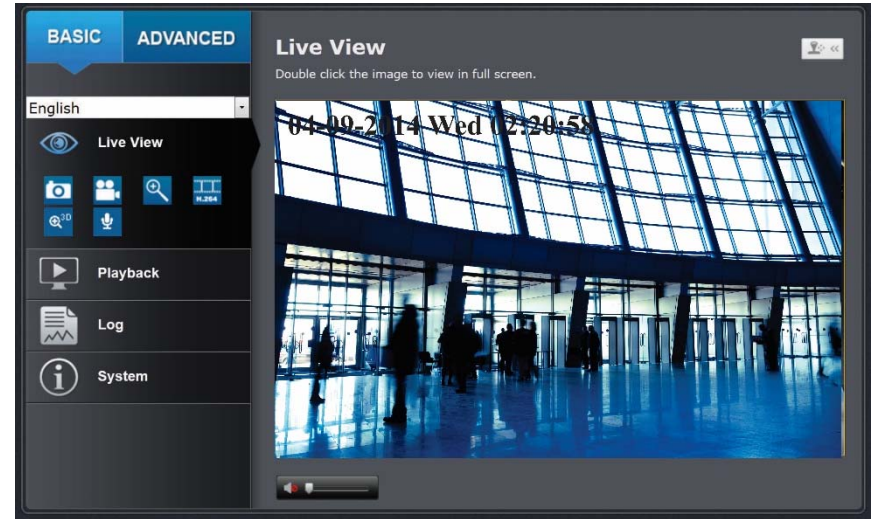

OSD Display	
Display Name:	Check this box to display the product name that was setup in the device settings (refer to page 25 to change the device name.)
Display Date:	Check this box to display system time.
Display Week:	Check this box to display time of the week.
Time Format:	Select 12 or 24 hours' time format.
Data Format:	Select different date format.
Display Mode:	Select transparent/flashing format.
OSD Size:	Select different size format. (Auto, 16*16, 32*32, 48*48, 64*64)
Click Save to save the changes	

Text Overlay

Display extra information on the screen over the image.

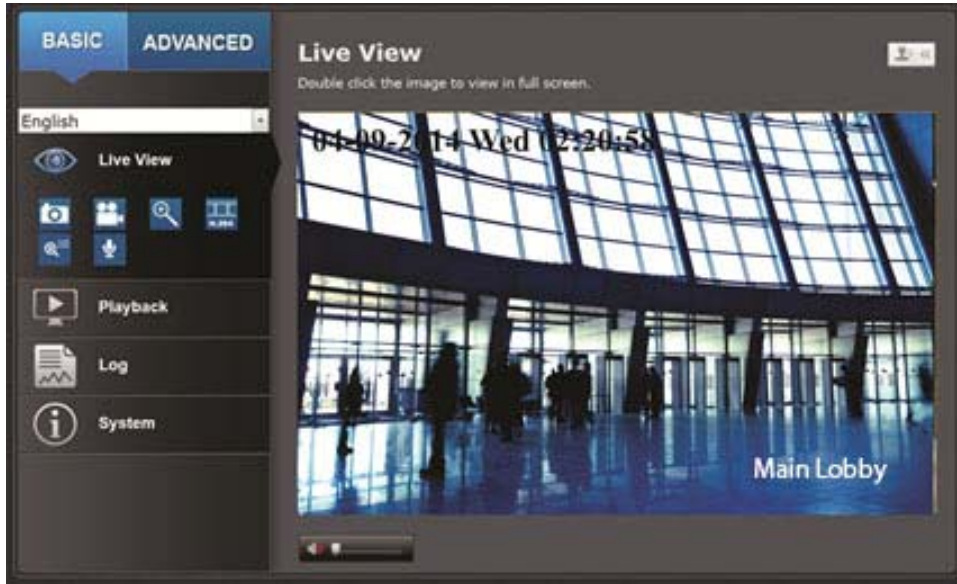

Text Overlay	
Check Box:	Check this box to enable text overlay.
Text Field:	Enter the text you want to display. You can enter your local language if you want. The text field allows maximum 44 English letters or 20 non-English characters.
Click Save to save the changes	

Video Recording

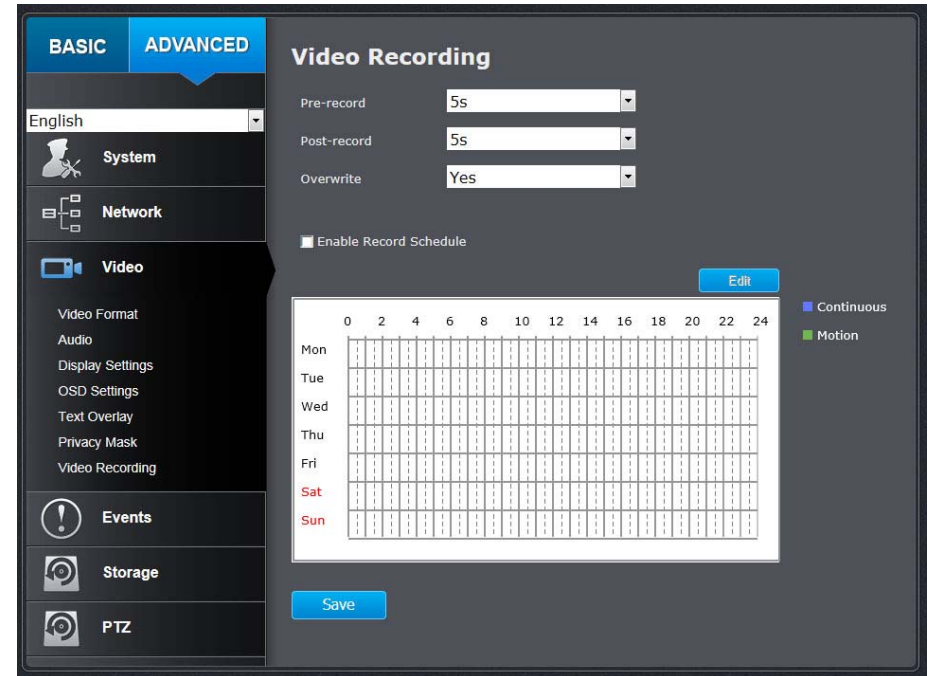

Video Recording	
Pre-record:	Recording time before event.
Post-record:	Recording time after event.
Overwrite:	Select Yes to allow older recordings to be overwritten.
Enable Record Schedule:	Check this box and then click Save to enable video recording.
Edit:	Click Edit to edit the recording schedule.

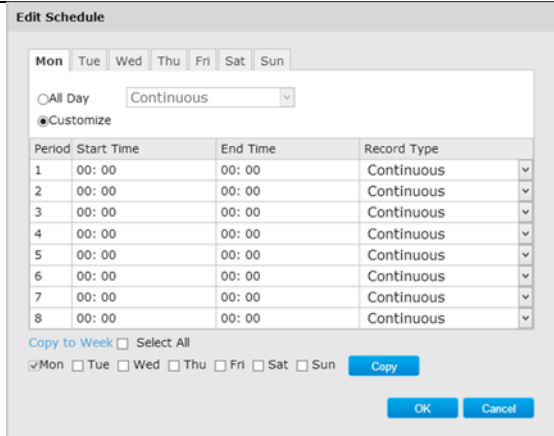

1. Select day of the week you want to edit the schedule.
2. Select **All Day** or **Customized** schedule of the day.
3. Set the time period and the event you want to trigger the video recording **continuous** (always recording) or **motion detection**.
4. Click **Copy to Week** if you want the same daily schedule every day. Or, you can select other day of the week and click **Copy** to copy the schedule of the day to other days.
5. Click another day of the week by clicking on its tab to set the next schedule. Click **OK** when you have finished your settings.

Click **Save** to save the changes

Events

Motion Detection

Set up how the motion detection event will be triggered and what actions will be triggered.

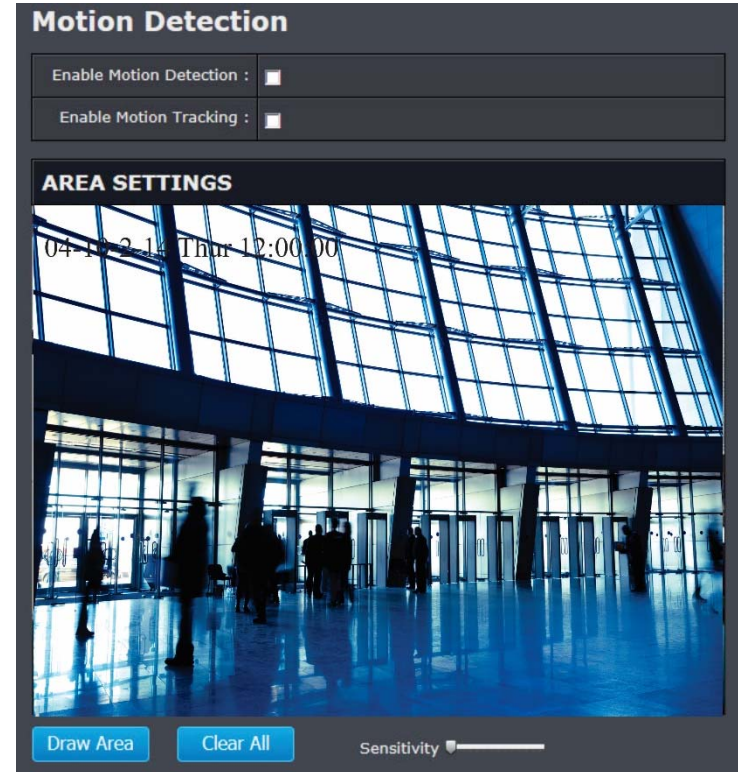

Motion Detection

Enable Motion Detection:	Check this box to enable motion detection. Click Save to save the choice.
Enable Motion Tracking:	Check this box to enable motion tracking. Motion tracking is a dynamic display that shows the current

	status of motion detection. The motion tracking is displayed by a green grid. The grid area represents that the camera detects motion in this area. Click Save to save the choices.
Draw Area:	Click Draw Area button to start drawing. Click and drag on the area you want to set up the motion detection. You can draw up to 8 different areas. Click Stop Drawing to stop drawing motion detection areas. The red grids represent the detection area.
Sensitivity:	Move the slider to adjust detection sensitivity.
Clear All:	Click this button to clear all the set up areas.

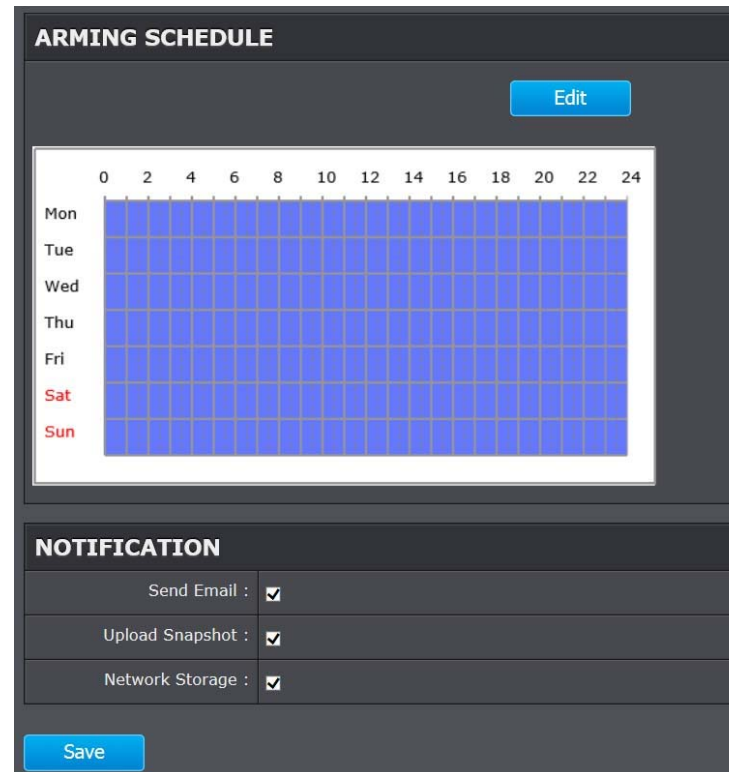

Arming Schedule	
Edit:	Click Edit to define when you want the motion detection works.

1. Select day of the week you want to edit the schedule.
2. Set the time period you want to enable motion detection. (Default is 0-24 hours, all day).
3. Click **Copy to Week** if you want the same daily schedule every day or you can select other day of the week and click **Copy** to copy the schedule of the day to other days.
4. Select another day of the week by clicking on its tab to set next schedule. Click **OK** when you finished your setting.

Notification

- Send Email:** Check this box to send an e-mail notification when motion is detected. Go to Events / Email to setup email account information.
- Upload Snapshot:** Check this box to send snapshots to an FTP server or configured Network Storage when motion is detected. Go to Network Storage or FTP to setup server information

Network Storage: Check this box to record video to network storage when motion is detected. Go to Storage / Network Storage to setup storage information.

Click **Save** to save the changes

Video Tamper

This is to detect if the camera has been tampered with and surveillance is compromised. You can set up tamper proof notifications to alert the system manager to check the camera.

Video Tamper	
Enable Tamper Detection:	Check this box to enable tamper detection. Click Save to save the settings.
Draw Area:	Click Draw Area button to start drawing. Click and drag on the area you want to set up the tamper detection. You can setup only one area for tamper detection. Click Stop Drawing to stop drawing motion detection areas. The gray block represent the detection area.
Sensitivity:	Move the slider to adjust detection sensitivity.
Clear All:	Click this button to clear all the set up areas.
Enable Tamper Detection:	Check this box to enable tamper detection. Click Save to save the settings.

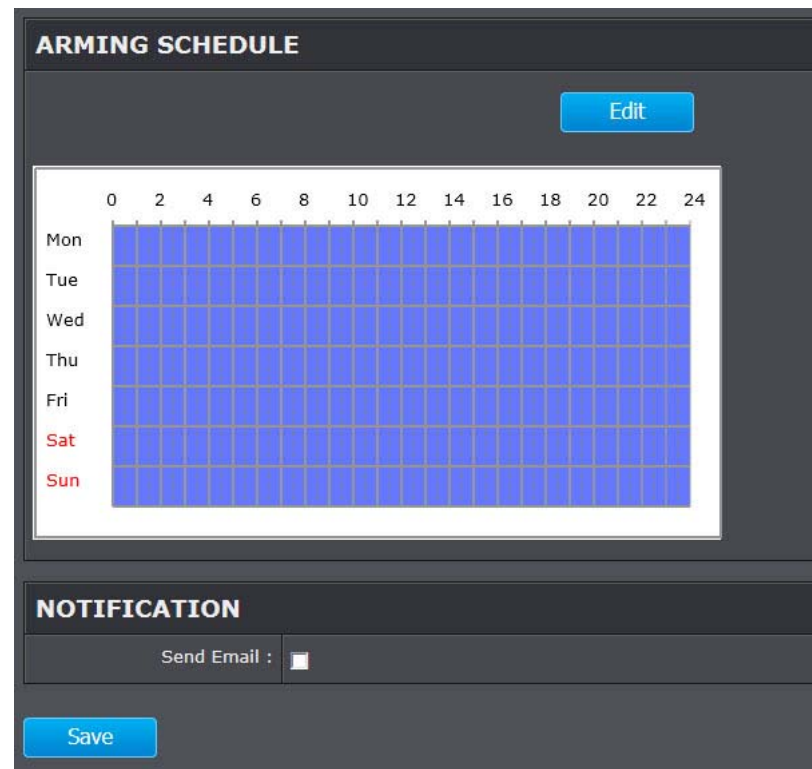

Arming Schedule	
Edit:	Click Edit to define when you want the tamper detection works.

1. Select the day of the week you want to edit the schedule.
2. Set the time period you want to enable tamper detection. (Default is 0-24 hours, all day).
3. Click **Copy to Week** if you want the same daily schedule every day. Or, you can select other day of the week and click **Copy** to copy the schedule of the day to other days.
4. Select another day of the week by clicking on its tab to set the next schedule. Click **OK** when you have finished your settings.

Notification

Send Email: Check this box to send an e-mail notification when motion is detected. Go to Events / Email to setup email account information.

Click **Save** to save the changes

Exception

Provides notifications for other system events, set up your notifications here.

Notification

Exception Type:	First choose the exception type, then choose the corresponding action.
Send Email:	Check this box to send an e-mail notification when motion is detected. Go to Events / Email to setup email account information.

Click **Save** to save the changes

Snapshot

You can set up your camera to continuously take snapshots or take snapshots when an event happens.

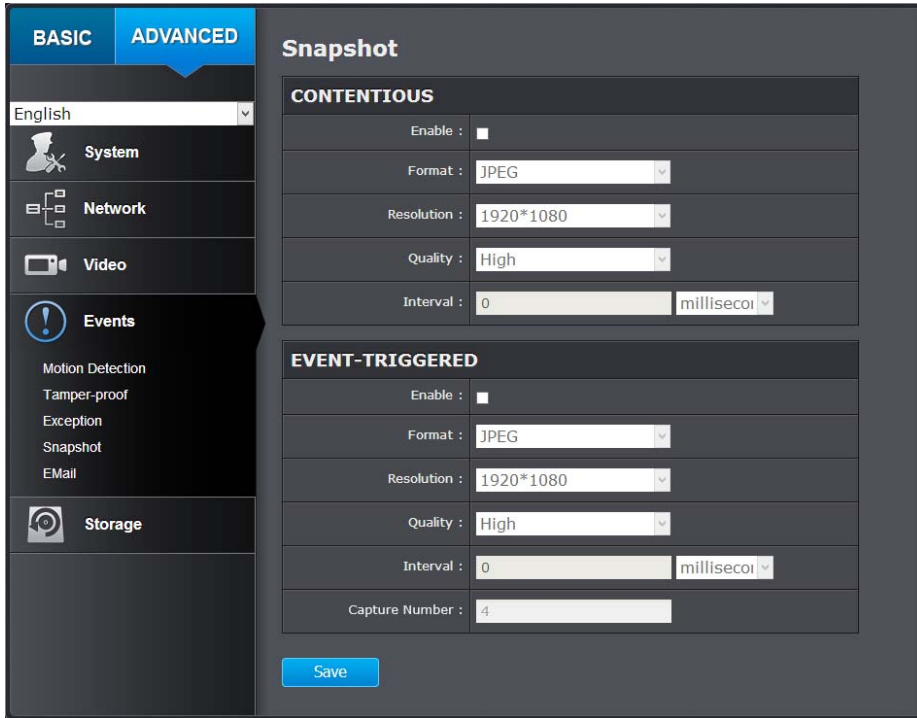

Event Triggered	
Enable:	Check this box to take snapshots when an event is occurred.
Format:	Save snapshots in JPEG format
Resolution:	Uses the same resolution set in Video Format for the snapshot resolution.
Quality:	Choose a compression quality for snapshot.
Interval:	State the time interval between this series of snapshots. The default interval is 1 second.
Capture Number:	State how many snapshots you want to take in a single triggered event. Default: 3 pictures.
Click Save to save the changes	

Continuous	
Enable:	Check this box to continuously take snapshots.
Format:	Save snapshots in JPEG format
Resolution:	Uses the same resolution set in Video Format for the snapshot resolution.
Quality:	Choose a compression quality for snapshots.
Interval:	State the time interval between snapshots. The default interval is 10 seconds.
Click Save to save the changes	

Email

Set up email accounts for notifications.

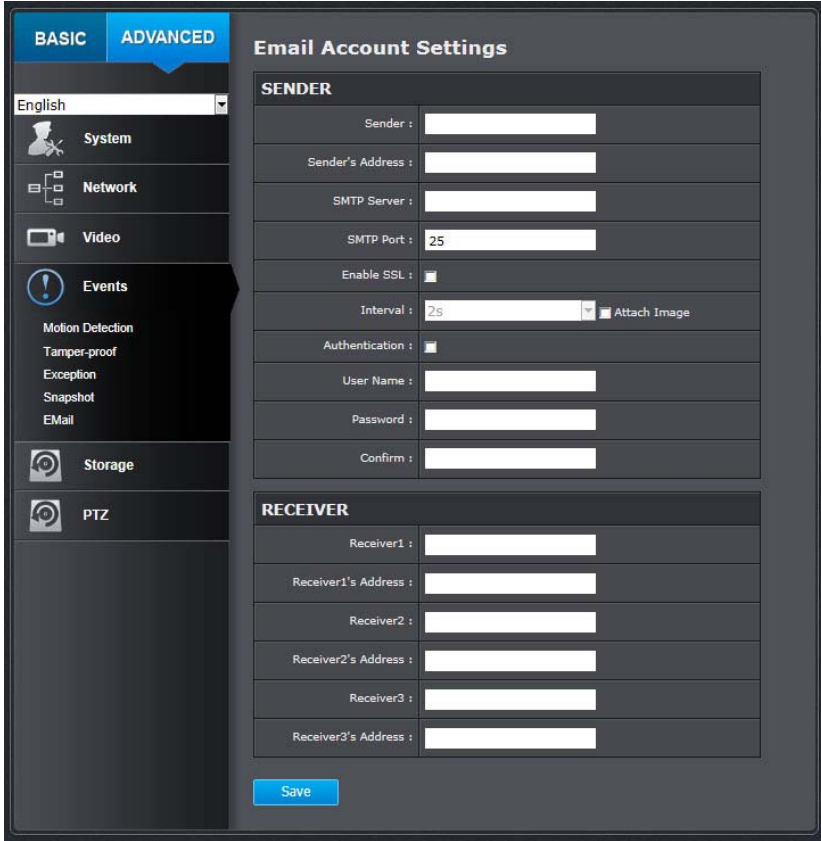

Sender	
Sender:	Enter the name to appear as the email sender.
Sender's Address:	Enter sender's email address.
SMTP Server:	Simple Mail Transportation Protocol Server address, the outgoing email server address. Please ask your email service provider for details.
SMTP Port:	Service port number for outgoing email.*

Enable SSL:	Check this box if your service provider requires a SSL secured connection.
Attach Image/Interval:	Check Attach Image if you want to send a snapshot image with the email notification and select the interval of snapshots in seconds.
Authentication:	Check this box if your server requires a password in order to send email. Most email servers require authentication when sending an email.
User name:	Enter the user name of outgoing email account
Password:	Enter the password
Confirm:	Enter the password again to confirm that the password was entered correctly.
Click Save to save the changes	

Receiver	
Receiver 1:	The first receiver's name.
Receiver 1's Address:	The first receiver's email address.
Receiver 2:	The second receiver's name.
Receiver 2's Address:	The second receiver's email address.
Receiver 3:	The third receiver's name.
Click Save to save the changes	

* Many ISPs do not allow service port 25 going through their network. Other popular ports are 587 and 465. Please consult your email service provider and ISP for details.

Alarm Input

Choose Alarm Input number, name and alarm type. The alarm type could be NO (Normally Open) and NC (Normally closed).

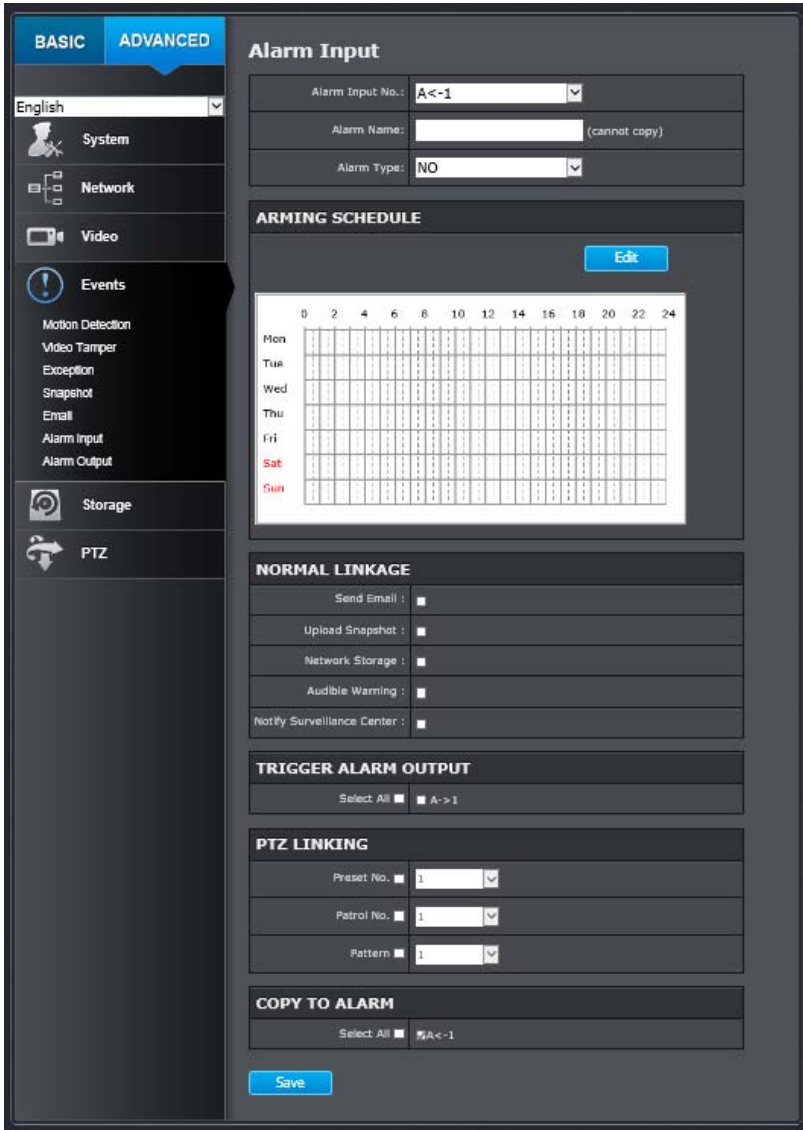

Alarm Input	
Alarm Input No.	Select the alarm input number
Alarm Name	Input the alarm name
Alarm Type	Two alarm types. NO for (Normally Open) and NC (Normally Closed).
Normal Linkage	
Send Email	When the alarm is triggered, the camera will send an email notification.
Upload Snapshot	When the alarm is triggered, the camera will upload a snapshot to FTP.
Network Storage	When the alarm is triggered, the camera will upload video clip to network storage.
Audible Warning	When the alarm is triggered, the camera will have beep sound.
Notify Surveillance Center	When the alarm is triggered, the camera will send a notification message to the VMS.
Trigger Alarm Output	
Select All	Select the Alarm output.
PTZ Linking	
Preset No.	When the alarm input is triggered, the camera will move to this preset location.
Patrol No.	When the alarm input is triggered, the camera will call this patrol.
Pattern	When the alarm input is triggered, the camera will call this pattern.
Copy to Alarm	
Select All	Copy the settings to other alarm. (Note: This option is for the camera that has multiple alarm output channels.)
Click Save to save the changes	

Alarm Output

Choose Alarm Input number, name and alarm type. The alarm type could be NO (Normally Open) and NC (Normally closed).

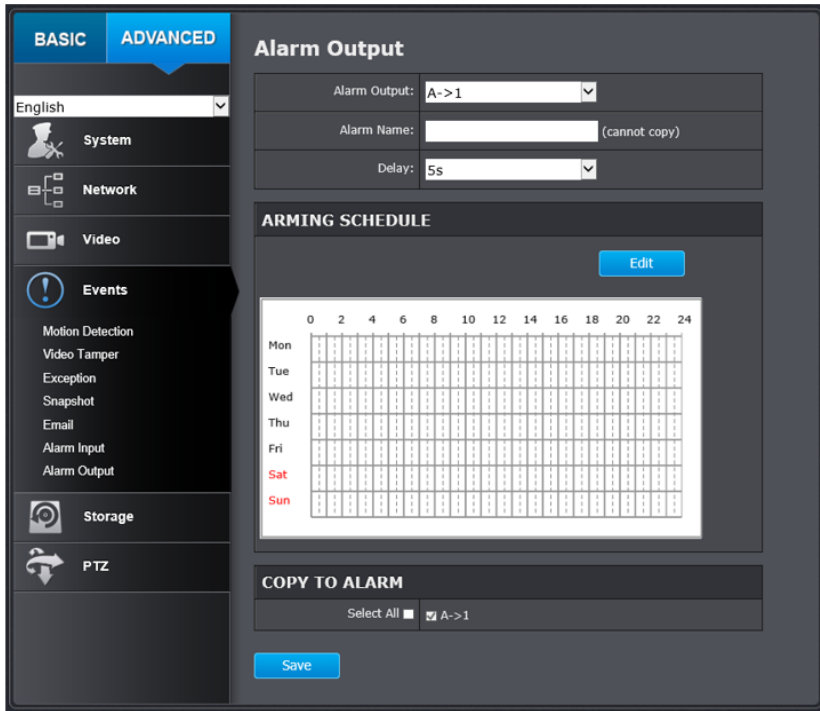

Alarm Output	
Alarm Output	Select the alarm output number
Alarm Name	Input the alarm name
Delay:	Delay time to trigger the alarm output.
Copy To Alarm	
Select All	Copy the settings to other alarm. (Note: This option is for the camera that has multiple alarm output channels.)

Storage

Storage Management

* Micro SD card or Network storage device must be setup / formatted before it can be managed / stored. Camera will save to SD card only when there is no additional NAS device setup.

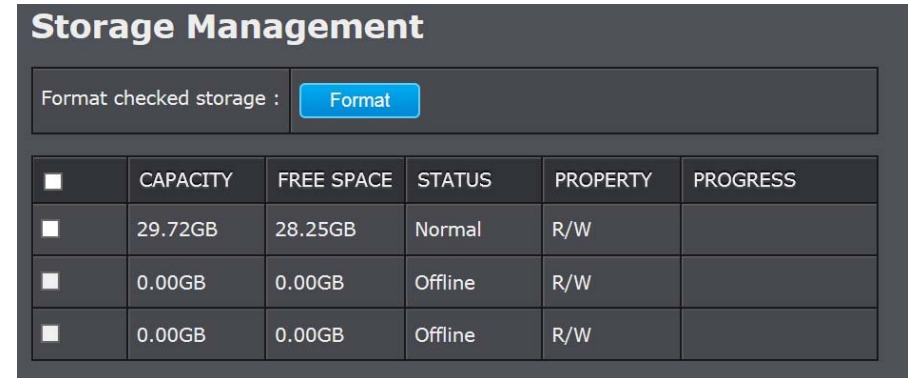

*Micro SD slot is located at the opposite side of the lens under a protective black strip. (Please make sure the environment is dry and clean when opening the dome cover)

Network Storage

* **Network Storage** must be setup before it can be managed. For storage management, please refer to the next section.

The camera supports two formats of network storage file systems: NFS and SMB/CIFS. NFS, Network File System, is natively supported by Linux computers and most NAS, Network Attached Storage. SMB/CIFS, Common Internet File System, is natively supported by Windows® systems and now is generally supported by Linux and OS X®.

You can add up to 8 network storages for your camera. The recordings will subsequently be stored in these spaces. Save video from the first storage and then the next when the first one is full. Click on the entry to change the settings and click **Save** to save the settings.

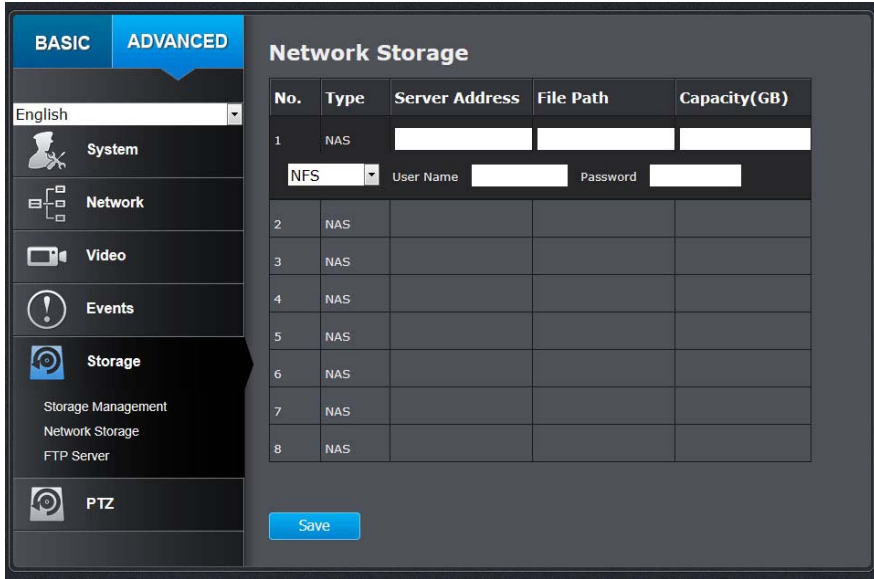

Network Storage	
No:	The sequential number of the network storage.
Type:	The type of storage.
Server Address:	Enter the IP address of your network storage.
File Path:	Enter the file path on the server for network storage.
Capacity:	Enter the size of the disk space you want to assign for this storage. The minimum disk space requirement is 8GB. If you do not want to limit the size and use the full physical disk space, enter 0 in this field.
File System:	Choose between NFS or CIFS for file system. If you assign the network storage on a Windows®

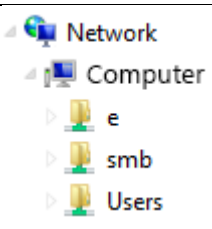
	computer, set it to SMB/CIFS. (if you use an anonymous account, please still enter a random user ID and password before saving)
User Name:	Enter the user name if the network storage requires authentication. Leave it blank if no authentication is required.
Password:	Enter the password to access the network storage.
	Tip: To create network storage on your Windows® based system, create a shared folder and then test your set up with another computer. Enter the IP address of the computer here and enter the shared folder name with a leading forward slash. For example, if you have a shared folder named "SMB", enter "\\SMB" in the File Path .
Click Save to save the changes	

FTP Server

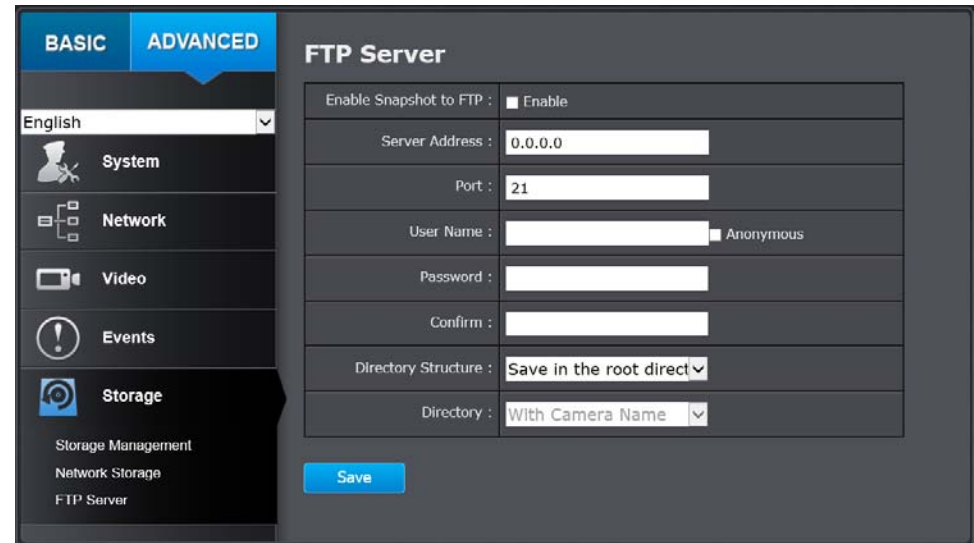

FTP	
Enable Snapshot to FTP:	Check this box if you want to store snapshots on the FTP.
Server Address:	Enter the FTP server IP address.
Port:	Enter the service port number of the FTP server.
User Name/Anonymous:	Check Anonymous if the FTP server does not require authentication. Enter the User Name if the FTP server requires authentication.
Password:	Enter the password of the FTP account.
Confirm:	Enter the password again to make sure the password was entered correctly.
Directory Structure:	When saving snapshots on an FTP server, they can be saved in a single place or organized with meaningful directory names. Save in root directory: You can choose to store all files in the same folder of FTP login. Save in directory: Structure your folders with camera name or IP address.
Directory:	Use Camera Name: Use the camera name to organize the saved files. Use Camera IP: Use the camera IP address to organize the saved files.
Click Save to save the changes	

Pan/Tilt/Zoom (PTZ) Settings

Basic

Basic Parameters	
Enable Proportional Pan:	If you enable this function, the pan/tilt speeds change according to the amount of zoom.
Preset Speed:	You can set the speed of defined preset from 1 to 8.
Keyboard Control Speed:	Define the speed of PTZ control by a keyboard as Low, Normal or High.
Auto Scan Speed:	The camera provides 5 scan modes: auto scan, tilt scan, frame scan, random scan and panorama scan. The scan speed can be set from level 1 to 40.

Max. Tilt-angle:	The maximum angle that the camera can revolve in the tilt direction is adjustable. The values range from (0-90) to (-5-90)
Auto Flip:	You can enable/disable the auto flip function
PTZ OSD	
Zoom Status:	Set the OSD duration of zooming status as 2 seconds to 10 seconds, always on or off.
PT Status:	Set the angle display duration while panning and tilting as 2 seconds to 10 seconds, always on or off.
Preset Status:	Set the preset name display duration as 2 seconds to 10 seconds, always on or off.
POWER OFF MEMORY	
Set Resume Time Point:	The camera can resume its previous PTZ status or actions after it is restarted from a power-off. You can set the time point of which the camera resumes its PTZ status from 30 seconds up to 600 seconds before power-off.
Click Save to save the changes	

Limit

The camera can be programmed to move within the configured stops. (left, right, up or down)

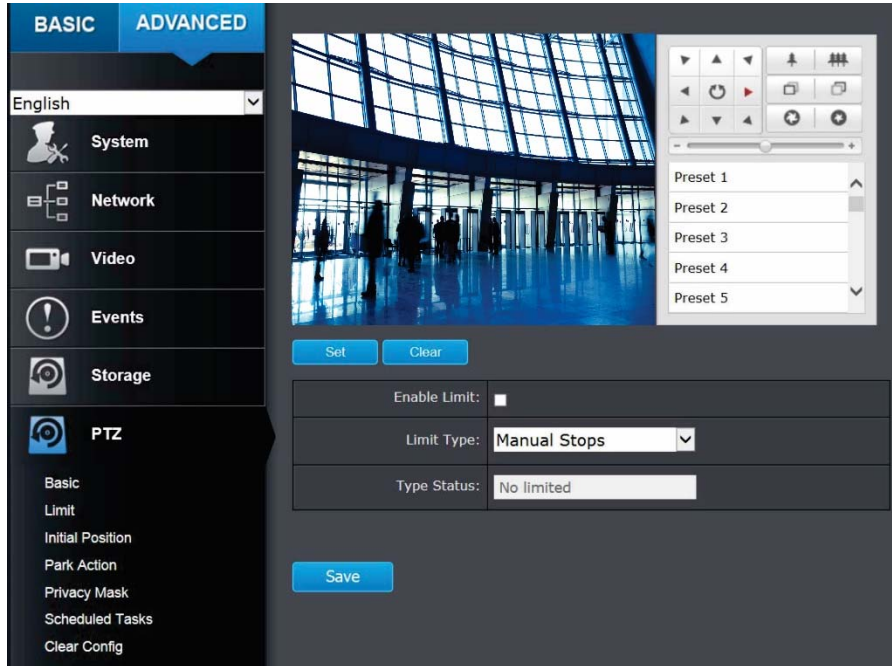

Steps

1. Check the **Enable Limit** box and select Manual Stops or Scan Stops from the Limit Type list.
 - a. When manual limit stops are set, you can operate the PTZ control panel manually only in the limited area.
 - b. When scan limit stops are set, all the scan actions are performed only in the limited area.
2. Click the PTL control buttons to find the left/right/up/down stop limits, you can also call the presets and set them as the limits for the camera.
3. Click Set to save the limits and Clear to clear the limits.

Initial Position

Set the camera initial position, you can also call a preset for the position. Click Set to save the limits and Clear to clear the limits.

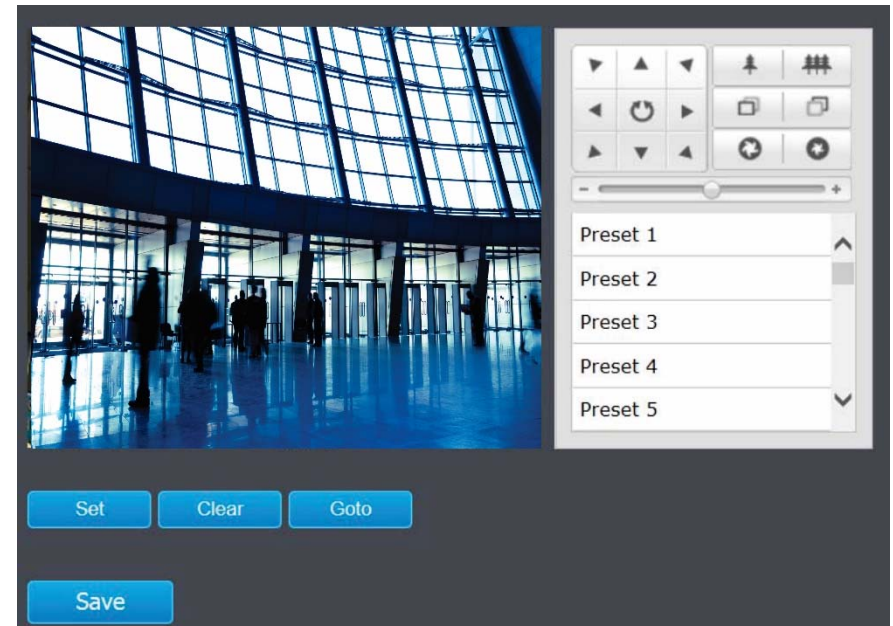

Park Action

The feature allows the camera to start at a predefined park action. (scan, preset, pattern) automatically after a period of inactivity (park time).

Scheduled Tasks function has higher priority over Park Action function therefore when two functions are set at the same time, Scheduled Tasks function takes effect.

Enable Park Action:	<input checked="" type="checkbox"/>
Park Time:	5 second
Action Type:	<ul style="list-style-type: none"> Auto Scan Frame Scan Random Scan Patrol Pattern Preset Panorama Scan Tilt Scan

Private Mask

Create masking area to keep your privacy. You can create up to four independent masking areas by clicking and dragging on the screen.

Enable Privacy Masks

Draw Area Clear All

Privacy Mask List Add Delete

No.	Name	Type	Enable	Active Zoom Ratio

Private Mask	
Enable Privacy Mask:	Check this box to enable privacy masking.
Draw Area:	Click this button to start drawing.
Stop Drawing:	Click this button to stop drawing.
Clear All:	Click this button to clear all the masking areas.
Add:	Click this button to add the mask.
Delete:	Click this button to delete the mask.
Click Save to save the changes	

Schedule Tasks

You can configure the camera to perform a certain action automatically in a user-defined time period.

Enable Scheduled Task:

Park Time: second

Timing Tasks Edit Tasks

0 2 4 6 8 10 12 14 16 18 20 22 24

Mon
Tue
Wed
Thu
Fri
Sat
Sun

Note: Red and green colors are used to distinguish the neighboring scheduled tasks.

Save

Enable the Scheduled Task, define the Park Time and Edit the Tasks that you would like to perform at certain time.

Timing Tasks

Mon Tue Wed Thu Fri Sat Sun

All Day Auto Scan

Customize

Period	Start Time	End Time	Task Type	Task Type ID
1	00:00	24:00	Auto Scan	
2	00:00	00:00	Auto Scan	
3	00:00	00:00	Auto Scan	
4	00:00	00:00	Auto Scan	
5	00:00	00:00	Auto Scan	
6	00:00	00:00	Auto Scan	
7	00:00	00:00	Auto Scan	
8	00:00	00:00	Auto Scan	
9	00:00	00:00	Auto Scan	
10	00:00	00:00	Auto Scan	

Copy to Week Select All

Mon Tue Wed Thu Fri Sat Sun Copy

OK Cancel

1. Choose the day you would like to set the task schedule
2. Click All Day or Customize to enter the Start Time and End Time for each task.
3. Choose the task type from the drop down list.
4. Click OK to save the settings.

Note: The time for each task cannot be overlapped, up to 10 tasks can be configured for each day.

Clear Config

You can clear PTZ configurations all at once in this section, select the desire function and click Save to clear.

Select All:	<input type="checkbox"/>
Clear All Presets:	<input type="checkbox"/>
Clear All Patrols:	<input type="checkbox"/>
Clear All Patterns:	<input type="checkbox"/>
Clear All Privacy Masks:	<input type="checkbox"/>
Clear All PTZ Limited:	<input type="checkbox"/>
Clear All Scheduled Tasks:	<input type="checkbox"/>
Clear All Park Action:	<input type="checkbox"/>

Reset

Software Reset

Refer to Advanced Settings, Maintenance section on [page 23](#)

Hardware Reset

Follow the steps to perform a hardware reset

1. Disconnect the power source form the camera
2. Open the dome cover and find the reset button under the lens



3. Press and hold the reset button then apply power on the device, release the reset button after 10 seconds. The device has now been reset.
4. Close the cover to configure the camera again

Troubleshooting

1. The camera can't be accessed or access is slow

There might be a problem with the network cable. To confirm that the cables are working, ping the address of a known device on the network. If the cabling is OK and your network is reachable, you should receive a reply similar to the following (...bytes = 32 time = 2 ms).

Another possible problem may be that the network device such as a hub or switch utilized by the Network Camera is not functioning properly. Please confirm the power for the devices are well connected and functioning properly.

2. The camera can be accessed locally but not remotely

This might be caused by a firewall. Check the Internet firewall with your system administrator. The firewall may need to have some settings changed in order for the Network Camera to be accessible outside your local LAN. For more information, please refer to the section about installing your camera behind a router.

Make sure that the Network Camera isn't conflicting with any Web server you may have running on your network.

The default router setting might be a possible reason. Check that the configuration of the router settings allow the Network Camera to be accessed outside your local LAN.

3. White vertical lines appear on the image from the camera

It could be that the CMOS sensor (a square panel situated behind the lens that measures the light signals and changes it into a digital format so your computer can present it into an image that you are familiar with) has become overloaded when it has been exposed to bright lights such as direct exposure to sunlight or halogen lights. Reposition the Network Camera into a more shaded area immediately as prolonged exposure to bright lights will damage the CMOS sensor.

4. The camera images are 'noisy'

Often if the camera is in a low-light environment, the images can contain a lot of noise. Try enabling Night mode and see if that improves the image quality. Otherwise, try to use the camera in a location where there is a bit more light source.

5. Video can't be viewed through the web browser interface.

ActiveX might be disabled. If you are viewing the images from Internet Explorer make sure ActiveX has been enabled in the Internet Options menu. You may also need to change the security settings on your browser to allow the ActiveX plugin to be installed.

If you are using Internet Explorer with a version number lower than 6, then you will need to upgrade your Web browser software in order to view the streaming video transmitted by the Network Camera. Try also viewing the video using Java. Ensure that you have the latest version of Java installed before you do. Go to www.java.com for more information.

Federal Communication Commission Interference Statement

This equipment has been tested and found to comply with the limits for a Class B digital device, pursuant to Part 15 of the FCC Rules. These limits are designed to provide reasonable protection against harmful interference in a residential installation. This equipment generates, uses and can radiate radio frequency energy and, if not installed and used in accordance with the instructions, may cause harmful interference to radio communications. However, there is no guarantee that interference will not occur in a particular installation. If this equipment does cause harmful interference to radio or television reception, which can be determined by turning the equipment off and on, the user is encouraged to try to correct the interference by one of the following measures:

Reorient or relocate the receiving antenna.

Increase the separation between the equipment and receiver.

Connect the equipment into an outlet on a circuit different from that to which the receiver is connected.

Consult the dealer or an experienced radio/TV technician for help.

This device complies with Part 15 of the FCC Rules. Operation is subject to the following two conditions: (1) This device may not cause harmful interference, and (2) this device must accept any interference received, including interference that may cause undesired operation.

FCC Caution: Any changes or modifications not expressly approved by the party responsible for compliance could void the user's authority to operate this equipment.

IEEE 802.11b or 802.11g operation of this product in the U.S.A. is firmware-limited to channels 1 through 11.

IMPORTANT NOTE:**FCC Radiation Exposure Statement:**

This equipment complies with FCC radiation exposure limits set forth for an uncontrolled environment. This equipment should be installed and operated with minimum distance 20cm between the radiator & your body.

This transmitter must not be co-located or operating in conjunction with any other antenna or transmitter.

Europe – EU Declaration of Conformity

This device complies with the essential requirements of the R&TTE Directive 1999/5/EC. The following test methods have been applied in order to prove presumption of conformity with the essential requirements of the R&TTE Directive 1999/5/EC:

EN 60950-1:2006+A11:2009+A1:2010+A12:2011

Safety of Information Technology Equipment

EN 62311: 2008

Assessment of electronic and electrical equipment related to human exposure restrictions for electromagnetic fields (0 Hz-300 GHz)

(IEC 62311:2007 (Modified))

EN 300 328 V1.7.1: (2006-10)

Electromagnetic compatibility and Radio spectrum Matters (ERM); Wideband Transmission systems; Data transmission equipment operating in the 2,4 GHz ISM band and using spread spectrum modulation techniques; Harmonized EN covering essential requirements under article 3.2 of the R&TTE Directive

EN 301 489-1 V1.9.2: 2011

Electromagnetic compatibility and Radio Spectrum Matters (ERM); ElectroMagnetic Compatibility (EMC) standard for radio equipment and services; Part 1: Common technical requirements

EN 301 489-17 V2.1.1 (2009-05)

Electromagnetic compatibility and Radio spectrum Matters (ERM); ElectroMagnetic Compatibility (EMC) standard for radio equipment and services; Part 17: Specific conditions for 2,4 GHz wideband transmission systems

This device is a 2.4 GHz wideband transmission system (transceiver), intended for use in all EU member states and EFTA countries, except in France and Italy where restrictive use applies.

In Italy the end-user should apply for a license at the national spectrum authorities in order to obtain authorization to use the device for setting up outdoor radio links and/or for supplying public access to telecommunications and/or network services.

This device may not be used for setting up outdoor radio links in France and in some areas the RF output power may be limited to 10 mW EIRP in the frequency range of 2454 – 2483.5 MHz. For detailed information the end-user should contact the national spectrum authority in France.



This device is designed to provide uninterrupted monitoring and/or recording. This device does not off power management functionality such as Off mode or Standby mode.









IMPORTANT NOTE:**NCC AND FCC Warning Statement**











Note: This country code selection is for non-US models only and is not available to all US models. Per FCC regulation, all WiFi products marketed in the US must be fixed to US operation channels only.

以下警語適用台灣地區

經型式認證合格之低功率射頻電機，非經許可，公司、商號或使用者均不得擅自變更頻率、加大功率或變更原設計之特性及功能。

低功率射頻電機之使用不得影響飛航安全及干擾合法通信；經發現有干擾現象時，應立即停用，並改善至無干擾時方得繼續使用。前項合法通信，指依電信法規定作業之無線電通信。低功率射頻電機須忍受合法通信或工業、科學及醫療用電波輻射性電機設備之干擾。

 Český [Czech]	TRENDnet tímto prohlašuje, že tento TV-IP450P je ve shodě se základními požadavky a dalšími příslušnými ustanoveními směrnice 1999/5/ES.
 Dansk [Danish]	Undertegnede TRENDnet erklærer herved, at følgende udstyr TV- TV-IP450P overholder de væsentlige krav og øvrige relevante krav i direktiv 1999/5/EF.
 Deutsch [German]	Hiermit erklärt TRENDnet, dass sich das Gerät TV-IP450P in Übereinstimmung mit den grundlegenden Anforderungen und den übrigen einschlägigen Bestimmungen der Richtlinie 1999/5/EG befindet.
 Eesti [Estonian]	Käesolevaga kinnitab TRENDnet seadme TV-IP450P vastavust direktiivi 1999/5/EÜ põhinõuetele ja nimetatud direktiivist tulenevatele teistele asjakohastele sätetele.
 English	Hereby, TRENDnet, declares that this TV-IP450P is in compliance with the essential requirements and other relevant provisions of Directive 1999/5/EC.
 Español [Spanish]	Por medio de la presente TRENDnet declara que el TV-IP450P cumple con los requisitos esenciales y cualesquiera otras disposiciones aplicables o exigibles de la Directiva 1999/5/CE.
 Ελληνική [Greek]	ΜΕ ΤΗΝ ΠΑΡΟΥΣΑ TRENDnet ΔΗΛΩΝΕΙ ΟΤΙ TV-IP450P ΣΥΜΜΟΡΦΩΝΕΤΑΙ ΠΡΟΣ ΤΙΣ ΟΥΣΙΩΔΕΙΣ ΑΠΑΙΤΗΣΕΙΣ ΚΑΙ ΤΙΣ ΛΟΙΠΕΣ ΣΧΕΤΙΚΕΣ ΔΙΑΤΑΞΕΙΣ ΤΗΣ ΟΔΗΓΙΑΣ 1999/5/ΕΚ.
 Français [French]	Par la présente TRENDnet déclare que l'appareil TV-IP450P est conforme aux exigences essentielles et aux autres dispositions pertinentes de la directive 1999/5/CE.
 Italiano [Italian]	Con la presente TRENDnet dichiara che questo TV-IP450P è conforme ai requisiti essenziali ed alle altre disposizioni pertinenti stabilite dalla direttiva 1999/5/CE.

 Latviski [Latvian]	Ar šo TRENDnet deklarē, ka TV-IP450P atbilst Direktīvas 1999/5/EK būtiskajām prasībām un citiem ar to saistītajiem noteikumiem.
 Lietuvių [Lithuanian]	Šiuo TRENDnet deklaruoja, kad šis TV-IP450P atitinka esminius reikalavimus ir kitas 1999/5/EB Direktyvos nuostatas.
 Nederlands [Dutch]	Hierbij verklaart TRENDnet dat het toestel TV-IP450P in overeenstemming is met de essentiële eisen en de andere relevante bepalingen van richtlijn 1999/5/EG.
 Malti [Maltese]	Hawnhekk, TRENDnet, jiddikjara li dan TV-IP450P jikkonforma mal-ħtiġijiet essenzjali u ma provvedimenti oħrajn rilevanti li hemm fid-Dirrettiva 1999/5/EC.
 Magyar [Hungarian]	Alulírott, TRENDnet nyilatkozom, hogy a TV-IP450P megfelel a vonatkozó alapvető követelményeknek és az 1999/5/EC irányelv egyéb előírásainak.
 Polski [Polish]	Niniejszym TRENDnet oświadcza, że TV-IP450P jest zgodny z zasadniczymi wymogami oraz pozostałymi stosownymi postanowieniami Dyrektywy 1999/5/EC.
 Português [Portuguese]	TRENDnet declara que este TV-IP450P está conforme com os requisitos essenciais e outras disposições da Directiva 1999/5/CE.
 Slovensko [Slovenian]	TRENDnet izjavlja, da je ta TV-IP450P v skladu z bistvenimi zahtevami in ostalimi relevantnimi določili direktive 1999/5/ES.
 Slovensky [Slovak]	TRENDnet týmto vyhlasuje, že TV-IP450P spĺňa základné požiadavky a všetky príslušné ustanovenia Smernice 1999/5/ES.
 Suomi [Finnish]	TRENDnet vakuuttaa täten että TV-IP450P tyyppinen laite on direktiivin 1999/5/EY oleellisten vaatimusten ja sitä koskevien direktiivin muiden ehtojen mukainen.
 Svenska [Swedish]	Härmed intygar TRENDnet att denna TV-IP450P står i överensstämmelse med de väsentliga egenskapskrav och övriga relevanta bestämmelser som framgår av direktiv 1999/5/EG.

Limited Warranty

TRENDnet warrants its products against defects in material and workmanship, under normal use and service, for the following lengths of time from the date of purchase.

TV-IP450P – 3 Years Warranty

AC/DC Power Adapter, Cooling Fan, and Power Supply carry 1 year warranty.

If a product does not operate as warranted during the applicable warranty period, TRENDnet shall reserve the right, at its expense, to repair or replace the defective product or part and deliver an equivalent product or part to the customer. The repair/replacement unit's warranty continues from the original date of purchase. All products that are replaced become the property of TRENDnet. Replacement products may be new or reconditioned. TRENDnet does not issue refunds or credit. Please contact the point-of-purchase for their return policies.

TRENDnet shall not be responsible for any software, firmware, information, or memory data of customer contained in, stored on, or integrated with any products returned to TRENDnet pursuant to any warranty.

There are no user serviceable parts inside the product. Do not remove or attempt to service the product by any unauthorized service center. This warranty is voided if (i) the product has been modified or repaired by any unauthorized service center, (ii) the product was subject to accident, abuse, or improper use (iii) the product was subject to conditions more severe than those specified in the manual.

Warranty service may be obtained by contacting TRENDnet within the applicable warranty period and providing a copy of the dated proof of the purchase. Upon proper submission of required documentation a Return Material Authorization (RMA) number will be issued. An RMA number is required in order to initiate warranty service support for all TRENDnet products. Products that are sent to TRENDnet for RMA service must have the RMA number marked on the outside of return packages and sent to TRENDnet prepaid, insured and packaged appropriately for safe shipment. Customers shipping from outside of the USA and Canada are responsible for return shipping fees. Customers shipping from outside of the USA are responsible for custom charges, including but not limited to, duty, tax, and other fees.

WARRANTIES EXCLUSIVE: IF THE TRENDNET PRODUCT DOES NOT OPERATE AS WARRANTED ABOVE, THE CUSTOMER'S SOLE REMEDY SHALL BE, AT TRENDNET'S OPTION, REPAIR OR REPLACE. THE FOREGOING WARRANTIES AND REMEDIES ARE EXCLUSIVE AND ARE IN LIEU OF ALL OTHER WARRANTIES, EXPRESSED OR IMPLIED, EITHER IN FACT OR BY OPERATION OF LAW, STATUTORY OR OTHERWISE, INCLUDING

WARRANTIES OF MERCHANTABILITY AND FITNESS FOR A PARTICULAR PURPOSE. TRENDNET NEITHER ASSUMES NOR AUTHORIZES ANY OTHER PERSON TO ASSUME FOR IT ANY OTHER LIABILITY IN CONNECTION WITH THE SALE, INSTALLATION MAINTENANCE OR USE OF TRENDNET'S PRODUCTS.

TRENDNET SHALL NOT BE LIABLE UNDER THIS WARRANTY IF ITS TESTING AND EXAMINATION DISCLOSE THAT THE ALLEGED DEFECT IN THE PRODUCT DOES NOT EXIST OR WAS CAUSED BY CUSTOMER'S OR ANY THIRD PERSON'S MISUSE, NEGLIGENCE, IMPROPER INSTALLATION OR TESTING, UNAUTHORIZED ATTEMPTS TO REPAIR OR MODIFY, OR ANY OTHER CAUSE BEYOND THE RANGE OF THE INTENDED USE, OR BY ACCIDENT, FIRE, LIGHTNING, OR OTHER HAZARD.

LIMITATION OF LIABILITY: TO THE FULL EXTENT ALLOWED BY LAW TRENDNET ALSO EXCLUDES FOR ITSELF AND ITS SUPPLIERS ANY LIABILITY, WHETHER BASED IN CONTRACT OR TORT (INCLUDING NEGLIGENCE), FOR INCIDENTAL, CONSEQUENTIAL, INDIRECT, SPECIAL, OR PUNITIVE DAMAGES OF ANY KIND, OR FOR LOSS OF REVENUE OR PROFITS, LOSS OF BUSINESS, LOSS OF INFORMATION OR DATE, OR OTHER FINANCIAL LOSS ARISING OUT OF OR IN CONNECTION WITH THE SALE, INSTALLATION, MAINTENANCE, USE, PERFORMANCE, FAILURE, OR INTERRUPTION OF THE POSSIBILITY OF SUCH DAMAGES, AND LIMITS ITS LIABILITY TO REPAIR, REPLACEMENT, OR REFUND OF THE PURCHASE PRICE PAID, AT TRENDNET'S OPTION. THIS DISCLAIMER OF LIABILITY FOR DAMAGES WILL NOT BE AFFECTED IF ANY REMEDY PROVIDED HEREIN SHALL FAIL OF ITS ESSENTIAL PURPOSE.

Governing Law: This Limited Warranty shall be governed by the laws of the state of California.

Some TRENDnet products include software code written by third party developers. These codes are subject to the GNU General Public License ("GPL") or GNU Lesser General Public License ("LGPL").

Go to <http://www.trendnet.com/gpl> or <http://www.trendnet.com> Download section and look for the desired TRENDnet product to access to the GPL Code or LGPL Code. These codes are distributed WITHOUT WARRANTY and are subject to the copyrights of the developers. TRENDnet does not provide technical support for these codes. Please go to <http://www.gnu.org/licenses/gpl.txt> or <http://www.gnu.org/licenses/lgpl.txt> for specific terms of each license.

8.14.2015. 1.04

TRENDnet[®]

Product Warranty Registration

Please take a moment to register your product online.
Go to TRENDnet's website at <http://www.trendnet.com/register>

TRENDnet
20675 Manhattan Place
Torrance, CA 90501. USA

Copyright ©2015. All Rights Reserved. TRENDnet.