

TRENDNET[®]



Quick Installation Guide

TV-IP344PI / TV-IP345PI (V2)

Table of Contents

1 English

1. Before You Start
2. Hardware Installation and Configuration

1. Before You Start

Package Contents

- TV-IP344PI / TV-IP345PI
- Torx Security Allen Key (TV-IP345PI only)
- Quick Installation Guide
- Weather Seal

Minimum Requirements

- A computer with an Ethernet port and web browser
- PoE network
- Network cable

Free Mobile App: TRENDnet IPView Requirements

Supported Operating Systems
Android (version 4.4 or above) iOS (version 8.2 or above)

Using a PoE switch

Note:

- Connect the TV-IP344PI / TV-IP345PI to your network using an existing 802.3af/at compliant PoE switch or injector.
- For outdoor installation, please configure weather seal (included) per the diagram below, you will have to terminate the RJ-45 connector after the weather seal has been applied.

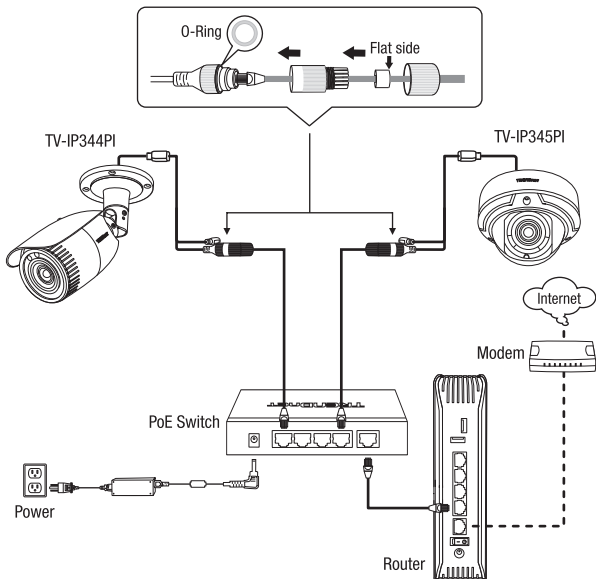

2. Hardware Installation and Configuration

1. Do not install or mount the IP camera until after you complete the installation steps below. Temporarily place the IP camera next to your computer.
2. Download the utility at <http://www.trendnet.com/camerautility>
3. Extract the file, install and run the camera utility.

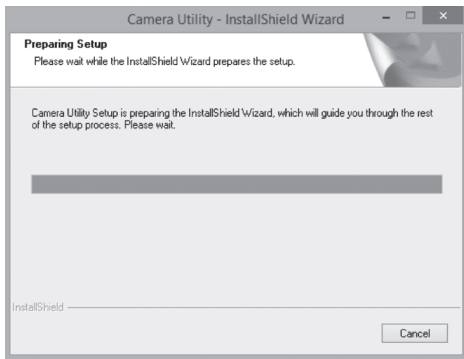

4. Run the utility and find the inactive camera under the security column. To activate the device, click the check box in the left column and enter a new password on the right side.

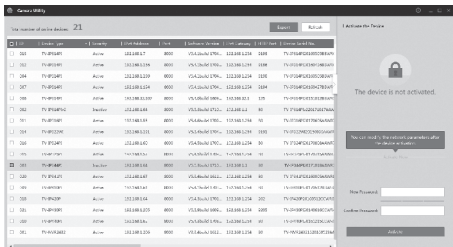

5. Once the device is activated, Double click on the IP address to open the web browser management interface.

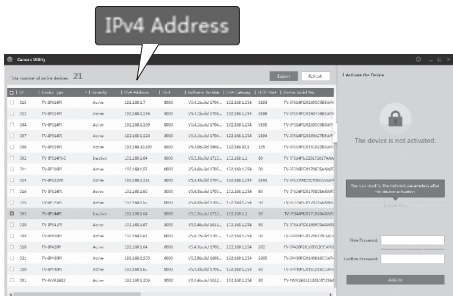

Note: Internet Explorer or Google Chrome web browser needed for installation interface.

6. Now you can access the camera's configuration page for live view and additional settings. For more details, please refer to the User's Guide from our website.



7. Scan the QR code below to download a free mobile app to view the camera from your iOS or Android device.



Android



iOS

Note:

Download	Link
User's Guide	www.trendnet.com/support
Camera Utility	www.trendnet.com/camerautility
TRENDnetView Evo	www.trendnet.com/products/trendnetviewevo

Mounting the camera

1. Place the provided template label on the wall or ceiling.

For TV-IP344PI

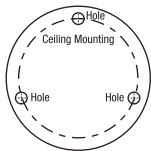

For TV-IP345PI

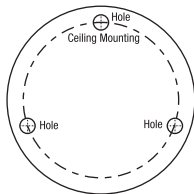

2. Drill holes at each marked position on the template. Make sure the drill bit matches the size of the holes on the template.
3. Remove the dome cover using the provided Torx security allen key.

4. Insert the screw anchors into the holes, and align the mounting base over them. Then use the provided screws to secure the camera to the mounting surface.

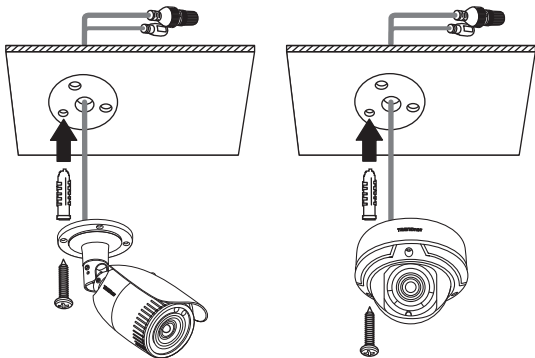

- 4A. (Bullet) Manually adjust your camera to the desired viewing position.

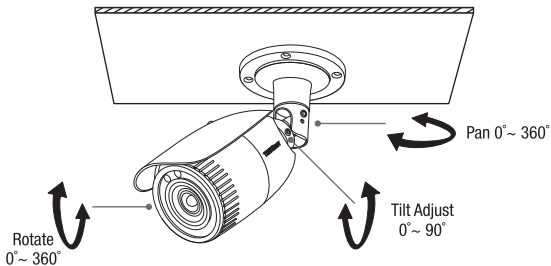

- 4B. (Dome) Manually adjust your camera to the desired viewing position. When finished, attach the dome cover back on the dome using the Torx security allen key.

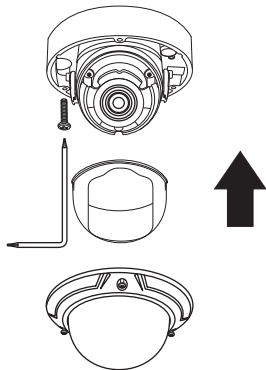
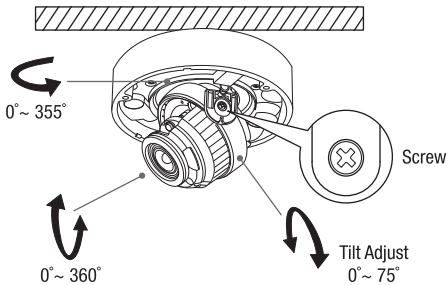

Declaration of Conformity

TRENDnet®

Manufacturer's Name and Address

TRENDnet, Inc.
20675 Manhattan Place
Torrance, CA 90501 USA

Zwolsestraat 156 2587 WB
The Hague The Netherlands



Product Information

Model Number: TV-IP344PI / TV-IP345PI

Product Name: Indoor/Outdoor 4MP H.265 Motorized Varifocal PoE IR Bullet Network Camera
Indoor/Outdoor 4MP H.265 Motorized Varifocal PoE IR Dome Network Camera

Trade Name: TRENDnet

TRENDnet hereby declare that the product is in compliance with the essential requirements and other relevant provisions under our sole responsibility.

EMC: EN 55022: 2010 + AC: 2011 Class A
EN 61000-3-2: 2006 + A1: 2009 + A2: 2009
EN 61000-3-3: 2008
EN 50130-4: 2011 + A1: 2014

This product is herewith confirmed to comply with the Directives.

Directives: Directive LVD 2014/35/EU
Directive EMC 2014/30/EU
Directive RoHS 2011/65/EU
REACH Règlement (EU) N° 1907/2006

Person responsible for this declaration.

Place of Issue: Torrance, California, USA

Date: January 11, 2019

Name: Sonny Su

Title: Director of Technology

Signature: 



Certifications

This device complies with Part 15 of the FCC Rules. Operation is subject to the following two conditions: (1) this device may not cause harmful interference, and (2) this device must accept any interference received. Including interference that may cause undesired operation.



Waste electrical and electronic products must not be disposed of with household waste. Please recycle where facilities exist. Check with your Local Authority or Retailer for recycling advice.

Technical Support

If you have any questions regarding the product installation, please contact our Technical Support. Toll free US/Canada: **1-866-845-3673**
Regional phone numbers available at www.trendnet.com/support

TRENDnet

20675 Manhattan Place
Torrance, CA 90501
USA

Applies to PoE Products Only: This product is to be connected only to PoE networks without routing to the outside plant.

Note

The Manufacturer is not responsible for any radio or TV interference caused by unauthorized modifications to this equipment. Such modifications could void the user's authority to operate the equipment.

Advertencia

En todos nuestros equipos se mencionan claramente las características del adaptador de alimentación necesario para su funcionamiento. El uso de un adaptador distinto al mencionado puede producir daños físicos y/o daños al equipo conectado. El adaptador de alimentación debe operar con voltaje y frecuencia de la energía eléctrica domiciliar existente en el país o zona de instalación.

Product Warranty Registration

Please take a moment to register your product online. Go to TRENDnet's website at: **www.trendnet.com/register**