

User's Guide

TRENDNET[®]



Outdoor 3 MP PoE Day/Night Network Camera

TV-IP310PI

Table of Contents

Product Overview	1	Playback.....	20
Features.....	1	Log.....	23
Package Contents.....	2	System Information.....	24
Front View.....	3	System Configuration	25
Mounting Holes.....	3	Device Settings.....	25
Connectors.....	3	User Accounts.....	26
Installation Procedure	5	Time Settings.....	26
Plan for installation location	5	Daylight Savings.....	27
Viewing angle.....	5	Live View Settings.....	28
Weather Conditions.....	5	Maintenance.....	29
Setup Your Camera with CD	6	Network Settings	30
Hardware Installation	9	TCP/IP.....	30
Cabling.....	9	Port.....	31
Waterproof cap.....	9	DDNS.....	31
Mount your camera.....	10	PPPoE.....	32
Access your Camera Through the Web Browser	11	SNMP.....	32
System Management and Default Settings.....	11	802.1X.....	34
Logging-in to the Camera for the First Time (Windows).....	11	IP Address Filter.....	34
Logging-in to the Camera for the First Time (OS X).....	14	QoS, Quality of Service.....	35
Live View.....	19	UPnP.....	35

Video Settings	36
Video Format	36
Display Settings.....	37
On Screen Display Settings.....	39
Text Overlay	40
Privacy Mask.....	40
Video Recording.....	41
Events	42
Motion Detection	42
Tamper-proof	44
Exception	46
Snapshot	47
Email	48
Network Storage	49
Network Storage	49
Storage Management	50
FTP Server	50

Product Overview



Features

The Outdoor 3 MP PoE Day/Night Network Camera, model TV-IP310PI, provides powerful 3 megapixel night vision in complete darkness for up to 30 meters (100 ft.) This ultra-compact camera is outdoor ready with an IP66 weather rated housing. It comes with a free Apple® and Android™ mobile app and complimentary pro-grade software to manage up to 32 TRENDnet cameras.

PoE

Save installation costs with Power over Ethernet (PoE)

Power Port

Optional power port for non-PoE installation

Outdoor Ready

Outdoor IP66 weather rated

Sun Visor

Sun visor increases image quality throughout the day

Compact

Ultra-compact housing

3 Megapixel

Record 2048 x 1538 pixel video at 15 fps in H.264 compression

Night Vision

Night vision up to 30 meters (100 ft.) in complete darkness

Digital Zoom

Digitally zoom anywhere within the viewing field

IPv6

IPv6 support

Advanced Playback

Advanced in-camera archived video review functionality

D-WDR

Digital Wide Dynamic Range improves video quality in high contrast lighting environments

Storage

Samba video support with notification if storage drive is full

Free Apps

See live video on a mobile device with free Apple® and Android® apps

Complimentary Software

Complimentary pro-grade software to manage up to 32 TRENDnet cameras

Package Contents

TV-IP310PI package includes:

- TV-IP310PI
- Multi-Language Quick Installation Guide
- CD-ROM (Utility and User's Guide)
- Installation hardware

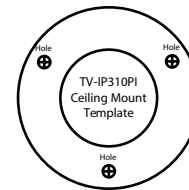

Drilling Template

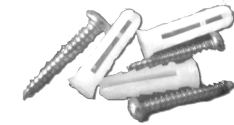

Wall Mount Screws



Network cable waterproof kit

If any package contents are missing or damaged, please contact the retail store, online retailer, or reseller/distributor from which the product was purchased.

Front View



Sun Shield	Protect camera lens from direct exposure to the Sun.
Reset Button	Push and hold the reset button then power on the camera. Keep holding the reset button for more than 10 seconds to reset configuration to factory default.
Grounding Screw	Connects to electric ground.
Lock Ring	Loosen to adjust the camera position. Tighten to hold the camera position.
Ambient Light Sensor	Detects the brightness in the environment and enable day/night modes automatically.
IR LED	Infra-red LEDs for night vision.

Mounting Holes

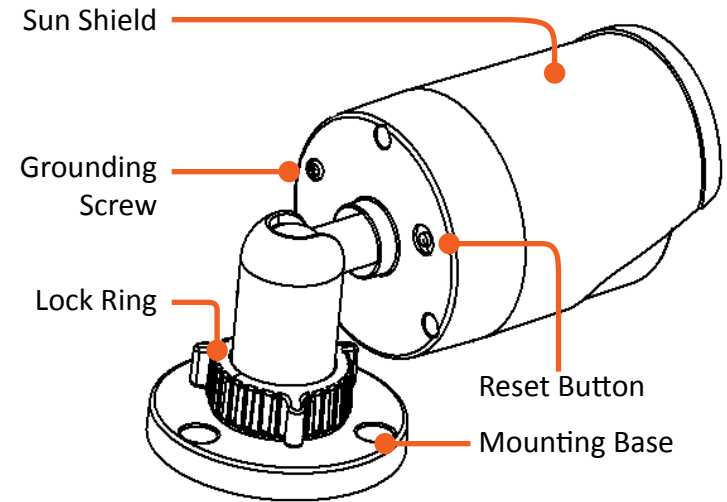

Connectors

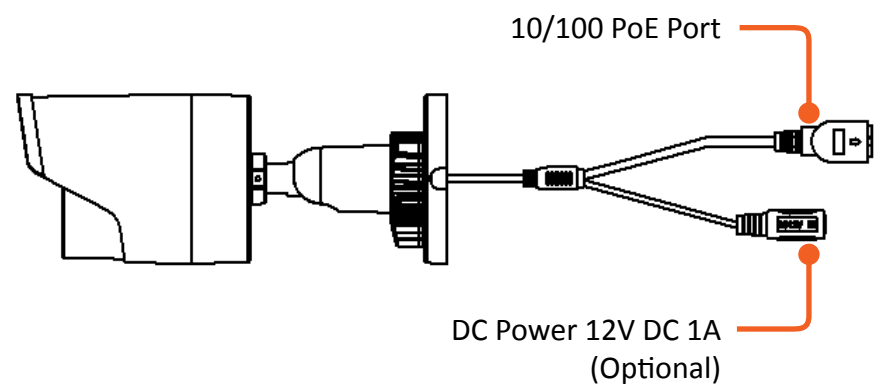

Warnings: Serious injury or death may be caused if any of these warnings are neglected. Follow these safety guards to prevent serious injury or death.

Warnings:

- If using the power adapter, please choose the power adapter that meets the safety extra low voltage (SELV) standard or IEC60950-1 and Limited Power Source standard.
- If the product does not work properly, please contact your dealer or the nearest service center. Never attempt to disassemble the camera yourself. Disassembling the product will void the warranty and may cause harm or injury.
- To reduce the risk of fire or electrical shock, do not expose this product to rain or water.
- The installation should be done by a qualified service person and should conform to all construction and electric regulations and other local codes.

Cautions: Injury or equipment damage may be caused if any of these cautions are neglected. Follow these precautions to prevent potential injury or material damage.

Cautions:

- Make sure the power supply voltage is correct before using the camera.
- Do not drop the camera or subject to physical shock.
- Do not touch sensor modules with fingers. If cleaning is necessary, use a clean cloth with a bit of ethanol and wipe it gently. If the camera will not be used for an extended period of time, put on the lens cap to protect the sensor from dirt.
- Do not aim the camera lens at the strong light such as the Sun or an incandescent lamp. Strong light can damage the camera sensor.
- The sensor may be burned out by a laser beam, so when any laser equipment is being used, make sure that the surface of the sensor will not be exposed to the laser beam.
- Do not place the camera in extremely hot, cold temperatures (the operating temperature should be between -10°C to 60°C), dusty or damp environment, and do not expose it to high electromagnetic radiation.
- To avoid heat accumulation, good ventilation is required for a proper operating environment.
- Keep out of water and any liquid.
- While shipping, the camera should be packed in its original packing.

Installation Procedure

There are a number of factors involved in successful camera installation. Follow the suggested installation steps and go through the check lists. This guide will help you make your camera installation smooth and easy.

- **Plan for installation location, see page 5 (next paragraph)**
- **Setup Your Camera with CD, see page 6**
- **Hardware Installation, see page 9**

Plan for installation location

Viewing angle

The TV-IP310PI is a bullet camera with a focused viewing angle (70° horizontal and 52° vertical) that provides non-distorted and detailed images. Choose the location where has good a angle to shoot the image you expect to see. The motion detection area should also be considered when installing the camera.

Weather Conditions

The TV-IP310PI is a small bullet camera, which fits most installations indoor and out door. The camera can work under a wide range of weather conditions. For severe weather conditions, a camera housing with temperature and moisture control is recommended. Using the camera in milder weather conditions will help extend the camera's life and preserve the quality of the camera image.

- **Moisture:** Avoid damp or moist environments whenever you can. The TV-IP310PI is an IP66 grade water proof camera, and it will work in moist environments. However, rain may affect the picture quality, especially at night, water may reflect the light from the infra-red illumination and degrade picture quality.
- **Temperature:** TV-IP310PI works within a specified temperature range. Areas with severe temperatures should be avoided when installing the camera. It's recommended that you use an enclosure with a heater and blower if you plan on using this camera outside of the specified temperature range.
- **Sunlight:** Avoid direct sun light exposure. Direct sun light will damage the image sensor. If sunlight is necessary for your viewing purposes, provide protection for the image sensor.
- **Lighting:** Consider installing your camera faces the same direction of the light sources. Shooting images with top-down position outdoor or next to the existing light source are good choices. Avoid the light source if it creates a shade that darkens the viewing area.

Setup Your Camera with CD

1. Insert the Installation CD-ROM into your computer's CD-ROM drive to initiate the Auto-Run program. Choose your preferred language and then click the **Install Camera**.

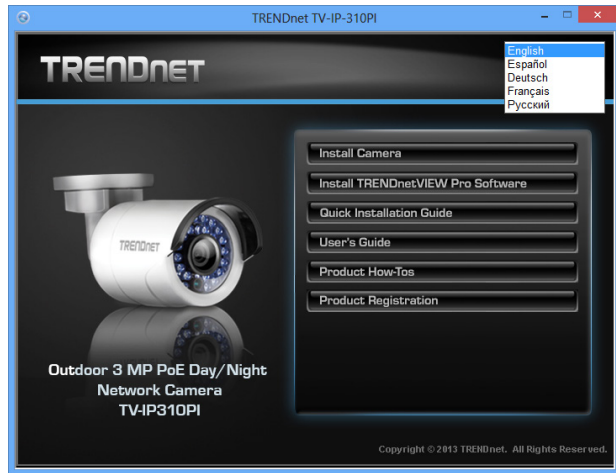

2. Write down the MAC Address of the camera.



3. Connect a PoE capable network cable to the camera's network port and then to a PoE switch and wait for the camera to boot up. Click **Next** when you are done.

** A power adapter (sold separately) can be used instead of PoE switch.*

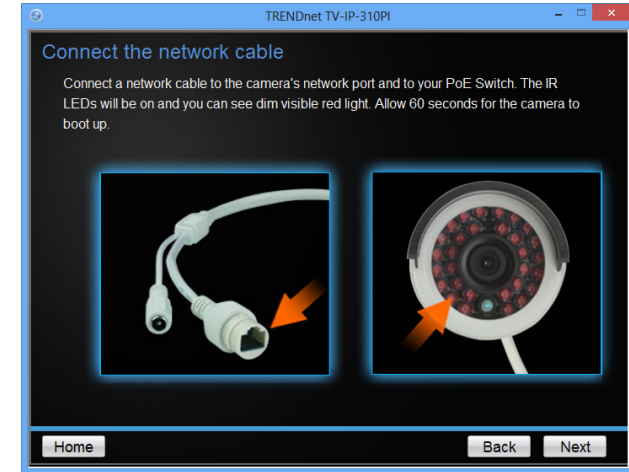

4. Wait while the utility searches for the camera.

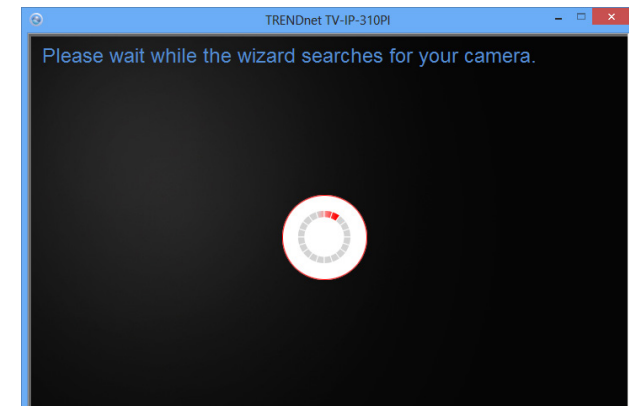

- The installation wizard will list cameras found on your network. If only one camera is found, it will be selected by default. If you have more than one camera on the network, please choose the camera you wish to set up by identifying its MAC address. Select the camera and then click **Next**.

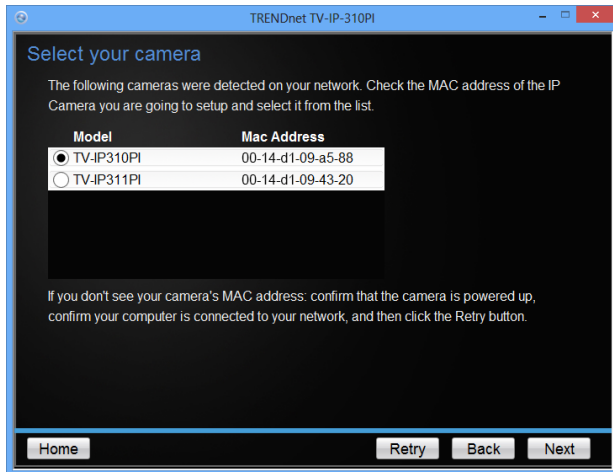

- Select the **DHCP** option to assign IP address dynamically, or select **Fixed IP** to assign the camera an IP address, then click **Next**.

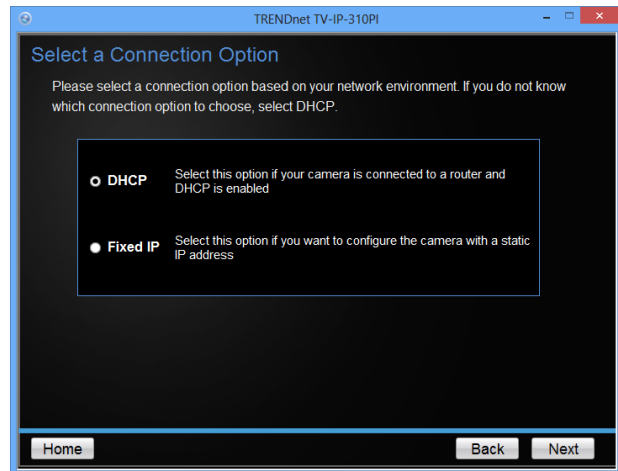

- If you select **Fixed IP**, enter the IP address, subnet mask, default gateway, and DNS server address. Please make sure the IP address you are setting on the camera is in the same network of the computer that you are using. Click **Next**.

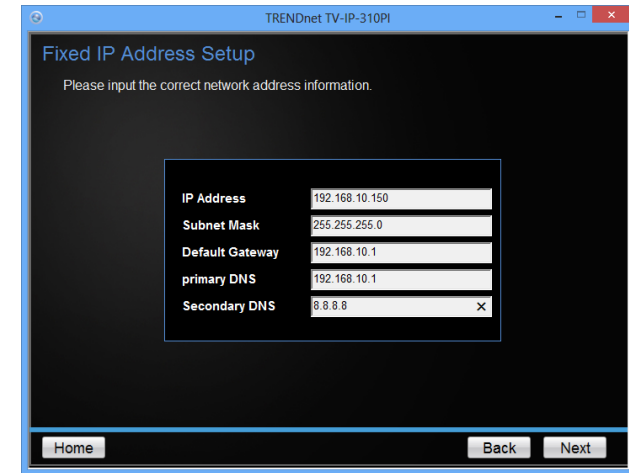

- Enter a new password. The default password is **admin**. You are required to change the password from the default setting to prevent unauthorized access. Enter the default password: **admin** and enter the new passwords for a brand new installation*. The password must be between 8 and 16 characters. (Alphanumeric: a-z, A-Z, 0-9, !, @, #, \$).

This camera installation wizard is also good for finding the camera if it was setup with DHCP. The IP address may change dynamically with the DHCP setting. If you want to access your camera again and you don't know the IP address, you can run this camera installation wizard again. If you have already setup the password and want to keep the password unchanged, un-check the **Change Password box and click next to get the link to access your camera.)*

TRENDnet TV-IP-310PI

Change password

You **MUST** change the default password of the camera.
 Enter the default password: admin
 Enter your new password: must be between 8 and 16 characters. (Alphanumeric: a-z, A-Z, 0-9)

Admin ID:

Password:

Change Password

New password:

Confirm new password:

Home Back Next

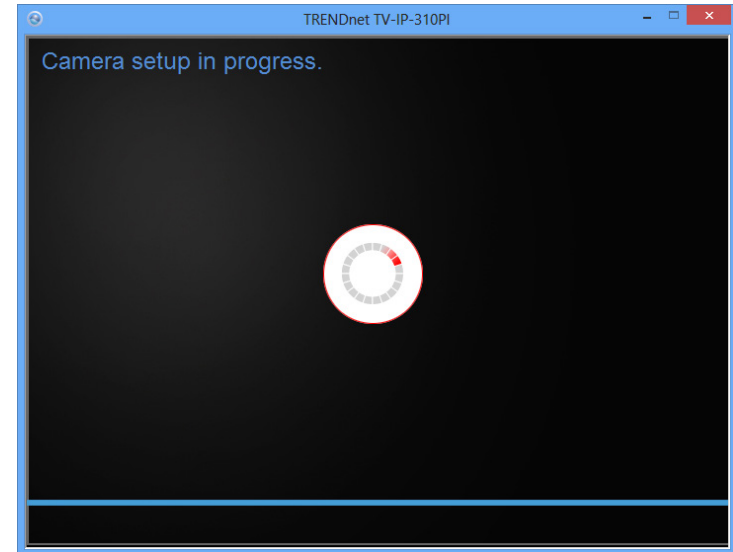

- Click **here** to access to the camera's web page or click **Next** for mobile app installation.

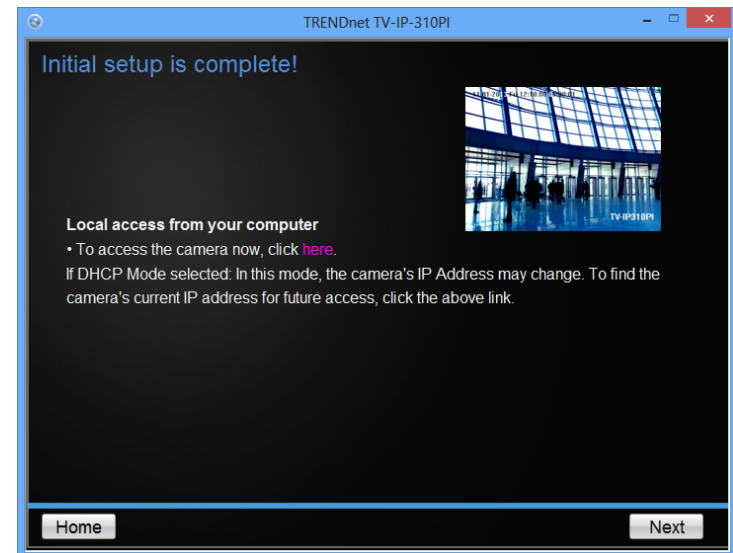

- Click **Finish** to exit the program or click **Home** to return to the main screen. You can also download a free app to view video on your mobile devices. Scan the QR code to find and install the TRENDnet VIEW app.



Free App

Night Vision

Hardware Installation

Cabling

It's recommended that the wiring the cable in your home or office by a professional. If you already have the cable deployed, make sure the cable and the connectors meet the category 5 Ethernet cable standard. At least 2 pairs of twisted lines are required for power and data. Poor cable quality may cause unexpected problems. Testing your cable or running a new cable is suggested for new camera installation.

Waterproof cap

The TV-IP310PI itself is IP66 grade water and dust proof. There is a set of network cable water proof caps that comes with the package as well. Run your cable going through the accessories, then crimp the cable with an RJ45 module. Plug in the network cable and then tighten the waterproof cap to prevent water from running into camera through the cable.

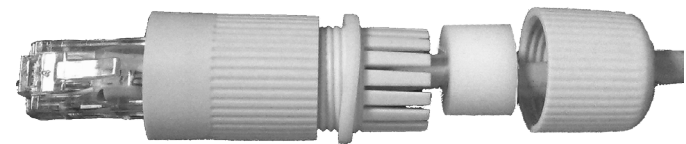

Mount your camera

Drill the screw holes and the cable hole if necessary with the drill template comes with the package.

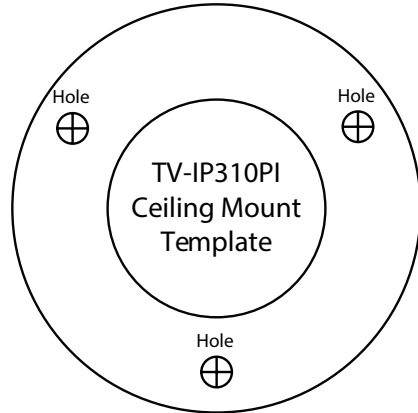

Fix the mounting base on the ceiling or the wall with the screws that come with the package. Route the cables to the cable hole.

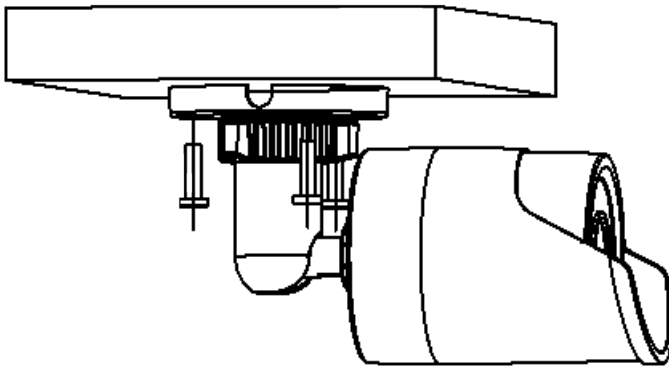

Loosen the lock ring and then adjust the camera position. Tighten the lock ring when you setup the camera position.

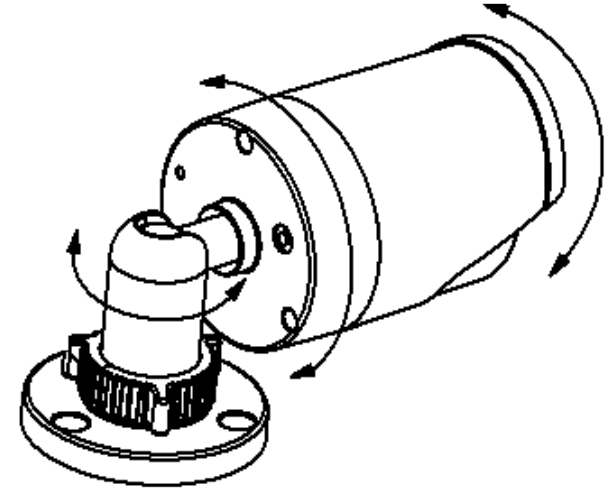

Access your Camera Through the Web Browser

System Management and Default Settings

It is recommended that you install your camera with the CD that comes with the package and use accompanying TRENDnetVIEW Pro software for Windows computers. If you do not have the CD with you, you can go to <http://www.TRENDnet.com/support> enter the model number "TV-IP310PI" and download the software.

If you didn't go through the TV-IP310PI CD installation wizard or you have reset the TV-IP310PI to factory defaults by pressing and holding reset button for over 10 seconds while power on the camera, your TV-IP310PI has following settings:

Management IP : Dynamic assigned if there's a
DHCP server on the network or
192.168.10.30

Administrator name : admin

Administrator password : admin

If you want to access your camera directly instead of using software, you can follow the steps specified in this chapter to login to your camera. A web browser plug-in must be installed to watch video smoothly.

For **Windows** system, please go to the next paragraph.

For **OS X** system, please go directly to page 14

Logging-in to the Camera for the First Time (Windows)

- 1 Open the web browser on your computer. In the address bar, enter the IP address you setup through the setup CD or 192.168.10.30. (If you have a DHCP server on your network, the IP address will be assigned dynamically. For example, if you have a home gateway on your network and you plug-in the camera on the same network, you can find the camera's IP address on your home gateway.), and then press **Enter**.

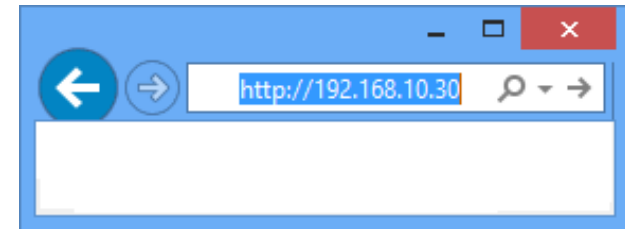

- 2 Enter the user name, **admin**, and the password you setup through the setup CD or the default password, **admin**, and then click **OK**.

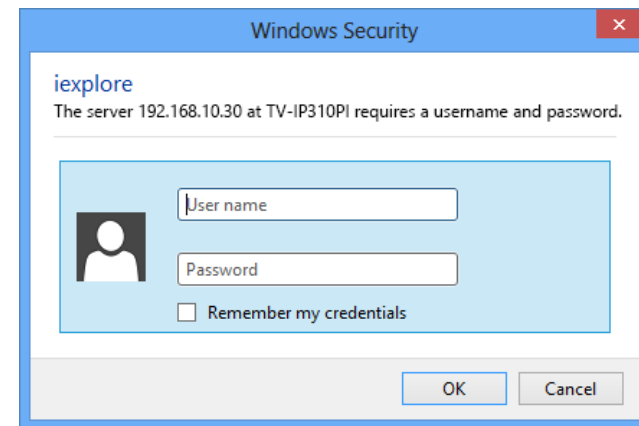

- 3** The camera management page will detect if you installed the camera video streaming plug-in or not. Click the link to download the plug-in from the TV-IP310PI camera.

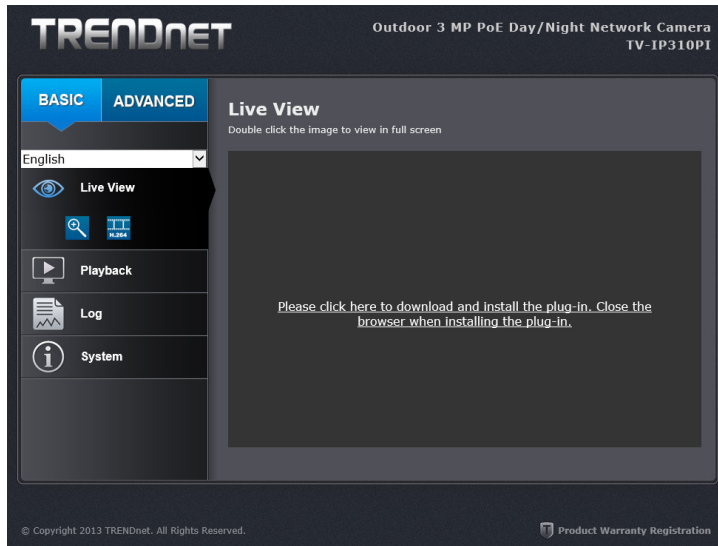

- 4** Click **Run** to directly run plug-in installation and close your browser while you install the plug-in.

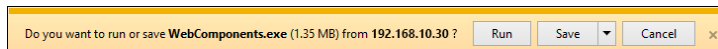

- 5** Permission request depends on the Internet security settings of your computer. Click **More Info** and then **Run anyway** to install the plug-in.

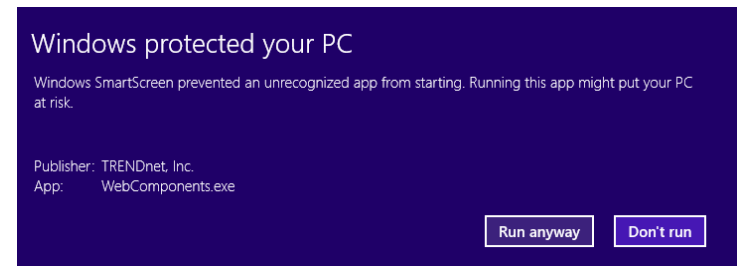
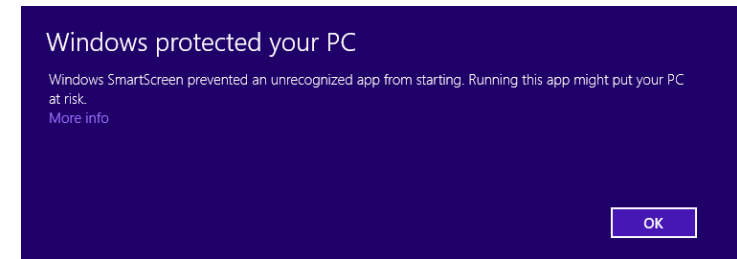

- 6** Click **Next** to install the plug-in.

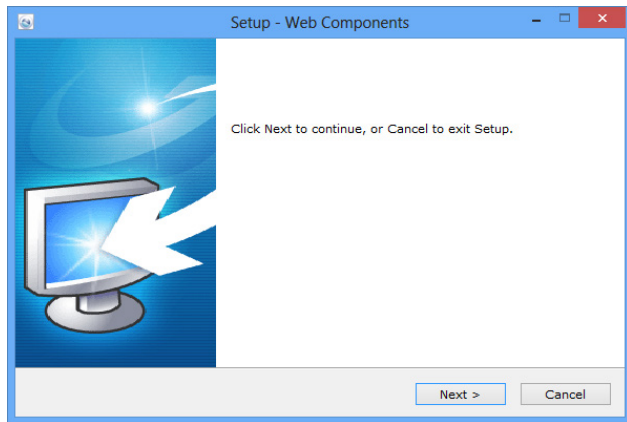

- 7** Click **Finish** to finish the installation.

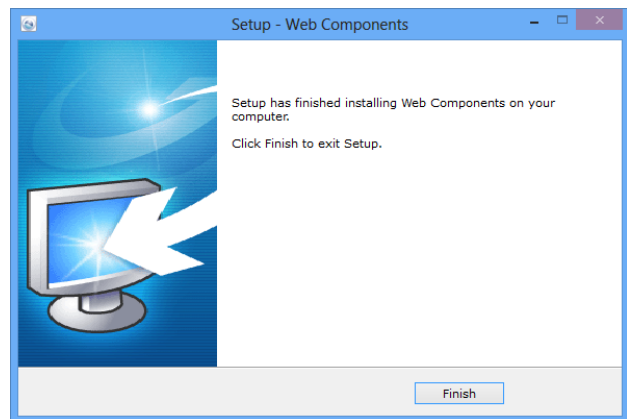

- 8** Open the browser and login again.

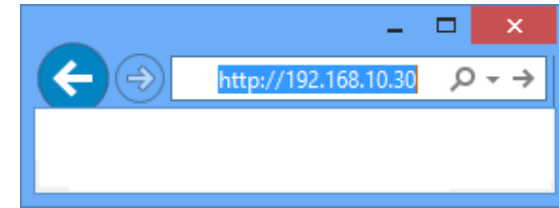

- 9** (Go to step 11 if you already changed your password with the setup CD). The TV-IP310PI will ask you to change your password from default setting. Please enter the new password twice and click **OK**. The password must be between 8 and 16 characters. (Alphanumeric: a-z, A-Z, 0-9, !, @, #, \$).

PLEASE ENTER YOUR NEW ADMINISTRATOR PASSWORD	
User Name	admin
Password
Confirm
OK	

- 10** Enter the user name **admin** and new password again to start secured session.

Windows Security	
iexplore	
The server 192.168.10.30 at TV-IP310PI requires a username and password.	
	User name
	Password
<input type="checkbox"/> Remember my credentials	
OK Cancel	

- 11 The Live View page will show up and begin streaming video.

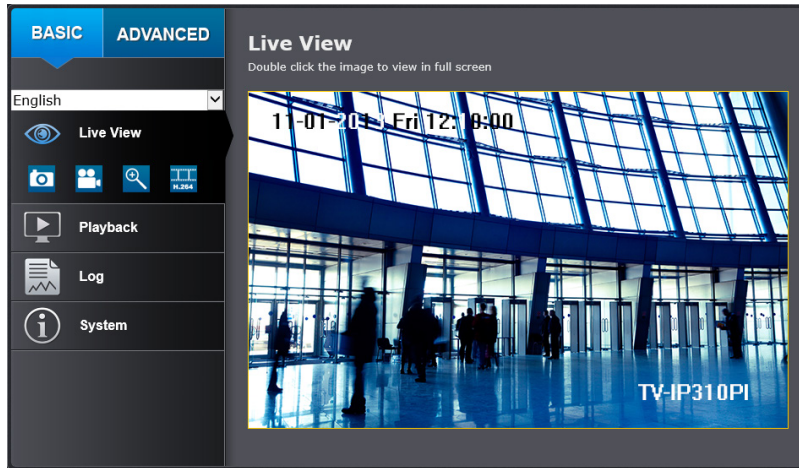

Logging-in to the Camera for the First Time (OS X)

- 1 Open the web browser on your computer. In the address bar, enter the IP address of the camera 192.168.10.30. (If you have a DHCP server on your network, the IP address will be assigned dynamically. For example, if you have a home gateway on your network and you plug-in the camera on the same network, then you can find the camera IP address on your home gateway.), and then press **Enter**.

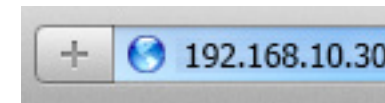

- 2 Enter the user name, **admin**, and the default password, **admin**, and then click **OK**.

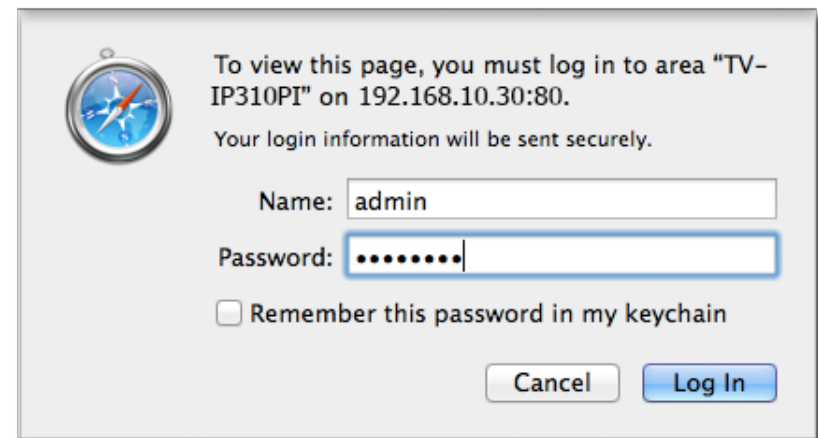

- 3 The camera management page will detect if you installed the camera video streaming plug-in or not. Click the link to download the plug-in from the TV-IP310PI camera.

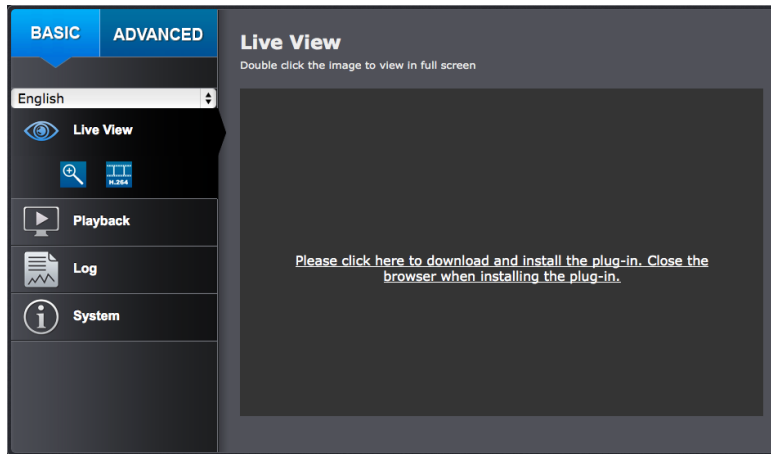

- 4 Quit your browser completely by **command-Click** on the browser icon and then click **Quit** before installing the plug-in.

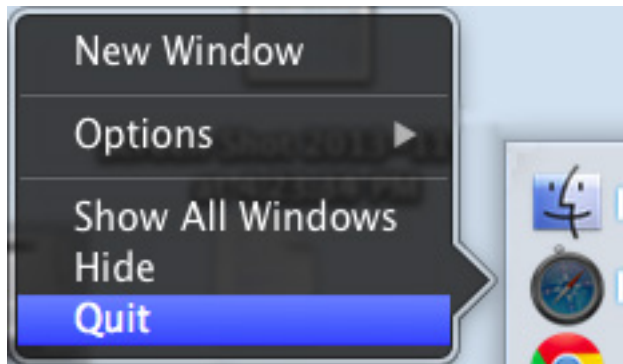

- 5 Go to the **Finder** and navigate to the **Download** folder. **Command-Click** the **WebComponents.pkg** and then click **Open**.

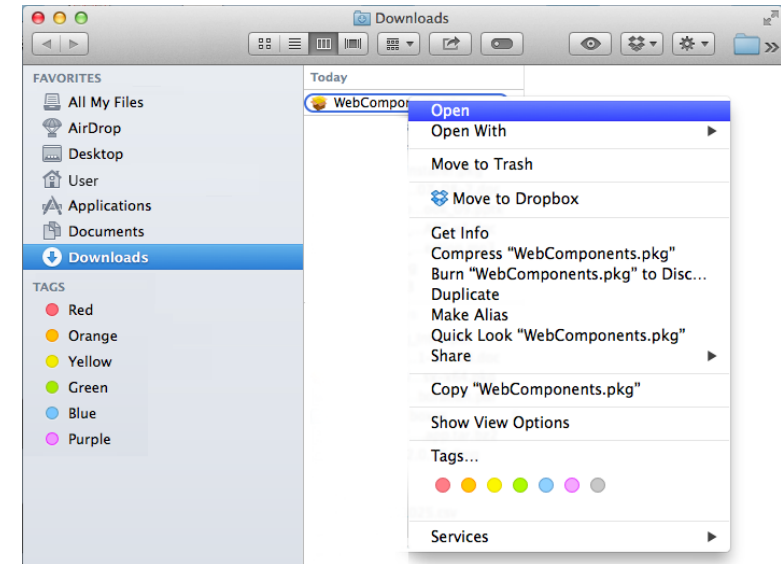

- 6 Click **Open** to start installation.

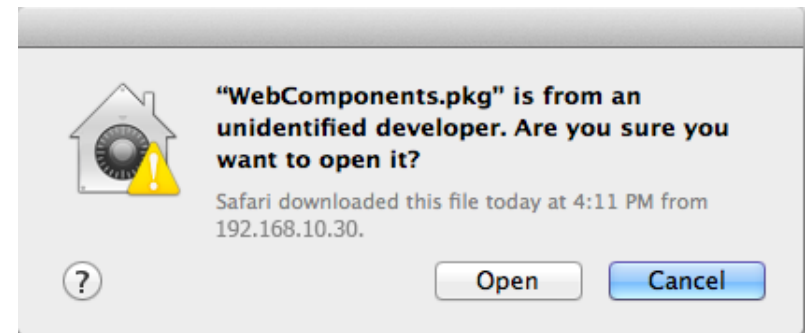

- 7 Click **Continue** to install the plug-in.

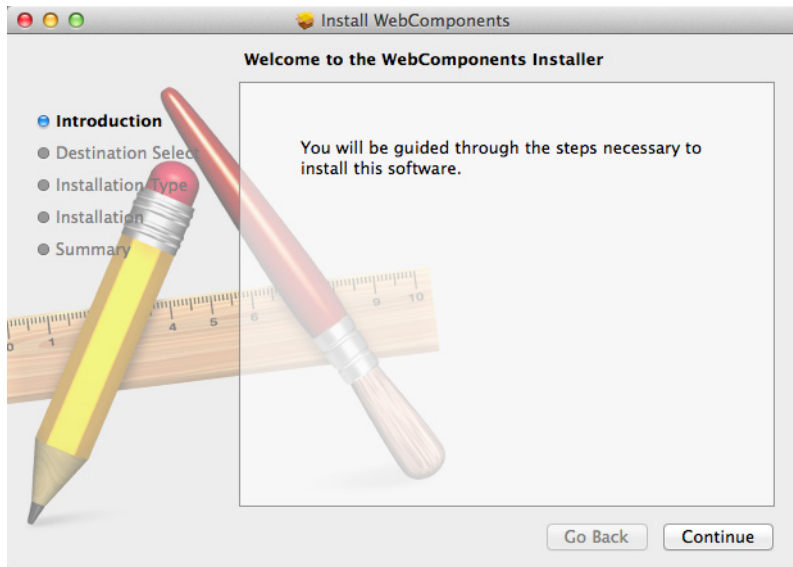

- 8 Select a destination to install the plug-in. Then click **Continue**.

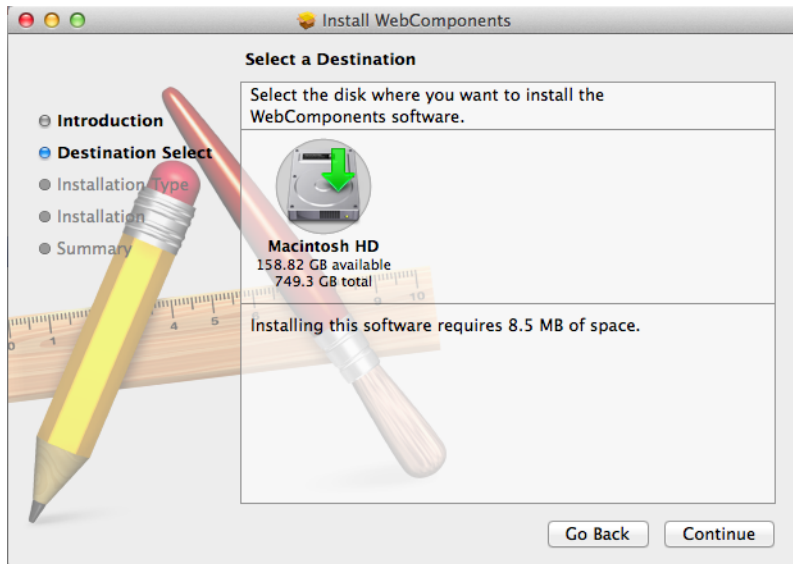

- 9 Use the default location and click **Install**.

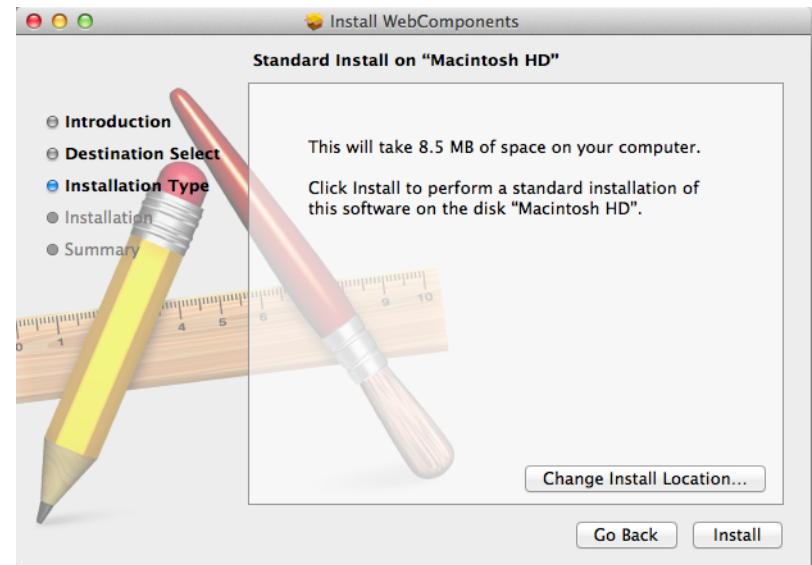

- 10 Enter your password and click **Install Software**.

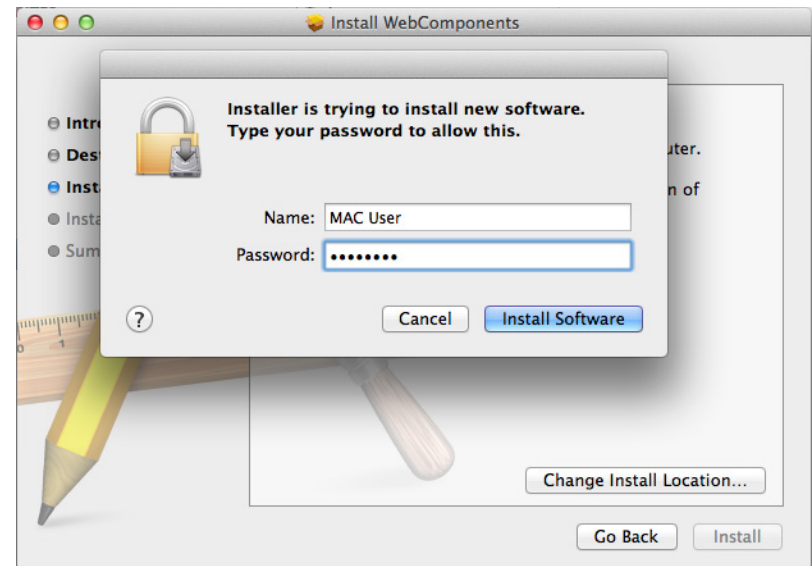

- 11 Installation will process automatically.

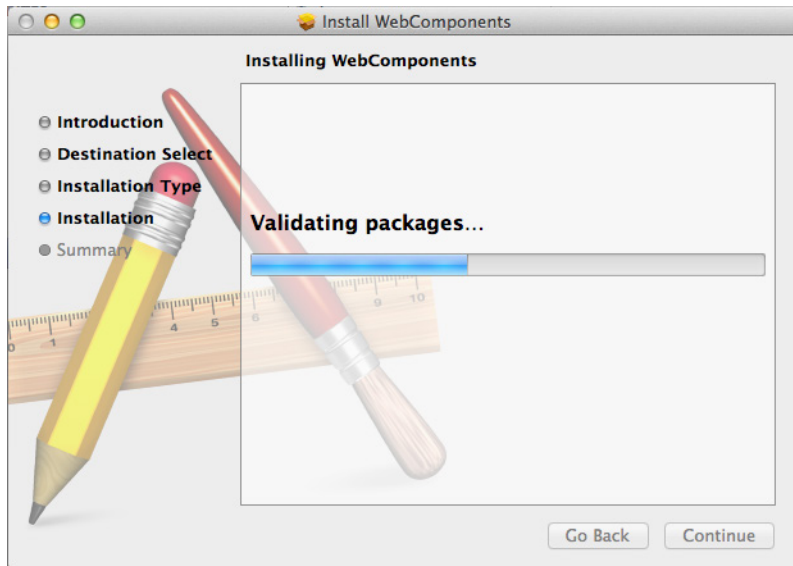

- 12 Click **Close** to exit the installation.

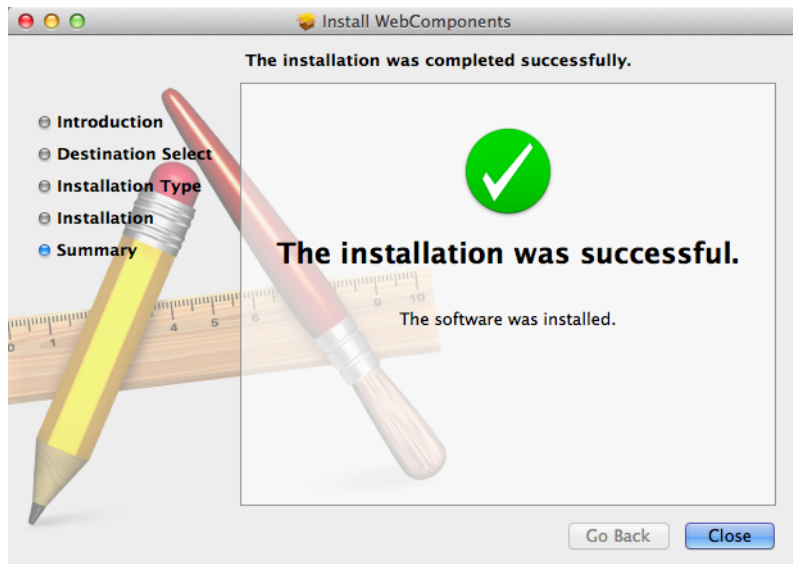

- 13 Open the browser and login again with the default IP 192.168.10.30 or the IP that was dynamically assigned by your router.

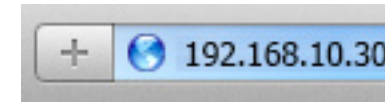

- 14 Enter the user name, **admin**, and the default password, **admin**, and then click **OK**.

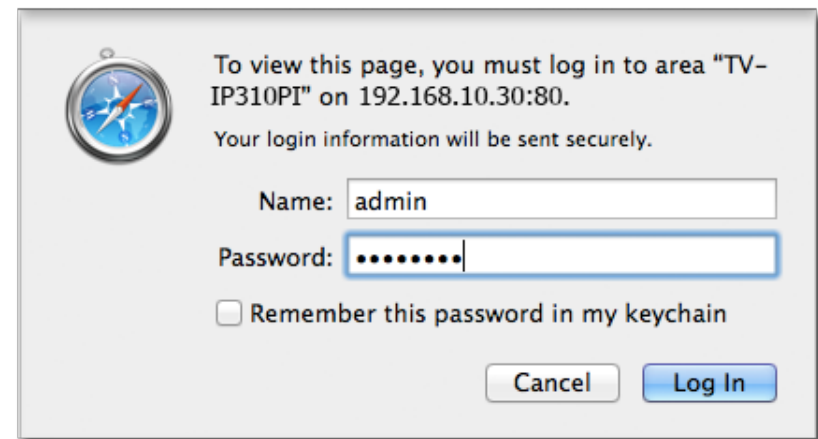

- 15 Click **Trust** (You'll have to do this again when your camera changes to a new IP address.)

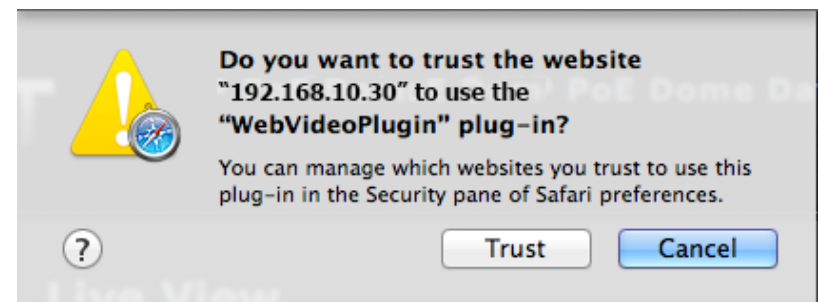

- 16** The TV-IP310PI will ask you to change your password from the default setting. Please enter the new password twice and click **OK**. The password must be between 8 and 16 characters. (Alphanumeric: a-z, A-Z, 0-9, !, @, #, \$).

PLEASE ENTER YOUR NEW ADMINISTRATOR PASSWORD

User Name	admin
Password
Confirm

OK

- 17** Enter the user name **admin** and new password again to start secured session.

 To view this page, you must log in to area "TV-IP310PI" on 192.168.10.30:80.
Your login information will be sent securely.

Name:

Password:

Remember this password in my keychain

Cancel **Log In**

- 18** The Live View page shows up and the video starts to stream.

BASIC **ADVANCED**

English

 Live View

 Playback

 Log

 System

Live View
Double click the image to view in full screen

11-01-2015 Fri 12:18:00



TV-IP310PI

Live View

After you log-in into the camera management page, you'll see the Live View page.

English **Multi-Language**
 Deutsch
 Español
 Français
 Русский

Change your preferred language anytime.

Snapshot

Click this icon to take a video snapshot.

Zoom

Click once to enable zoom. Then, click and drag the area on the picture to zoom in. Click once on picture for 100% zoom. Click the icon again to disable zoom. The zoom function works in full screen mode as well.

Recording

Click once to start recording. Click it again to stop recording. The status bar will indicate if it is in recording state or not.

H.264 MJPEG Video Stream

TV-IP310PI has two video streams: H.264 and MJPEG. Switch to view the different video streams by clicking this icon.

Full Screen Mode

Click the picture to view in full screen mode. Double click again or press escape key on your keyboard to exit full screen mode.

Status Bar

The status bar shows the status you are at, including enabled the zoom, recording video, and successfully taking a snapshot.

Where can I find saved files?

Videos and snapshots captured from Live View will save to your computer. See "Live View Settings" on page 28 for details.

Playback

You can playback the video recording on the network storage and download the video clip and snapshots to your local computer. (See “Network Storage” on page 49 for how to setup the storage.)

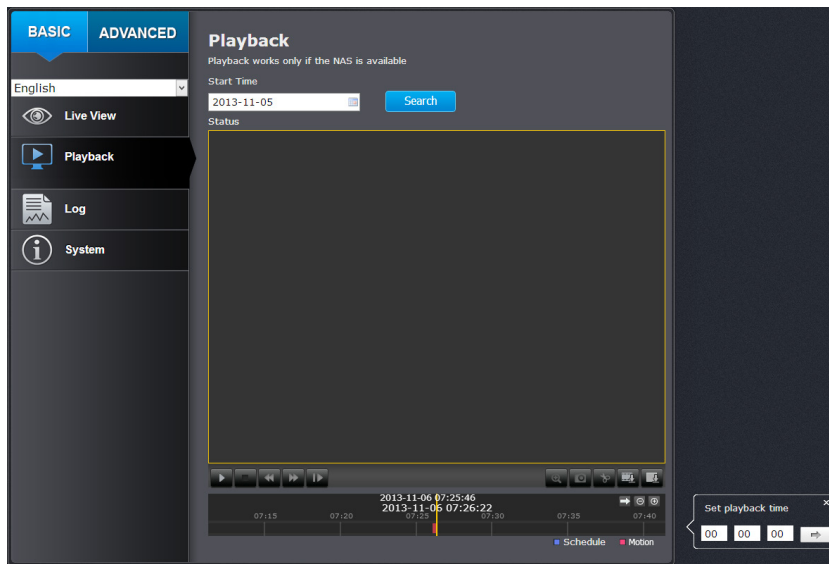

Search for video recordings

Click the date selection, then choose a date for the date range of your recording. Click **Search** to start searching.

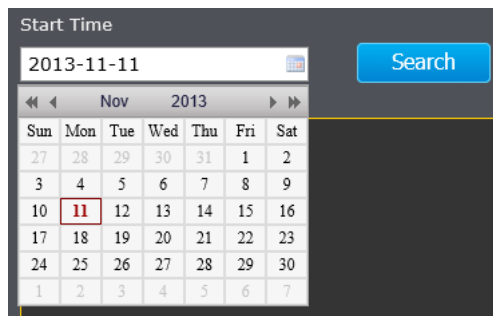

Time Line

There is a play back head in the center of the time line represented by a yellow vertical line. To look for a specific video recording, move the time line by clicking and dragging it. If the recording is short, zoom in by clicking button. Click to zoom out the time scale. If you know the exact time of the day you are looking for, click then enter the time you want to playback.

Different types of recordings are identified differently. The scheduled recordings are marked in blue, and the recordings triggered by motion detection are marked in red.

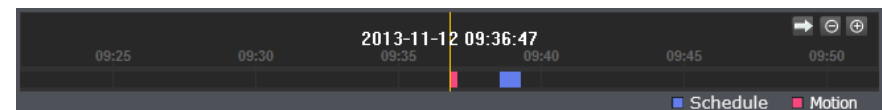

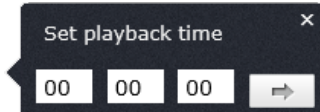



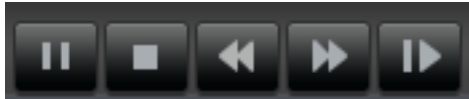

	Click and drag the time line to move your time manually.
	Click this button to zoom in the scale
	Click this button to zoom out of the scale
	Click this button to specify a specific time of the day.  then click to confirm selection and then click X to close this dialog box.

Playback

Use playback controls to play back the video recording.







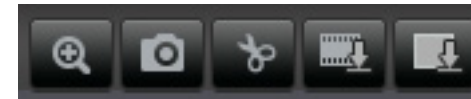

	Click this button to play the video.
	Click this button to pause video playback.
	Click this button to stop playback.
	Click this button increase playback speed*.
	Click this button decrease playback speed*.
	Click to playback video frame by frame. Click again for the next frame.

* There are 5 steps of playback speeds you can choose from: 1/4, 1/2, 1, 2, and 4 times of original speed.

Slice images from video playback

You can take snapshots from playback video or make new video clips from the video you are playing back.



	Click this button to enable zoom. Then click and drag on the video to define the area you want to zoom in. Click again to get back to 100% zoom. Double click to show video in full screen and press ESC on keyboard to exit full screen mode.
	Click this button to disable zoom.
	Click this button to take a snapshot of current playback.
	Click this button to start clipping a video from playback.
	Click this button to stop clipping a video from playback.

Where can I find saved files?

Videos and snapshots captured from Playback will save to your computer. See "Live View Settings" on page 28 for details.

Download sections of video

To save complete video sections or snapshots, you can download the files directly.

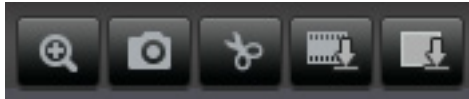

Click this button to download video sections.

No.	File Name	Start Time	End Time	File Size	Progress
<input checked="" type="checkbox"/>	1 ch01_0800000000000401	2013-11-06 07:26:02	2013-11-06 07:26:22	2 MB	Downloaded
<input type="checkbox"/>	2 ch01_0800000000000501	2013-11-06 07:37:00	2013-11-06 07:37:20	1 MB	

[Download](#)

Total 2 Items First Page Prev Page 1/1 Next Page Last Page

Check the time of the recording, select the videos you want to download, then click **Download**.

Download snapshots



Click this button to list snapshots to download

No.	File Name	File Date	File Size	Progress
<input type="checkbox"/>	1 ch00_08000000000301901	2013-11-12 09:28:49	107 KB	
<input type="checkbox"/>	2 ch00_08000000000302001	2013-11-12 09:28:50	65 KB	
<input type="checkbox"/>	3 ch00_08000000000302101	2013-11-12 09:28:51	57 KB	
<input type="checkbox"/>	4 ch00_08000000000302201	2013-11-12 09:28:52	52 KB	
<input type="checkbox"/>	5 ch00_08000000000302301	2013-11-12 09:28:53	52 KB	
<input type="checkbox"/>	6 ch00_08000000000302401	2013-11-12 09:28:54	53 KB	
<input type="checkbox"/>	7 ch00_08000000000302501	2013-11-12 09:28:55	53 KB	
<input type="checkbox"/>	8 ch00_08000000000302601	2013-11-12 09:28:56	53 KB	
<input type="checkbox"/>	9 ch00_08000000000302701	2013-11-12 09:28:57	53 KB	
<input type="checkbox"/>	10 ch00_08000000000302801	2013-11-12 09:36:54	181 KB	
<input type="checkbox"/>	11 ch00_08000000000302901	2013-11-12 09:36:55	58 KB	
<input type="checkbox"/>	12 ch00_08000000000303001	2013-11-12 09:36:56	54 KB	
<input type="checkbox"/>	13 ch00_08000000000303101	2013-11-12 09:36:57	52 KB	
<input type="checkbox"/>	14 ch00_08000000000303201	2013-11-12 09:36:58	52 KB	
<input type="checkbox"/>	15 ch00_08000000000303301	2013-11-12 09:36:59	52 KB	
<input type="checkbox"/>	16 ch00_08000000000303401	2013-11-12 09:37:00	52 KB	
<input type="checkbox"/>	17 ch00_08000000000303501	2013-11-12 09:37:01	52 KB	
<input type="checkbox"/>	18 ch00_08000000000303601	2013-11-12 09:37:02	52 KB	
<input type="checkbox"/>	19 ch00_08000000000303701	2013-11-12 09:39:05	54 KB	
<input type="checkbox"/>	20 ch00_08000000000303801	2013-11-12 09:39:06	55 KB	
<input type="checkbox"/>	21 ch00_08000000000303901	2013-11-12 09:39:07	52 KB	
<input type="checkbox"/>	22 ch00_08000000000304001	2013-11-12 09:39:08	52 KB	
<input type="checkbox"/>	23 ch00_08000000000304101	2013-11-12 09:39:09	53 KB	
<input type="checkbox"/>	24 ch00_08000000000304201	2013-11-12 09:39:10	53 KB	
<input type="checkbox"/>	25 ch00_08000000000304301	2013-11-12 09:39:11	52 KB	
<input type="checkbox"/>	26 ch00_08000000000304401	2013-11-12 09:39:12	53 KB	
<input type="checkbox"/>	27 ch00_08000000000304501	2013-11-12 09:39:13	53 KB	

Total 27 Items First Page Prev Page 1/1 Next Page Last Page

Motion ▼

Start Time
2013-11-12 00:00:00

End Time
2013-11-12 23:59:59

[Search](#)

[Download](#)

Schedule Motion Select the type of event that triggered the snapshots. Choose the **Start Time** and **End Time**. Then, click **Search** to find the snapshot list. Check the time of the snapshot, and then select the snapshots you want to download, then click **Download**.

Where can I find saved files?

Videos and snapshots will save to your computer. See "Live View Settings" on page 28 for details.

Log

The log of the TV-IP-310PI will be saved on the network storage. You can search the relevant records and save to your local computer. (See “Network Storage” on page 49 for how to setup the storage.)

Search for logs

Click the type of log and then the **Start Time** and **End Time**. Click **Search** to start searching.

Total 129 Items [First Page](#) [Prev Page](#) 1/2 [Next Page](#) [Last Page](#)

Click **First Page**, **Prev Page**, **Next Page**, and **Last Page** to show the logs. Click **Save Log** to save the logs to your computer.

Where can I find saved files?

After you click the **Save Log**, the logs will save to your computer. See “Live View Settings” on page 28 for details.

System Information

System Information page shows the TV-IP310PI's basic information. Click **System** then click **System Info** to show the page.

System Information

BASIC INFORMATION

Device Name : TV-IP311PI

Firmware Version : V5.0.0 131028

Mac Address : 8c:e7:48:df:c1:05

System Time : 2013-10-30T04:30:07

NETWORK INFORMATION

IP Address : 10.10.10.1

Subnet Mask : 255.255.255.0

Default Gateway : 10.10.10.254

Primary DNS : 10.10.10.254

Secondary DNS :

Basic Information

Device Name:	Human readable device name for easy identification.
Firmware Version:	Firmware version
MAC Address:	The MAC address of Ethernet Interface
System Time:	The system time setup in the camera. Keeping this time correct is important for recording, scheduled control and logging accurately.

Network Information

IP Address:	IP address of the TV-IP310PI
Subnet Mask:	Network range of IP address
Default Gateway:	The default route going from the TV-IP310PI subnet.
Primary DNS:	Primary DNS server address
Secondary DNS:	Secondary DNS server address

System Configuration

Device Settings

Setup your camera name and location for easy identification. This camera name will also be recognized by other network camera software as the name of this camera.

OSD, On Screen Display, the camera name is setting up here as well.

Names

Camera Name:	Name of the camera. The camera name setup here can be discovered by other network camera software and OSD, On Screen Display. The default is the model number: TV-IP310PI
Location:	Label where you installed this camera

Authentication

RTSP:	TV-IP310PI's video stream can be accessed with RTSP, Real Time Streaming Protocol. Only the administrator and users can view this video stream. Un-checking this box will allow everyone access to this video stream without authentication. Default: checked.
HTTP:	TV-IP310PI can be accessed via password protected web management interface. Un-checking this box will allow anyone to access this camera and change its settings.

User Accounts

You can setup up to 16 user accounts to access the camera's video stream with a web browser or real time video stream (RTSP). Only one administrator account can be setup to configure the TV-IP310PI and cannot be deleted.

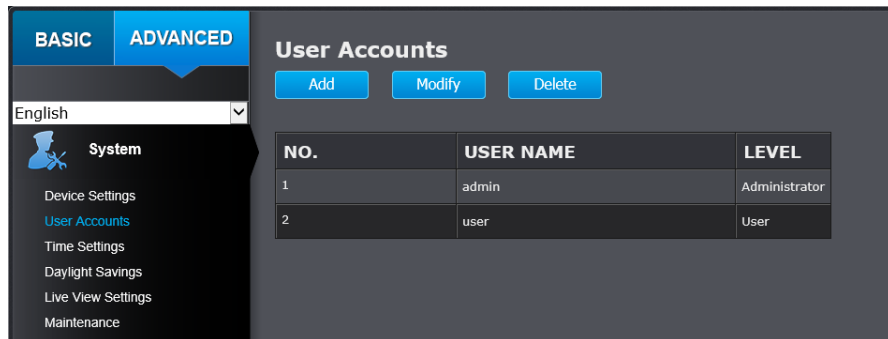

User Accounts

Add:	Click Add button to add one user account
Modify:	To change a user's name and password, highlight the user by clicking on it. Then, click Modify button. You can change the user's name and password. You can also change the administrator's password here. But, the administrator's name is fixed, you cannot change that.

MODIFY USER

User Name	user x
Password	*****
Confirm	*****
<input type="button" value="OK"/> <input type="button" value="Cancel"/>	

Click **OK** to save the changes.

Time Settings

The accuracy of the system clock is important for scheduling and accurate logging. You can synchronize the system time with your computer, or automatically check the time accuracy with a network time server (NTP server).

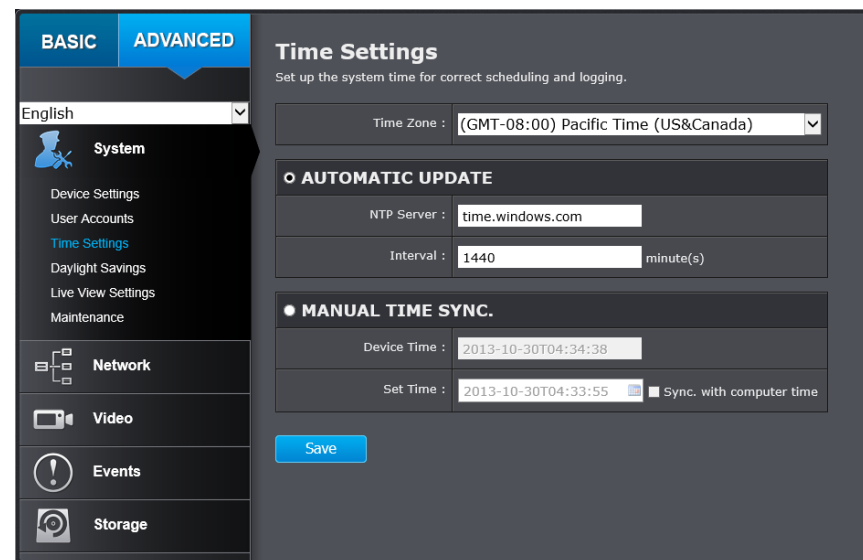

Automatic Update

NTP Server:	Specify a time server (NTP server) to synchronize with. (e.g. pool.ntp.org)
Interval:	The time interval that the TV-IP310PI will synchronize the time with NTP server. Default: 1440 minutes (24 hours).

Click **Save** to save the changes.

Manual Time Sync.

Device Time:	The system time of this camera.
Set Time:	Click the calendar icon and manually select the date. Check the Sync. with computer time to copy the time from your computer.

Click **Save** to save the changes.

Daylight Savings

Setup daylight settings for system time.

Automatic Update

Enable DST:	Check this box if your time zone has daylight savings.
Start Time:	Enter the date that daylight savings starts
End Time:	Enter the date that daylight savings ends
DST Bias	Enter how much time the daylight saving adjusted by daylight savings.

Click **Save** to save the changes.

Live View Settings

Setup daylight settings for system time.

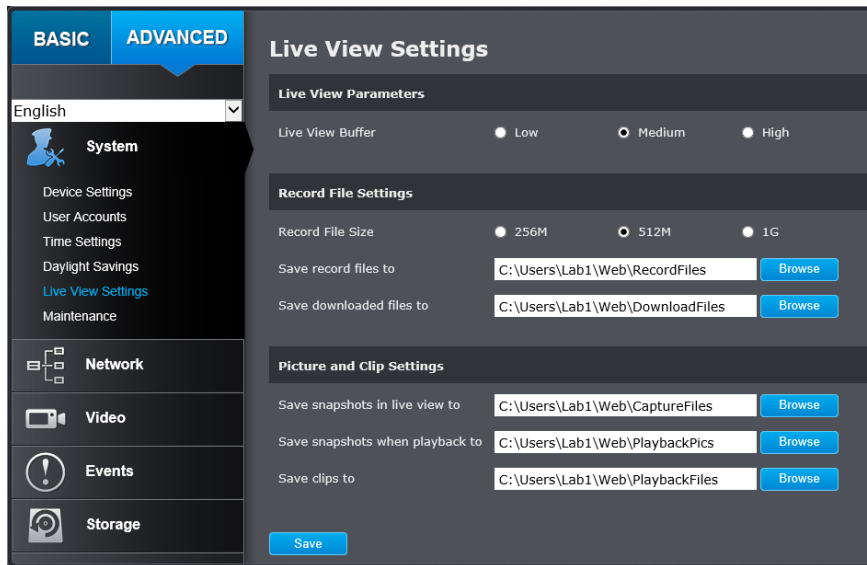

Live View Parameters

Live View Buffer:	Configure the buffer size for live view video stream. With low buffer size setting, you can get real-time video stream, but the video may be stop and go if the network is congested. With high buffer setting, you can have smooth video streaming, but the video is delayed from the time happening. Medium size can have moderate video stream smoothness and time delay.
--------------------------	------------------------------------------------------------------------------------------------------------------------------------------------------------------------------------------------------------------------------------------------------------------------------------------------------------------------------------------------------------------------------

Record File Settings

Record file size:	This size of live view video recording. You can choose 256MB, 512MB, or 1GB a file. Smaller file size is good for many short recordings.
Save record files to:	By default, files will be saved under your user name, and under the Web/RecordFiles. Click Browse and choose a new destination if you want to save the file somewhere else.
Save downloaded files to:	By default, files will be saved under your user name, and under the Web/DownloadFiles. Click Browse and choose a new destination if you want to save the file somewhere else.

Picture and Clip Settings

Save snapshots in live view to:	By default, files will be saved under your user name, and under the Web/CaptureFiles. Click Browse and choose a new destination if you want to save the file somewhere else.
Save snapshots when playback to:	By default, files will be saved under your user name, and under the Web/PlaybackPics. Click Browse and choose a new destination if you want to save the file somewhere else.
Save clips to:	By default, files will be saved under your user name, and under the Web/PlaybackFiles. Click Browse and choose a new destination if you want to save the file somewhere else.

Click **Save** to save the changes.

Maintenance

You can do the camera system maintenance on this page.

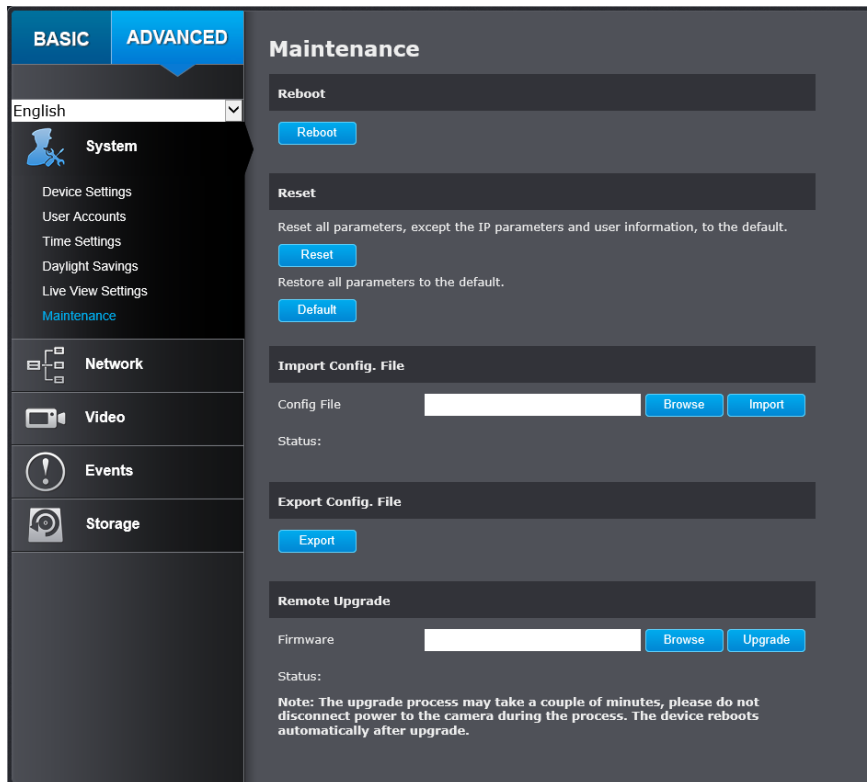

Reboot

Reboot:	Click this button to reboot this camera.
----------------	------------------------------------------

Reset

Reset:	Reset all camera parameters, except the IP parameters and user information.
Default:	Load complete factory default to the camera.

Import Config. File

Config. File:	To load previously saved configurations, click Browse to find the configuration file and then click Import .
Status:	Shows the status in loading configuration file.

Click **Save** to save the changes.

Export Config. File

Export:	Click Export to download configuration file. The file will be downloaded to the Download folder by default.
----------------	---------------------------------------------------------------------------------------------------------------------------

Remote Upgrade

Firmware:	Click Browse to find the latest firmware and then click Upgrade* .
Status:	Shows the status in firmware upgrade.

* TRENDnet may periodically release firmware upgrades that might add features or fix problems associated with your TRENDnet model and version. To find out if there is a firmware upgrade available for your device, please check your TRENDnet model and version using the link.

<http://www.trendnet.com/downloads/>

1. If a firmware upgrade is available, download the firmware to your computer.
2. Unzip the file to a folder on your computer.
3. Read the firmware upgrade instruction for specific version update information.
4. Log into the TV-IP301PI
5. Getting to this **Maintenance** page to upgrade firmware.

Network Settings

TCP/IP

Setup your basic IPv4 and IPv6 network settings on this page.

The screenshot shows the 'TCP/IP Network Settings' page in the device's web interface. The page is divided into 'BASIC' and 'ADVANCED' tabs, with 'ADVANCED' selected. The left sidebar contains navigation menus for 'System', 'Network', 'Video', 'Events', and 'Storage'. The 'Network' menu is expanded, showing 'TCP/IP' as the active section. The main content area is titled 'TCP/IP Network Settings' and includes a sub-header 'NETWORK INTERFACE' with a description: 'Setup your camera to get network address manually or dynamically.' Below this, there are sections for 'IPv4' and 'IPv6' settings. The 'IPv4' section includes fields for DHCP (checked), IPv4 Address (10.10.10.1), Subnet Mask (255.255.255.0), Default Gateway (10.10.10.254), and Multicast Address. The 'IPv6' section includes a dropdown for IPv6 Mode (set to 'Route Advertisement'), a 'View Rout...' button, IPv6 Address (fe80::8ee7:48ff:fedf:c105), Prefix Length (64), and Default Gateway. A 'Save' button is located at the bottom left of the settings area.

Network Interface

MAC Address:	Click this button to reboot this camera.
Duplex and Speed:	Choose one of the Ethernet duplex and speed to match your network. Default: auto.
<div style="border: 1px solid black; padding: 2px;"> 10M Half-dup 10M Full-dup 100M Half-dup 100M Full-dup Auto </div>	
MTU:	Maximum transmission unit. The maximum byte size Ethernet data field.
Primary DNS:	Enter your first IPv4 or IPv6 DNS server address
Secondary DNS:	Enter your second IPv4 or IPv6 DNS server address

IPv4

DHCP:	Check this box if the IP address is assigned by DHCP server.
IPv4 Address:	Load complete factory default to the camera.
Subnet Mask:	Network range of the subnet
Default Gateway:	The default route going further from TV-IP310PI IPv4 subnet.
Multicast Address:	Multicast address for video streaming.

IPv6

IPv6 Mode:	Choose Manual, DHCP, or Route Advertisement. Click View Route Advertisement to find a route advertisement.
<div style="border: 1px solid black; padding: 2px;"> Manual DHCP Route Advertisement </div>	
IPv6 Address:	IPv6 address of TV-IP310PI.
Prefix Length:	Length of network prefix
Default Gateway:	The default route going further from TV-IP310PI IPv6 subnet.

Port

You can change the service ports number of TV-IP-310PI or disable RTSP or HTTPS services.

Port Numbers

HTTP Port:	The default web access port. You can change the port number. However, you cannot disable the web service. The default port number is 80.
RTSP Port:	The Real-Time Streaming Protocol port for video streaming. You can change the port number or disable the service by uncheck the box. The default port number is 554.
HTTPS Port:	The secured web service port. You can change the port number, or you can disable the service by uncheck the box. The default port number is 443.

Click **Save** to save the changes.

DDNS

Dynamic Domain Name Service, DDNS, allows you to find your camera from the Internet with an easy to remember domain name.

Port Numbers

Enable DDNS:	Check this box to enable DDNS Service.
DDNS Type: NO-IP IPServer DynDNS NO-IP HiDDNS	Select a DDNS service provider.
Server Address:	Enter the DDNS server address.
Domain:	Enter your registered domain name on selected DDNS service.
User Name:	Enter the account name.
Password:	Enter the password.
Confirm:	Enter the password again.

Click **Save** to save the changes.

PPPoE

Setup PPPoE (ADSL) connection to connect your camera with your ISP, Internet Service Provider.

PPPoE (ADSL)

Enable PPPoE:	Check this box to enable PPPoE connection.
Dynamic IP:	The IP address provided by ISP
User Name:	Enter the account name.
Password:	Enter the password.
Confirm:	Enter the password again.

Click **Save** to save the changes.

SNMP

SNMP Settings allows you to assign the contact details, location, community name and trap settings for SNMP. This is a networking management protocol used to monitor network-attached devices. SNMP allows messages (called protocol data units) to be sent to various parts of a network. Upon receiving these messages, SNMP compatible devices (called agents) return data stored in their Management Information Bases.

SNMP V1/V2

Enable SNMPv1:	Check this box to enable SNMP v1 management.
Enable SNMPv2c:	Check this box to enable SNMP v2c management.
Read SNMP Community:	Specify the password for access the SNMP community for read only access
Write SNMP Community:	Specify the password for access to the SNMP community with read/write access
Trap Address:	Specify the IP address for the SNMP trap community
Trap Port:	Specify the port number for the SNMP trap community
Trap Community:	Specify the name of SNMP trap community

SNMP V3

Enable SNMPv3:	Check this box to enable SNMP v3 management.
Read User Name:	SNMP v3 member user name
Security Level:	Choose one of the security levels. <div style="border: 1px solid black; padding: 2px; width: fit-content; margin: 5px auto;"> Authentication and Privacy Authentication only Privacy only </div>
Authentication Algorithm:	Choose the authentication method to verify the source of information: MD5 or SHA.
Authentication Password:	Specify the authentication password between 8 to 32 letters.
Private-key Algorithm:	Choose the privacy key to encrypt SNMP messages: DES or AES.
Private-key Password:	Specify the privacy key between 8 to 32 letters.

Write User Name:	SNMP v3 manager user name
Security Level:	Choose one of the security levels. <div style="border: 1px solid black; padding: 2px; width: fit-content; margin: 5px auto;"> Authentication and Privacy Authentication only Privacy only </div>
Authentication Algorithm:	Choose the authentication method to verify the source of information: MD5 or SHA.
Authentication Password:	Specify the authentication password between 8 to 32 letters.
Private-key Algorithm:	Choose the privacy key to encrypt SNMP messages: DES or AES.
Private-key Password:	Specify the privacy key between 8 to 32 letters.

SNMP Other Settings

SNMP Port:	SNMP service port number.
-------------------	---------------------------

Click **Save** to save the changes.

802.1X

Setup 802.1X for remote authentication service.

802.1X Authentication

Enable IEEE 802.1X:	Check this box to enable 802.1X authentication service.
EAPOL version:	Extensible Authentication Protocol (EAP) over LAN (EAPoL). Choose version 1 or 2. This version number much match to your 802.1X service EAPOL version.
User Name:	Enter the account name.
Password:	Enter the password.
Confirm:	Enter the password again.

Click **Save** to save the changes.

IP Address Filter

Set up a list of clients allow only the clients on the list to access this camera or to reject clients on the list from access this camera.

Enable IP Address Filter:	Check this box to enable IP address filtering service.
IP Address Filter Type:	Choose Forbidden to ban the listed IP addresses or Allowed to allow listed host to access this camera.
Add:	Click Add to add a user account
Modify:	To modify an entry on the list, highlight the entry by clicking on it. Then, click the Modify button. 
Delete:	To delete an entry on the list, highlight the entry by clicking on it. Then, click Delete .
Clear:	To clear all entries, click Clear .

Click **Save** to save the changes.

QoS, Quality of Service

Setup traffic prioritization to help smooth out the video stream. You can set the Differentiated Services Code Point (DSCP) bits on outgoing data streams. The QoS capable network device will forward different data in different priorities. The meaning of the value is different in different DiffServ domains. Consult your network manager for the setup details.

Video/Audio DSCP:	Enter Video/Audio DSCP. Default: 0.
Event/Alarm DSCP:	Enter Event/Alarm DSCP. Default: 0.
Management DSCP:	Enter Management DSCP. Default: 0.

Click **Save** to save the changes.

UPnP

Universal Plug-and-Play is a device discovery protocol set. It allows your camera to easily be found, for example, on a Windows operation system.

UPnP

Enable UPnP:	Check this box to enable UPnP connection.
Friendly Name:	The name that will be appeared when searched.

Port Mapping

Enable Port Mapping:	Check this box to enable UPnP connection.
Port Mapping Mode:	Choose Manual or Auto port mapping.
External Port:	Choose the port number for mapping.

Click **Save** to save the changes.

Video Settings

Video Format

Adjust the format of video.

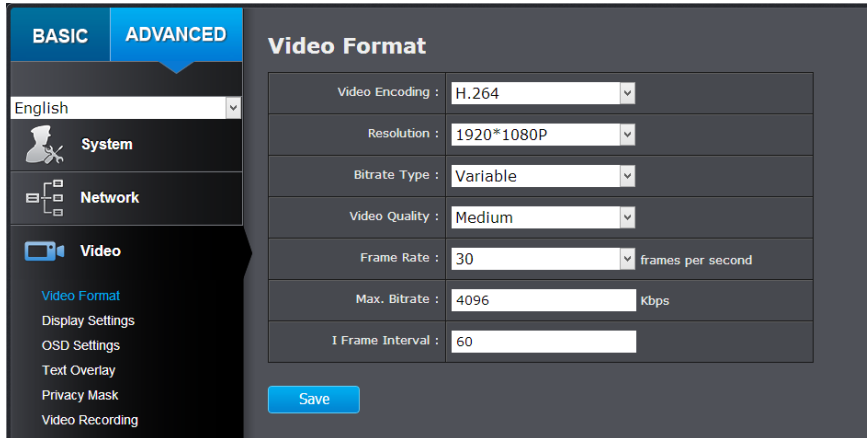

Video Encoding:	Choose the video stream you want to modify. H.264 and MJPEG videos are always streaming and can be configured separately.	
	H.264	MJPEG
Resolution:	1280*720P 1920*1080P 2048*1536	320*240 352*240 704*480
Bitrate Type:	Variable Constant	Choose between variable bit rate or constant bit rate for video compression. The default is variable rate.
Video Quality:	Lowest Lower Low Medium Higher Highest	Choose the video quality. The default is medium quality.

Frame Rate:	30 1/16 1/8 1/4 1/2 1 2 4 6 8 10 12 16 20 15 18 22	Choose the capturing frame rate. The default value is 30 frames per second. Reduce the frame rate to reduce the capture file size.
Max. Bitrate:	Choose the maximum video sampling bit rate. Default: 4096	
I Frame Interval	An I Frame is a frame that records a complete picture. Frames between I frames, (P frame or B frame) only records the image differences between two frames. Choose the I Frame Interval here. The default is 60.	

Click **Save** to save the changes.

Display Settings

Adjust video image quality, lightness, and color settings here.

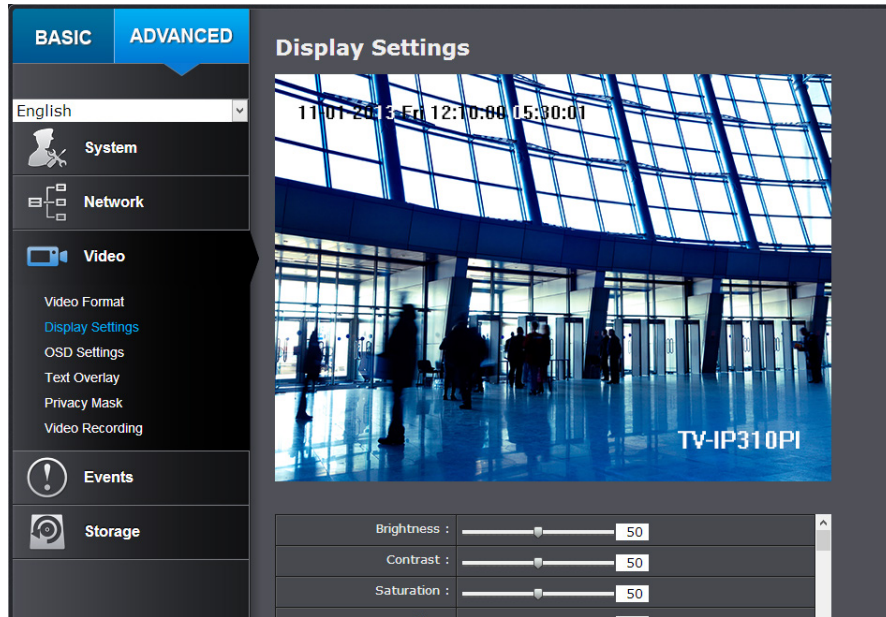

Brightness:	Use the slider or enter a number (0-100) to adjust the image brightness. Default: 50
Contrast:	Use the slider or enter a number (0-100) to adjust the image contrast. Default: 50
Saturation:	Use the slider or enter a number (0-100) to adjust the color saturation. The greater number means the color will be more saturated. Default: 50
Hue:	Use the slider or enter a number (0-100) to adjust the color shade. Default: 50
Sharpness:	Use the slider or enter a number (0-100) to adjust the image sharpness. Default: 50

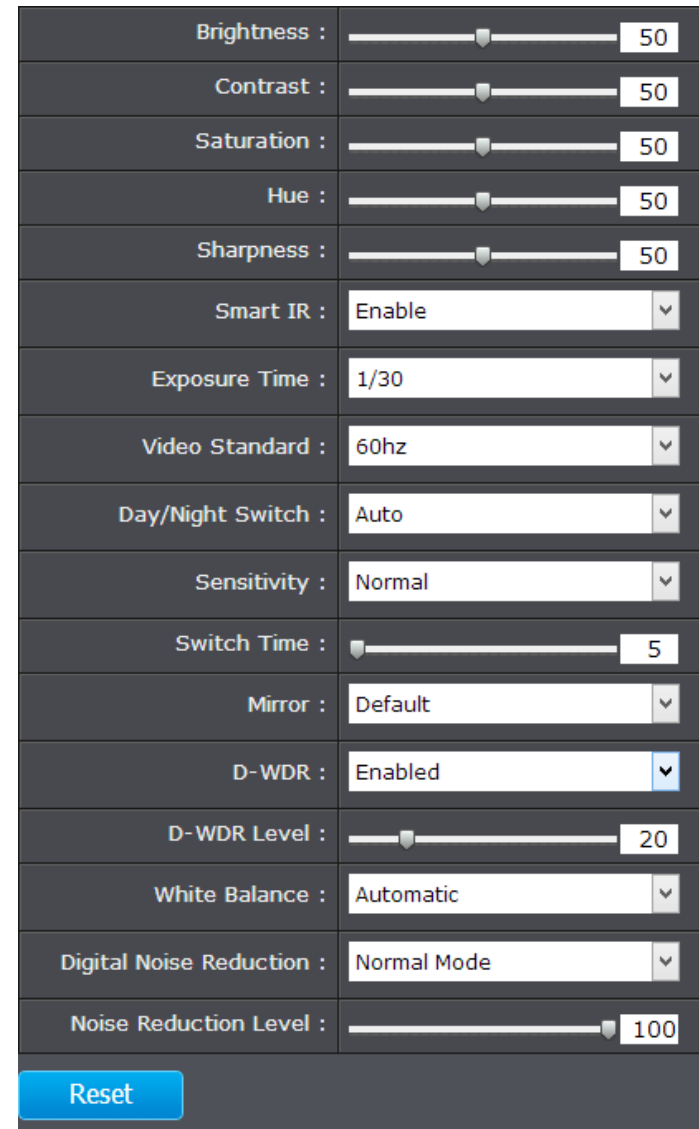

Light sensitivities

Smart IR:	Smart IR can adjust the strength of infra red lights at night depending on the distance of an object to maintain the maximum IR light distance and while maintaining a clear picture when object is close by. Default: On.
Exposure Time:	<div data-bbox="310 456 570 715"> <ul style="list-style-type: none"> 1/3 1/6 1/12 1/30 1/60 1/120 1/250 1/500 1/750 1/1000 1/2000 1/4000 1/10000 1/100000 </div> <div data-bbox="576 456 970 715"> <p>Adjust this value for exposure time for each picture. You can choose a value between 1/3 second to 1/100,000 second. The default value is 1/30 second exposure time for each picture.</p> </div>
Video Standard:	This is the base frequency for the video refresh rate. It is recommended to set to the same frequency of your local video standard (NTSC: 60, PAL: 50). Default: 60Hz.
Day/Night Switch:	<div data-bbox="310 847 570 967"> <ul style="list-style-type: none"> Day Night Auto Schedule </div> <div data-bbox="576 847 970 1121"> <p>Choose whether you want the camera to be set to the day mode (color video) or night mode (IR enhanced black/white video). You can manually set it to day mode or night mode, adjust by lighting (Auto), or pre-define schedule.</p> </div> <div data-bbox="310 1129 970 1369"> <p>Auto:</p> <ul style="list-style-type: none"> • Sensitivity: The light sensor sensitivity. • Switch Time: The time delayed to switch between modes. Longer switch time can prevent unnecessary mode flipping if an object is blocking the light source temporarily. Range: 5-120 seconds, default: 5 seconds. </div>

Schedule:

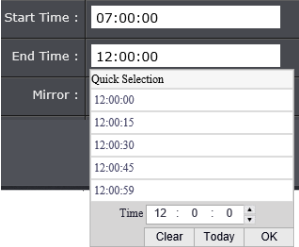

Use quick selection or enter the time down below. Click **OK** to confirm the time you want to set.

- **Start Time:** The start time for day mode.
- **Stop Time:** The start time for day mode.

Position adjustments

Mirror:

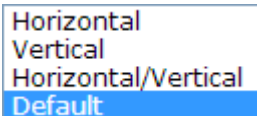

Choose either horizontal, vertical or both to adapt to the physical position of installation.

Image adjustments

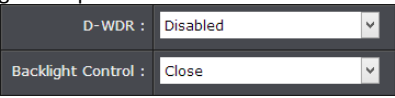
Mirror:	<p>Horizontal Vertical Horizontal/Vertical Default</p>	Choose either horizontal, vertical or both to adapt to the physical position of installation.
Back Light Compensation and Digital Wide-Dynamic-Range:	<p>Back light compensation: Setup a fixed light source position to compensate and adjust the image in the dark.</p> <p>Close Up Down Left Right Center</p> <p>* By default, the the D-WDR is enabled. Please disable D-WDR to set up back light compensation.</p>  <p>D-WDR: Digital Wide Dynamic Range compensates for the dark area dynamically*.</p> <ul style="list-style-type: none"> • D-WDR Level: The level of compensation. Range: 0-100%, default: 20%. 	Choose the area that you want to enhance (dark area, not light source).
White Balance:	<p>Automatic Locked Incandescent Lamp(3000K) Warm Light Lamp(4000K) Natural Light(5500K) Fluorescent Lamp(6500K)</p>	Choose a color temperature as the white color and compensate the color on the whole image.
Digital Noise Reduction:	<p>Disabled Normal Mode</p> <p>Enable or disable noise reduction.</p> <p>Noise Reduction Level: Adjust the effect of digital noise reduction. Range: 0-100%, default : 100%</p>	

Click **Reset** to reset the display setting changes.

On Screen Display Settings

You can display the camera name and the time the video is shooting on the screen.

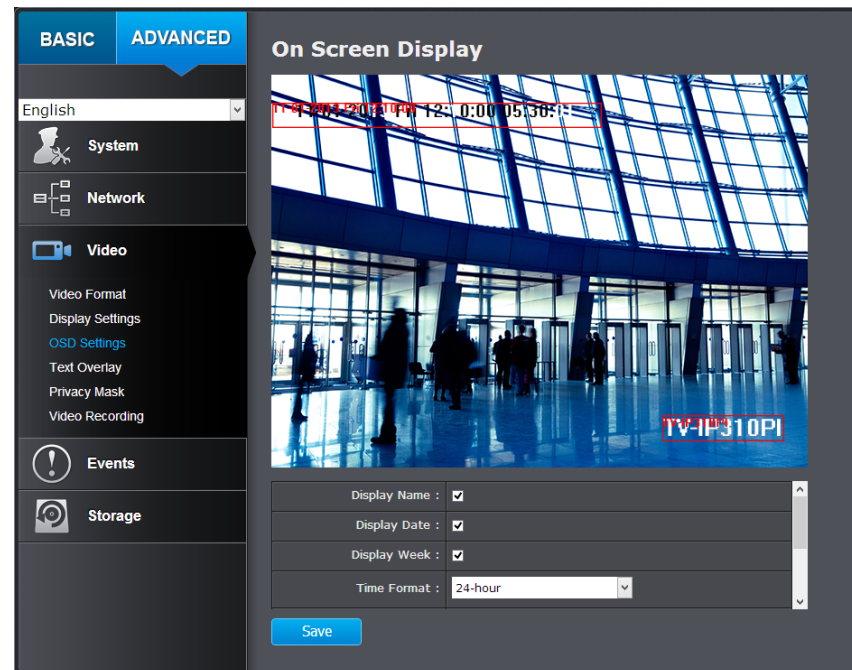

Display Name:	Check this box to display the product name that was setup in the device settings (refer to page 25 to change the device name.)
Display Date:	Check this box to display system time.
Display Week:	Check this box to display time of the week.
Time Format:	Select 12 or 24 hours time format.

Move the red box to position the text display. Click **Save** to save the display settings.

Text Overlay

Display extra information on the screen over the image.

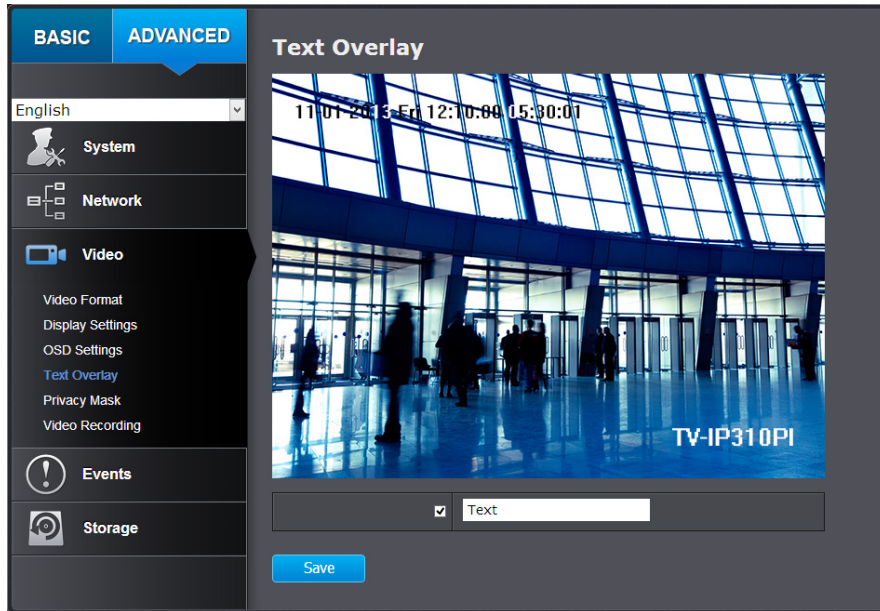

Check Box:	Check this box to enable text overlay.
Text Field:	Enter the text you want to display. You can enter your local language if you want. The text field allows maximum 44 English letters or 20 non-English characters.

Move the red box to position the display positions.
Click **Save** to save the changes.

Privacy Mask

Create a masking area to keep your privacy. You can create up to four independent masking areas by clicking and dragging on the screen.

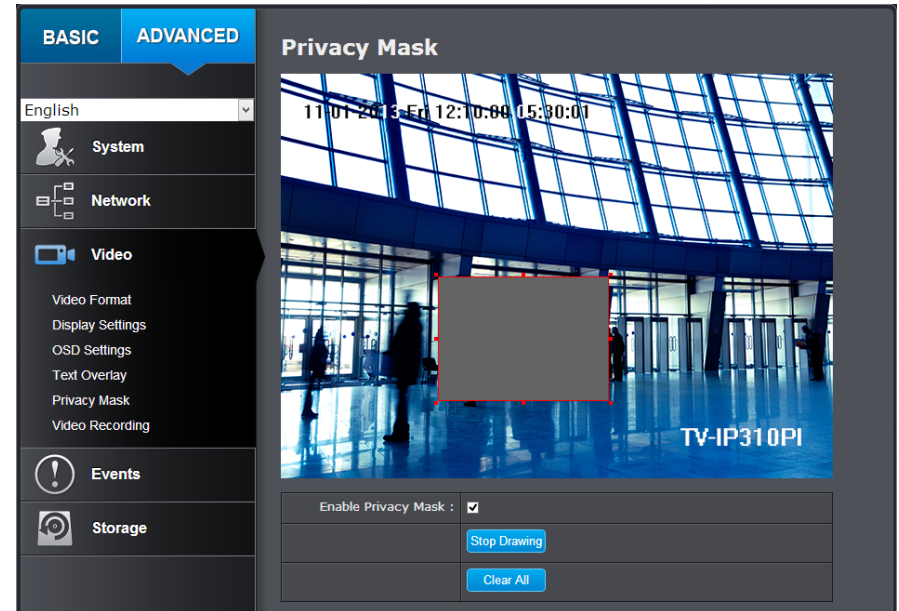

Enable Privacy Mask:	Check this box to enable privacy masking.
Stop Drawing:	Click this button to stop drawing.
Clear All:	Click this button to clear all the masking areas.

Click **Save** to save the changes.

Video Recording

Pre-record:	Recording time before trigger event.
Post-record:	Recording time after trigger event.
Overwrite:	Select Yes to allow older recordings to be overwritten.
Enable Record Schedule:	Check this box and then click Save to enable video recording.

Click **Save** to save the changes.

Edit: Click **Edit** to edit the recording schedule.

1. Select day of the week you want to edit the schedule.
2. Select **All Day** or **Customized** schedule of the day.
3. Set the time period and the event you want to trigger the video recording **continuous** (always recording) or **motion detection**.
4. Click **Copy to Week** if you want the same daily schedule everyday. Or, you can select other day of the week and click **Copy** to copy the schedule of the day to other days.
5. Click another day of the week by clicking on its tab to set the next schedule. Click **OK** when you have finished your settings.

Events

Motion Detection

Set up how the motion detection event will be triggered and what actions will be triggered.

<p>Enable Motion Detection:</p>	<p>Check this box to enable motion detection. Click Save to save the choice.</p>
<p>Enable Motion Tracking:</p>	<p>Check this box to enable motion tracking. Motion tracking is a dynamic display that shows the current status of motion detection. The motion tracking is displayed by a green grid. The grid area represents that the camera detects motion in this area. Click Save to save the choices.</p>

Draw Area:	Click Draw Area button to start drawing. Click and drag on the area you want to set up the motion detection. You can draw up to 8 different areas. Click Stop Drawing to stop drawing motion detection areas. The red grids represent the detection area.
	
Sensitivity:	Move the slider to adjust detection sensitivity.
Clear All:	Click this button to clear all the set up areas.

Arming Schedule

Edit: Click **Edit** to define when you want the motion detection works.

Edit Schedule Time

Period	Start Time	End Time
1	00: 00	24: 00
2	00: 00	00: 00
3	00: 00	00: 00
4	00: 00	00: 00
5	00: 00	00: 00
6	00: 00	00: 00
7	00: 00	00: 00
8	00: 00	00: 00

Copy to Week Select All

Mon
 Tue
 Wed
 Thu
 Fri
 Sat
 Sun

1. Select day of the week you want to edit the schedule.
2. Set the time period you want to enable motion detection. (Default is 0-24 hours, all day).
3. Click **Copy to Week** if you want the same daily schedule everyday. Or, you can select other day of the week and click **Copy** to copy the schedule of the day to other days.
4. Select another day of the week by clicking on its tab to set next schedule. Click **OK** when you finished your setting.

Notification

Send Email:	Check this box to send an e-mail notification when motion is detected.
Network Storage:	Check this box to record video to network storage when motion is detected.
Upload to FTP:	Check this box to send snapshots to an FTP server when motion is detected.

Click **Save** to save the changes.

Tamper-proof

This is to detect if the camera has been tampered with and surveillance is compromised. You can set up tamper proof notifications to alert the system manager to check the camera.

The screenshot displays the 'Tampering Event' configuration page in the TV-IP310PI web interface. The interface is dark-themed with a sidebar on the left containing navigation options: System, Network, Video, Events (highlighted), and Storage. The 'Events' section is expanded to show 'Motion Detection', 'Tamper-proof', 'Exception', 'Snapshot', and 'EMail'. The main content area is titled 'Tampering Event' and includes the following sections:

- Enable Tamper Detection:** A checkbox that is checked.
- AREA SETTINGS:** A video feed showing a large, bright indoor space with a glass ceiling. A timestamp '11-01-2013 Fri 12:10:08-15:30:01' is overlaid on the video. Below the video are buttons for 'Draw Area' and 'Clear All', and a 'Sensitivity' slider.
- ARMING SCHEDULE:** A calendar grid showing the arming schedule for the week. The grid is mostly blue, indicating that tamper detection is armed. A blue 'Edit' button is located above the grid.
- NOTIFICATION:** A section with a 'Send Email' checkbox that is currently unchecked.

A 'Save' button is located at the bottom of the page.

Enable Tamper Detection:	Check this box to enable tamper detection. Click Save to save the settings.
Draw Area:	Click Draw Area button to start drawing. Click and drag on the area you want to set up the tamper detection. You can setup only one area for tamper detection. Click Stop Drawing to stop drawing motion detection areas. The gray block represent the detection area. 
Sensitivity:	Move the slider to adjust detection sensitivity.
Clear All:	Click this button to clear all the set up areas.

Arming Schedule

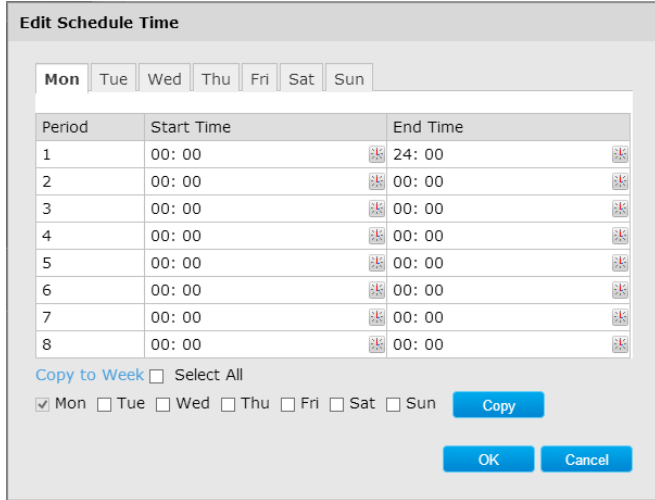
Edit:	Click Edit to define when you want the tamper detection works. 
	<ol style="list-style-type: none"> 1. Select the day of the week you want to edit the schedule. 2. Set the time period you want to enable tamper detection. (Default is 0-24 hours, all day). 3. Click Copy to Week if you want the same daily schedule everyday. Or, you can select other day of the week and click Copy to copy the schedule of the day to other days. 4. Select another day of the week by clicking on its tab to set the next schedule. Click OK when you finished your settings.

Notification

Send Email:	Check this box to send e-mail notification when detects tampering.
--------------------	--------------------------------------------------------------------

Click **Save** to save the changes.

Exception

Provides notifications for other system events, set up your notifications here.

Notification

Exception Type:	<div style="border: 1px solid black; padding: 2px;"> Storage Full Storage Error Illegal Login </div>	First choose the exception type, then choose the corresponding action.
Send Email:	Check this box to send an e-mail notification when an exception is detected.	

Click **Save** to save the changes.

Snapshot

You can set up your camera to continuously taking snapshots or snapshots when an event happens.

The screenshot shows the 'Snapshot' configuration page. On the left is a navigation menu with 'Events' selected. The main area is split into two sections: 'CONTINUOUS' and 'EVENT-TRIGGERED'. Both sections have identical settings for 'Format', 'Resolution', and 'Quality'. The 'Interval' is set to 0 milliseconds. The 'EVENT-TRIGGERED' section has a 'Capture Number' of 4. A 'Save' button is located at the bottom of the settings area.

Continuous

Enable:	Check this box to continuous take snapshots.
Format:	Save snapshots in JPEG format
Resolution:	Uses the same resolution set in Video Format for the snapshot resolution.
Quality:	Choose a compression quality for snapshots.
Interval:	<div style="display: flex; align-items: center;"> <div style="border: 1px solid black; padding: 2px; margin-right: 5px;"> millisecond second minute hour </div> <div>State the time interval between snapshots. The default interval is 10 seconds.</div> </div>

Event triggered

Enable:	Check this box to take snapshots when an event is occurred.
Format:	Save snapshots in JPEG format
Resolution:	Uses the same resolution set in Video Format for the snapshot resolution.
Quality:	Choose a compression quality for snapshot.
Interval:	<div style="display: flex; align-items: center;"> <div style="border: 1px solid black; padding: 2px; margin-right: 5px;"> millisecond second </div> <div>State the time interval between this series of snapshots. The default interval is 1 second.</div> </div>
Capture Number:	State how many snapshots you want to take in a single triggered event. Default: 3 pictures.

Click **Save** to save the changes.

Email

Set up email accounts for notifications.

Sender

Sender:	Enter the name to be appeared as the email sender.
Sender's Address:	Enter sender's email address.
SMTP Server:	Simple Mail Transportation Protocol Server address, the outgoing email server address. It may be has address as your incoming email server, maybe not. Please ask your email service provider for detail.

SMTP Port:	Service port number for outgoing email.*
Enable SSL:	Check this box if your service provider requires a SSL secured connection.
Attach Image/Interval:	Check Attach Image if you want to send a snapshot image with the email notification and select the interval of snapshots in seconds.
Authentication:	Check this box if your server requires a password in order to send email. Most email servers require authentication when sending an email.
User name:	Enter the user name of outgoing email account
Password:	Enter the password
Confirm:	Enter the password again to confirm that the password was entered correctly.

Click **Save** to save the changes.

Receiver

Receiver 1:	The first receiver's name.
Receiver 1's Address:	The first receiver's email address.
Receiver 2:	The second receiver's name.
Receiver 2's Address:	The second receiver's email address.
Receiver 3:	The third receiver's name.
Receiver 3's Address:	The third receiver's email address.

Click **Save** to save the changes.

* Many ISPs does not allow service port 25 going through their network. Other popular ports are 587 and 465. Please consult your email service provider and ISP for detail.

Network Storage

Network Storage

* **Network Storage** must be setup before it can be managed. For storage management, please refer to the next section.

The TV-IP310PI supports two format of network storage file systems: NFS and CIFS. NFS, Network File System, is natively supported by Linux computers and most NAS, Network Attached Storage. CIFS, Common Internet File System, is natively supported by Windows® systems and now is generally supported by Linux and OS X®.

You can add up to 8 network storages for your camera. The recordings will subsequently be stored in these spaces. Save video from the first storage and then the next when the first one is full. Click on the entry to change the settings and click **Save** to save the settings.

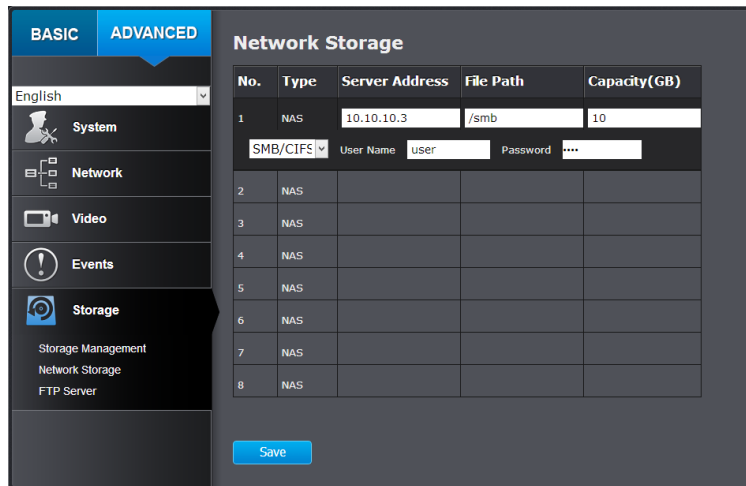

No:	The sequential number of the network storage.
Type:	The type of storage.
Server Address:	Enter the IP address of your network storage.
File Path:	Enter the file path on the server for network storage.
Capacity:	Enter the size of the disk space you want to assign for this storage. The minimum disk space requirement is 10GB. If you do not want to limit the size and use the full physical disk space, put number 0 in this field.
File System:	Choose between NFS or CIFS for file system. If you assign the network storage on a Windows® computer, set it to CIFS.
User Name:	Enter the user name if the network storage requires authentication. Leave it blank if no authentication is required.
Password:	Enter the password to access the network storage.

Click **Save** to save the changes. The camera will reboot to make the network storage available. Go to the next section to format and manage your network storage.

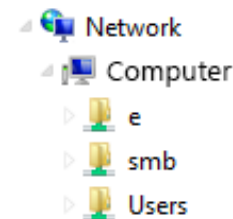

Tip: To create a network storage on your Windows® based system, create a shared folder and then test your set up with another computer. Enter the IP address of the computer here and enter the shared folder name with a leading forward slash. For example, if you have a shared folder named "SMB", enter "/SMB" in the **File Path**.

Storage Management

* **Network Storage** must be setup before it can be managed. For storage setup, please refer to the previous section.

	CAPACITY	FREE SPACE	STATUS	PROPERTY	PROGRESS
■	598.62GB	7.25GB	Normal	R/W	

Format:	Select a network storage and then click Format to format your network storage. This “format” is similar, but not the same as the disk format. Formatting your network storage will allocate and write formatted documents on the assigned network storage for quick searching and logging.
Capacity:	The total capacity this network storage can use.
Free Space:	The free space left for video recording, snapshot and log.
Status:	The connection status to the network storage.
Property:	This network storage is read only or can be read and write.
Progress:	The progress of ongoing task.

FTP Server

Enable Snapshot to FTP:	Check this box if you want to store snapshots on the FTP.
Server Address:	Enter the FTP server IP address.
Port:	Enter the service port number of the FTP server.
User Name/Anonymous:	Check Anonymous if the FTP server does not require authentication. Enter the User Name if the FTP server requires authentication.
Password:	Enter the password of the FTP account.
Confirm:	Enter the password again to make sure the password was entered correctly.

Directory Structure: With Camera Name With Camera IP address:	When saving snapshots on an FTP server, they can be saved in a single place or organized with meaningful directory names. <ul style="list-style-type: none">• Save in root directory: You can choose to store all files in the same folder of FTP login.• Save in directory: Structure your folders with camera name or IP address.
Directory:	<ul style="list-style-type: none">• Use Camera Name: Use the camera name to organize the saved files.• Use Camera IP: Use the camera IP address to organize the saved files.

Click **Save** to save the changes.

Federal Communication Commission Interference Statement

This equipment has been tested and found to comply with the limits for a Class B digital device, pursuant to Part 15 of the FCC Rules. These limits are designed to provide reasonable protection against harmful interference in a residential installation. This equipment generates uses and can radiate radio frequency energy and, if not installed and used in accordance with the instructions, may cause harmful interference to radio communications. However, there is no guarantee that interference will not occur in a particular installation. If this equipment does cause harmful interference to radio or television reception, which can be determined by turning the equipment off and on, the user is encouraged to try to correct the interference by one of the following measures:

- Reorient or relocate the receiving antenna.
- Increase the separation between the equipment and receiver.
- Connect the equipment into an outlet on a circuit different from that to which the receiver is connected.
- Consult the dealer or an experienced radio/TV technician for help.

FCC Caution: Any changes or modifications not expressly approved by the party responsible for compliance could void the user's authority to operate this equipment.

This device complies with Part 15 of the FCC Rules. Operation is subject to the following two conditions: (1) This device may not cause harmful interference, and (2) this device must accept any interference received, including interference that may cause undesired operation.



IMPORTANT NOTE:

FCC Radiation Exposure Statement:

This equipment complies with FCC radiation exposure limits set forth for an uncontrolled environment. This equipment should be installed and operated with minimum distance 20cm between the radiator & your body.

This transmitter must not be co-located or operating in conjunction with any other antenna or transmitter.

The availability of some specific channels and/or operational frequency bands are country dependent and are firmware programmed at the factory to match the intended destination. The firmware setting is not accessible by the end user.

Europe – EU Declaration of Conformity

This device complies with the essential requirements of the Directive 2004/108/EC and 2006/95/EC. The following test methods have been applied in order to prove presumption of conformity with the essential requirements of the Directive 2004/108/EC and 2006/95/EC:

EN 60950-1:2006+A11:2009+A1:2010+A12:2011

IEC 60950-1:2005 (2nd Edition) Am 1:2009

Safety of Information Technology Equipment

EN 55022: 2010 Class A

EN 61000-3-2: 2006 + A1: 2009 + A2: 2009











EN 61000-3-3: 2008









EN 50130-4: 2011

**RoHS**

This product is RoHS compliant.



 Česky [Czech]	TRENDnet tímto prohlašuje, že tento TV-IP310PI je ve shodě se základními požadavky a dalšími příslušnými ustanoveními směrnice 2004/108/ES a 2006/95/ES.
 Dansk [Danish]	Undertegnede TRENDnet erklærer herved, at følgende udstyr TV-IP310PI overholder de væsentlige krav og øvrige relevante krav i direktiv 2004/108/EF og 2006/95/EF.
 Deutsch [German]	Hiermit erklärt TRENDnet, dass sich das Gerät TV-IP310PI in Übereinstimmung mit den grundlegenden Anforderungen und den übrigen einschlägigen Bestimmungen der Richtlinie 2004/108/EG und 2006/95/EG befindet.
 Eesti [Estonian]	Käesolevaga kinnitab TRENDnet seadme TV-IP310PI vastavust direktiivi 2004/108/EÜ ja 2006/95/EÜ põhinõuetele ja nimetatud direktiivist tulenevatele teistele asjakohastele sätetele.
 English [English]	Hereby, TRENDnet, declares that this TV-IP310PI is in compliance with the essential requirements and other relevant provisions of Directive 2004/108/EC and 2006/95/EC.
 Español [Spanish]	Por medio de la presente TRENDnet declara que el TV-IP310PI cumple con los requisitos esenciales y cualesquiera otras disposiciones aplicables o exigibles de la Directiva 2004/108/CE, 2006/95/CE y.
 Ελληνική [Greek]	ΜΕ ΤΗΝ ΠΑΡΟΥΣΑ ΤΡΕΝΔΝΕΤ ΔΗΛΩΝΕΙ ΟΤΙ ΤΟ TV-IP310PI ΣΥΜΜΟΡΦΩΝΕΤΑΙ ΠΡΟΣ ΤΙΣ ΟΥΣΙΩΔΕΙΣ ΑΠΑΙΤΗΣΕΙΣ ΚΑΙ ΤΙΣ ΛΟΙΠΕΣ ΣΧΕΤΙΚΕΣ ΔΙΑΤΑΞΕΙΣ ΤΗΣ ΟΔΗΓΙΑΣ 2004/108/ΕΚ 2006/95/ΕΚ κ.α.
 Français [French]	Par la présente TRENDnet déclare que l'appareil TV-IP310PI est conforme aux exigences essentielles et aux autres dispositions pertinentes de la directive 2004/108/CE 2006/95/CE et.
 Italiano [Italian]	Con la presente TRENDnet dichiara che questo TV-IP310PI è conforme ai requisiti essenziali ed alle altre disposizioni pertinenti stabilite dalla direttiva 2004/108/CE e 2006/95/CE.
 Latvīski [Latvian]	Ar šo TRENDnet deklarē, ka TV-IP310PI atbilst Direktīvas 2004/108/EK un 2006/95/EK būtiskajām prasībām un citiem ar to saistītajiem noteikumiem.
 Lietuvių [Lithuanian]	Šiuo TRENDnet deklaruoja, kad šis TV-IP310PI atitinka esminius reikalavimus ir kitas 2004/108/EB ir 2006/95/EB Direktyvos nuostatas.

 Nederlands [Dutch]	Hierbij verklaart TRENDnet dat het toestel TV-IP310PI in overeenstemming is met de essentiële eisen en de andere relevante bepalingen van richtlijn 2004/108/EG en 2006/95/EG.
 Malti [Maltese]	Hawnhekk, TRENDnet, jiddikjara li dan TV-IP310PI jikkonforma mal-htigijiet essenzjali u ma provvedimenti oħrajn relevanti li hemm fid-Dirrettiva 2004/108/KE u 2006/95/KE.
 Magyar [Hungarian]	Alulírott, TRENDnet nyilatkozom, hogy a TV-IP310PI megfelel a vonatkozó alapvető követelményeknek és az 2004/108/EK irányelv a 2006/95/EK irányelv egyéb előírásainak.
 Polski [Polish]	Niniejszym TRENDnet oświadcza, że TV-IP310PI jest zgodny z zasadniczymi wymogami oraz pozostałymi stosownymi postanowieniami Dyrektywy 2004/108/WE i 2006/95/WE.
 Português [Portuguese]	TRENDnet declara que este TV-IP310PI está conforme com os requisitos essenciais e outras disposições da Directiva 2004/108/CE e 2006/95/CE.
 Slovensko [Slovenian]	TRENDnet izjavlja, da je ta TV-IP310PI v skladu z bistvenimi zahtevami in ostalimi relevantnimi določili direktive 2004/108/ES a 2006/95/ES.
 Slovensky [Slovak]	TRENDnet týmto vyhlasuje, že TV-IP310PI spĺňa základné požiadavky a všetky príslušné ustanovenia Smernice 2004/108/EF a 2006/95/EF.
 Suomi [Finnish]	TRENDnet vakuuttaa täten että TV-IP310PI tyyppinen laite on direktiivin 2004/108/EY ja 2006/95/EY oleellisten vaatimusten ja sitä koskevien direktiivin muiden ehtojen mukainen.
 Svenska [Swedish]	Härmed intygar TRENDnet att denna TV-IP310PI står i överensstämmelse med de väsentliga egenskapskrav och övriga relevanta bestämmelser som framgår av direktiv 2004/108/EG och 2006/95/EG.

Limited Warranty

TRENDnet warrants its products against defects in material and workmanship, under normal use and service, for the following lengths of time from the date of purchase.

- TV-IP310PI – 3 Years Warranty

If a product does not operate as warranted during the applicable warranty period, TRENDnet shall reserve the right, at its expense, to repair or replace the defective product or part and deliver an equivalent product or part to the customer. The repair/replacement unit's warranty continues from the original date of purchase. All products that are replaced become the property of TRENDnet. Replacement products may be new or reconditioned. TRENDnet does not issue refunds or credit. Please contact the point-of-purchase for their return policies.

TRENDnet shall not be responsible for any software, firmware, information, or memory data of customer contained in, stored on, or integrated with any products returned to TRENDnet pursuant to any warranty.

There are no user serviceable parts inside the product. Do not remove or attempt to service the product by any unauthorized service center. This warranty is voided if (i) the product has been modified or repaired by any unauthorized service center, (ii) the product was subject to accident, abuse, or improper use (iii) the product was subject to conditions more severe than those specified in the manual.

Warranty service may be obtained by contacting TRENDnet within the applicable warranty period and providing a copy of the dated proof of the purchase. Upon proper submission of required documentation a Return Material Authorization (RMA) number will be issued. An RMA number is required in order to initiate warranty service support for all TRENDnet products. Products that are sent to TRENDnet for RMA service must have the RMA number marked on the outside of return packages and sent to TRENDnet prepaid, insured and packaged appropriately for safe shipment. Customers shipping from outside of the USA and Canada are responsible for return shipping fees. Customers shipping from outside of the USA are responsible for custom charges, including but not limited to, duty, tax, and other fees.

WARRANTIES EXCLUSIVE: IF THE TRENDNET PRODUCT DOES NOT OPERATE AS WARRANTED ABOVE, THE CUSTOMER'S SOLE REMEDY SHALL BE, AT TRENDNET'S OPTION, REPAIR OR REPLACE. THE FOREGOING WARRANTIES AND REMEDIES ARE EXCLUSIVE AND ARE IN LIEU OF ALL OTHER WARRANTIES, EXPRESSED OR IMPLIED, EITHER IN FACT OR BY OPERATION OF LAW, STATUTORY OR OTHERWISE, INCLUDING WARRANTIES OF MERCHANTABILITY AND FITNESS FOR A PARTICULAR PURPOSE.

TRENDNET NEITHER ASSUMES NOR AUTHORIZES ANY OTHER PERSON TO ASSUME FOR IT ANY OTHER LIABILITY IN CONNECTION WITH THE SALE, INSTALLATION MAINTENANCE OR USE OF TRENDNET'S PRODUCTS.

TRENDNET SHALL NOT BE LIABLE UNDER THIS WARRANTY IF ITS TESTING AND EXAMINATION DISCLOSE THAT THE ALLEGED DEFECT IN THE PRODUCT DOES NOT EXIST OR WAS CAUSED BY CUSTOMER'S OR ANY THIRD PERSON'S MISUSE, NEGLIGENCE, IMPROPER INSTALLATION OR TESTING, UNAUTHORIZED ATTEMPTS TO REPAIR OR MODIFY, OR ANY OTHER CAUSE BEYOND THE RANGE OF THE INTENDED USE, OR BY ACCIDENT, FIRE, LIGHTNING, OR OTHER HAZARD.

LIMITATION OF LIABILITY: TO THE FULL EXTENT ALLOWED BY LAW TRENDNET ALSO EXCLUDES FOR ITSELF AND ITS SUPPLIERS ANY LIABILITY, WHETHER BASED IN CONTRACT OR TORT (INCLUDING NEGLIGENCE), FOR INCIDENTAL, CONSEQUENTIAL, INDIRECT, SPECIAL, OR PUNITIVE DAMAGES OF ANY KIND, OR FOR LOSS OF REVENUE OR PROFITS, LOSS OF BUSINESS, LOSS OF INFORMATION OR DATE, OR OTHER FINANCIAL LOSS ARISING OUT OF OR IN CONNECTION WITH THE SALE, INSTALLATION, MAINTENANCE, USE, PERFORMANCE, FAILURE, OR INTERRUPTION OF THE POSSIBILITY OF SUCH DAMAGES, AND LIMITS ITS LIABILITY TO REPAIR, REPLACEMENT, OR REFUND OF THE PURCHASE PRICE PAID, AT TRENDNET'S OPTION. THIS DISCLAIMER OF LIABILITY FOR DAMAGES WILL NOT BE AFFECTED IF ANY REMEDY PROVIDED HEREIN SHALL FAIL OF ITS ESSENTIAL PURPOSE.

Governing Law: This Limited Warranty shall be governed by the laws of the state of California.

Some TRENDnet products include software code written by third party developers. These codes are subject to the GNU General Public License ("GPL") or GNU Lesser General Public License ("LGPL").

Go to <http://www.trendnet.com/gpl> or <http://www.trendnet.com> Download section and look for the desired TRENDnet product to access to the GPL Code or LGPL Code. These codes are distributed WITHOUT WARRANTY and are subject to the copyrights of the developers. TRENDnet does not provide technical support for these codes. Please go to <http://www.gnu.org/licenses/gpl.txt> or <http://www.gnu.org/licenses/lgpl.txt> for specific terms of each license.



Product Warranty Registration

Please take a moment to register your product online.
Go to TRENDnet's website at <http://www.trendnet.com/register>

TRENDnet
20675 Manhattan Place
Torrance, CA 90501. USA