

TRENDNET®



Quick Installation Guide

TV-IP1318PI / TV-IP1319PI (V1)

Table of Contents

1 English

1. Before You Start
2. Hardware Installation and Configuration

1. Before You Start

Package Contents

- TV-IP1318PI / TV-IP1319PI
- Torx Security Allen Key (TV-IP1319PI only)
- Quick Installation Guide
- Weather Seal

Minimum Requirements

- An Android or iOS device
- Working internet service and Wi-Fi
- Existing PoE network
- Network cable

Free Mobile App: TRENDnet Mira Requirements

Supported Operating Systems

Android (version 4.4 or above)

iOS (version 8.2 or above)

Note: Scan the QR code with your mobile device to install the App.



iOS Mira



Android Mira

Using a PoE switch

Note:

- Connect the TV-IP1318PI / TV-IP1319PI to your network using an existing 802.3af/at compliant PoE switch or injector.
- For outdoor installation, please configure weather seal (included) per the diagram below, you will have to terminate the RJ-45 connector after the weather seal has been applied.

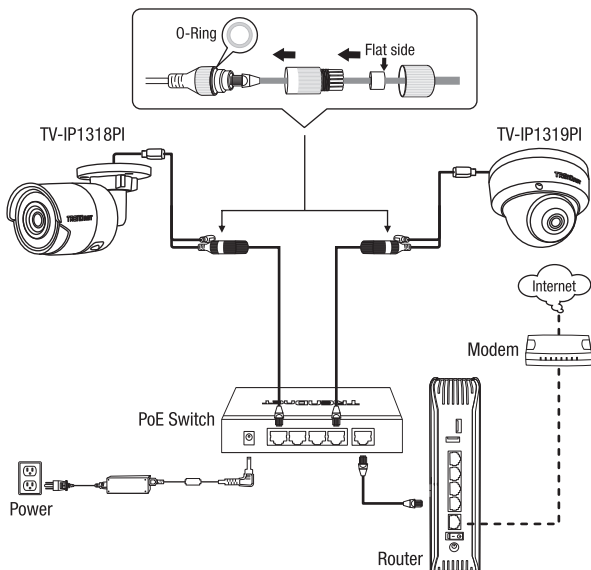

2. Hardware Installation and Configuration

1. Do not install or mount the IP camera until after you complete the installation steps below. Temporarily place the IP camera near you and connected to a network.
2. Download and Install the TRENDnet Mira app on your mobile device, then open the app.

Note: Please connect your mobile device to the Wi-Fi of the same network of which the camera will be connected to.



3. Once you open the app, it will ask you to **Select Country or Region**. Please select your country or region and proceed to the login page.



4. Once you open the app, click the **Login** button.

Note: if you do not have an account please takes the steps necessary to create one.



5. Once you login, click the **Add Device** button.

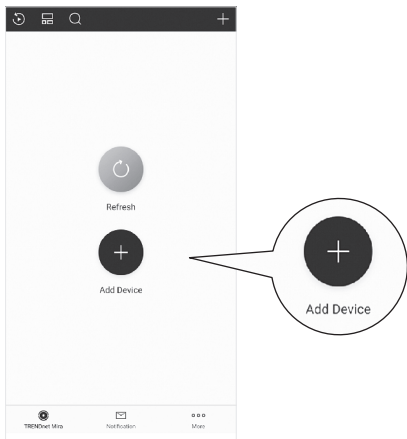

6. After clicking **Add Device**, you will then have to scan the QR Code on the label of the camera with your mobile device.

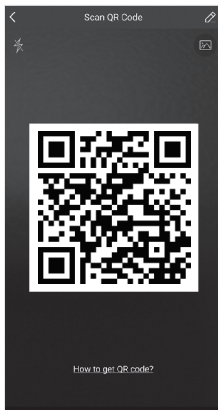
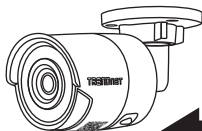

7. Once you scan the QR code you will be asked to press **Next**.



8. Please enter the verification code. Default code is **TNMira**.

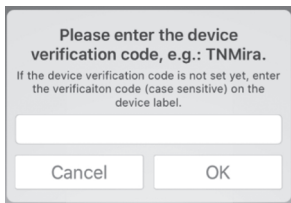

Please enter the device verification code, e.g.: TNMira.

If the device verification code is not set yet, enter the verification code (case sensitive) on the device label.

Cancel OK

9. To activate a new device, you will need to create a password and press **Activate**.

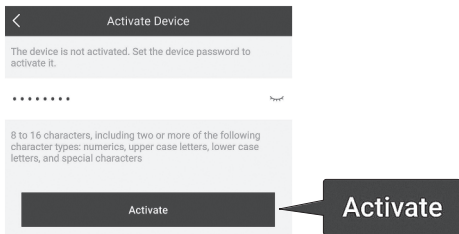

Activate Device

The device is not activated. Set the device password to activate it.

.....

8 to 16 characters, including two or more of the following character types: numerics, upper case letters, lower case letters, and special characters

Activate

Activate

10. Adding has been completed, Press **Next**.

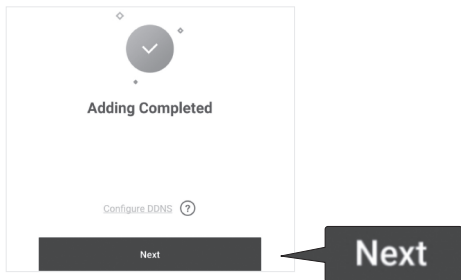

11. Edit Alias of your camera and press **Save**. After this step you will be taken to the live view of your camera.

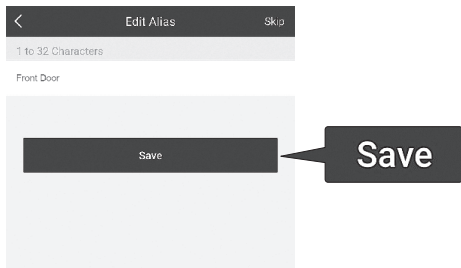

12. Once added you should see a live image from the camera and you are finished.

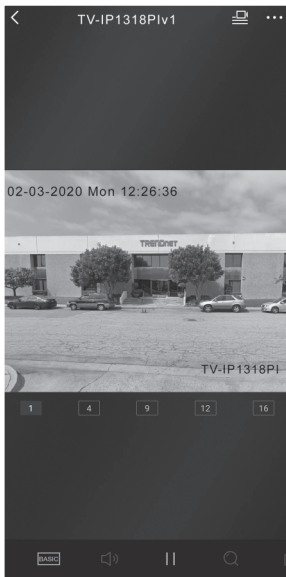

Mounting the camera

1. Place the provided template label on the wall or ceiling.

For TV-IP1318PI

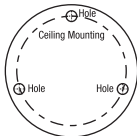

For TV-IP1319PI

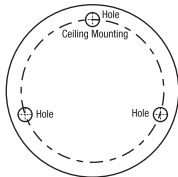

2. Drill holes at each marked position on the template. Make sure the drill bit matches the size of the holes on the template.
3. (Dome) Remove the dome cover using the provided Torx security allen key.

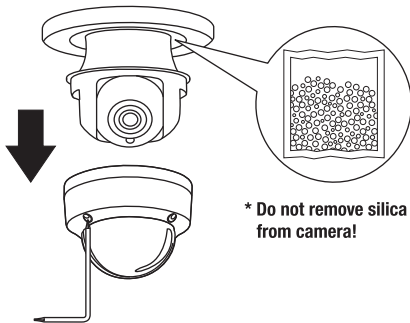

*** Do not remove silica packet from camera!**

4. Insert the screw anchors into the holes, and align the mounting base over them. Then use the provided screws to secure the camera to the mounting surface.

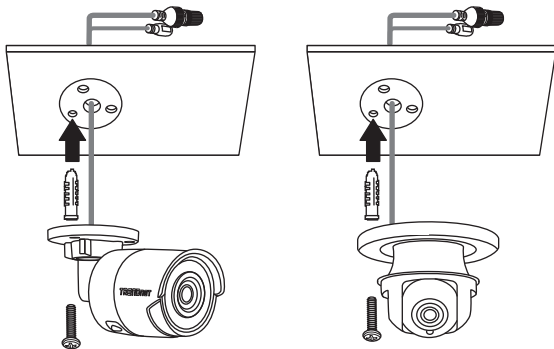

- 4A. (Bullet) Manually adjust your camera to the desired viewing position.

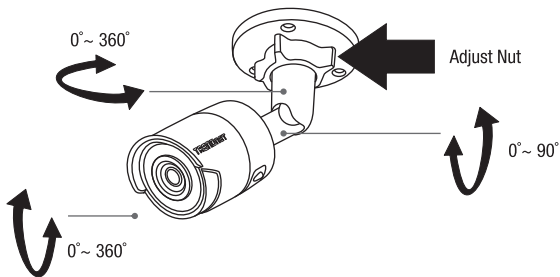

- 4B. (Dome) Manually adjust your camera to the desired viewing position. When finished, attach the dome cover back on the dome using the Torx security allen key.

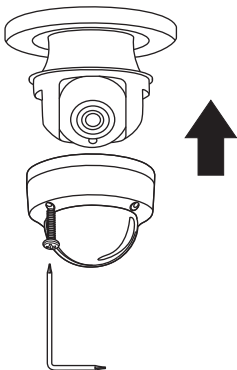
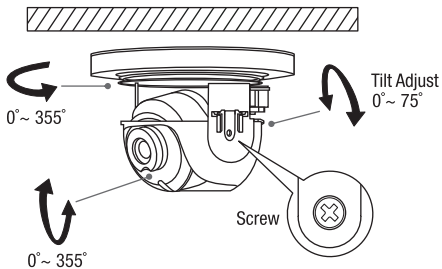

Declaration of Conformity

TRENDNET®

Manufacturer's Name and Address

TRENDnet, Inc.
20675 Manhattan Place
Torrance, CA 90501 USA



Zwolsestraat 156 2587 WB
The Hague The Netherlands

Product Information

Model Number: TV-IP1318PI / TV-IP1319PI

Product Name: Indoor/Outdoor 8MP 4K H.265 WDR PoE IR Bullet Network Camera
Indoor/Outdoor 8MP 4K H.265 WDR PoE IR Dome Network Camera

Trade Name: TRENDnet

TRENDnet hereby declare that the product is in compliance with the essential requirements and other relevant provisions under our sole responsibility.

EMC EN 55032: 2015
EN 61000-3-2: 2014
EN 61000-3-3: 2013
EN 50130-4: 2011 + A1: 2014

This product is herewith confirmed to comply with the Directives.

Directives: Directive LVD 2014/35/EU
Directive EMC 2014/30/EU
Directive RoHS 2011/65/EU
REACH Règlement (EU) N° 1907/2006

Person responsible for this declaration.

Place of Issue: Torrance, California, USA

Date: March 31, 2020

Name: Sonny Su

Title: Director of Technology

Signature:

A handwritten signature in black ink, appearing to read 'Sonny Su', is written over a horizontal line.



Certifications

This device complies with Part 15 of the FCC Rules. Operation is subject to the following two conditions: (1) this device may not cause harmful interference, and (2) this device must accept any interference received. Including interference that may cause undesired operation.



Waste electrical and electronic products must not be disposed of with household waste. Please recycle where facilities exist. Check with your Local Authority or Retailer for recycling advice.

Technical Support

If you have any questions regarding the product installation, please contact our Technical Support. Toll free US/Canada: **1-866-845-3673**
Regional phone numbers available at www.trendnet.com/support

TRENDnet

20675 Manhattan Place
Torrance, CA 90501
USA

Applies to PoE Products Only: This product is to be connected only to PoE networks without routing to the outside plant.

Note

The Manufacturer is not responsible for any radio or TV interference caused by unauthorized modifications to this equipment. Such modifications could void the user's authority to operate the equipment.

Advertencia

En todos nuestros equipos se mencionan claramente las características del adaptador de alimentación necesario para su funcionamiento. El uso de un adaptador distinto al mencionado puede producir daños físicos y/o daños al equipo conectado. El adaptador de alimentación debe operar con voltaje y frecuencia de la energía eléctrica domiciliar existente en el país o zona de instalación.

Product Warranty Registration

Please take a moment to register your product online. Go to TRENDnet's website at: **www.trendnet.com/register**