

# TRENDnet®



---

## Quick Installation Guide

### PoE Web Smart Switch Series

# Table of Contents

---

## **1 Русский**

1. Перед началом работы
2. Краткий справочник
3. Установка и настройка оборудования

# 1. Перед началом работы

## Содержимое упаковки

- Руководство по быстрой установке
- Сетевой провод (1.8 м / 6 футов)
- Набор оборудования монтажной стойки

## Требования к установке

- Компьютер с портом Ethernet и веб-браузер
- Сетевой кабель

## Дополнительное оборудование

- Корпус 19 дюймов стандарта EIA
- Модуль SFP (напр., TE100-MGBFX, TEG-MGBSX, TEG-MGBS10, TEG-MGBS40, TEG-MGBS80, TEG-MGBS10D3, TEG-MGBS10D5, TEG-MGBS40D3, TEG-MGBS40D5)

# 2. Краткий справочник

PoE Camera

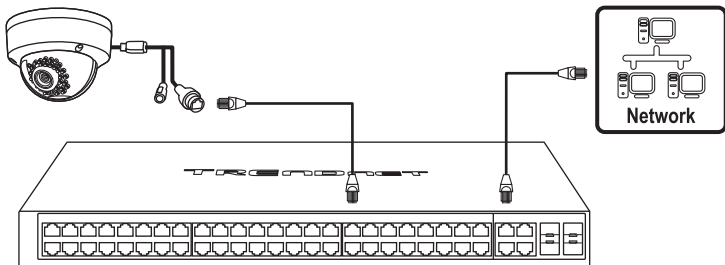

PoE Camera

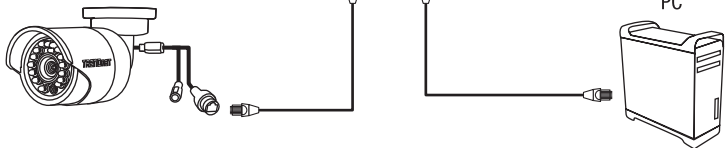

**Примечание:** Модель переключателя может отличаться от той, которая показана в приведенном ниже примере.

### 3. Установка и настройка оборудования

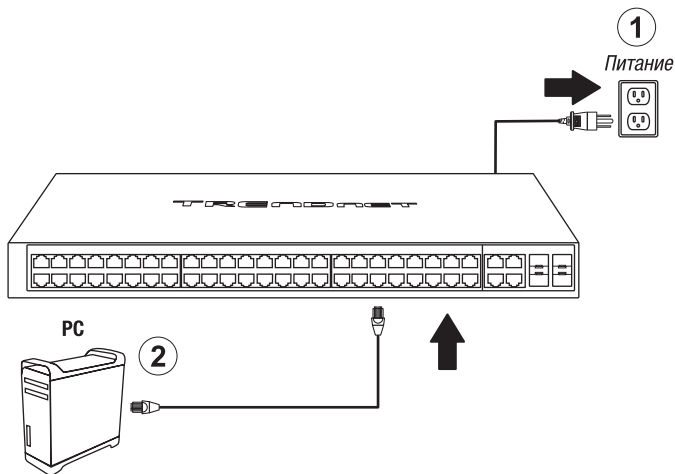

3. Необходимо назначить сетевому адаптеру компьютера статический IP-адрес в подсети 192.168.10.x (напр., 192.168.10.25) и маску подсети 255.255.255.0.
4. Откройте свой браузер, введите IP-адрес коммутатор в адресной строке и нажмите на **Enter** (Ввод). IP-адрес по умолчанию 192.168.10.200.

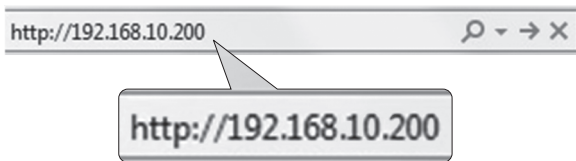

5. Введите **User Name** (имя пользователя) и **Password** (пароль), затем щелкните по кнопке **LOGIN**. По умолчанию:

User name (Имя пользователя): **admin**

Password (Пароль): **admin**

**Примечание:** Имя пользователя и пароль следует вводить с учетом регистра.

The screenshot shows a login interface with two input fields. The first field is labeled 'User Name:' and contains the text 'admin'. The second field is labeled 'Password:' and contains six dots. Below the fields is a 'LOGIN' button. Callout boxes point to the 'admin' text in both fields and the 'LOGIN' button.

6. Нажмите **System** (Система), а затем **IPv4 Setup** (Настройка IPv4).
7. Настройте коммутатор в соответствии с требованиями сети. Нажмите кнопку **Apply** (Применить) чтобы сохранить изменения.

The screenshot shows a configuration menu on the left and a configuration page on the right. The left menu has 'System' and 'IPv4 Setup' highlighted with callout boxes. The right page is titled 'IPv4 Setup' and contains the following fields:

System MAC Address:	00:01:02:03:04:05
System IP Address:	192 · 168 · 10 · 200
System Subnet Mask:	255 · 255 · 255 · 0
System Default Gateway:	0 · 0 · 0 · 0
System IP Mode:	Static

Below the fields is an 'Apply' button, which is pointed to by a callout box.

8. Щелкните на **OK**.

The screenshot shows a warning dialog box with a title bar that says 'WARNING'. On the left is a warning icon (a triangle with an exclamation mark). To the right of the icon is the text: 'The management session will be disconnected. Use new IP address to connect to device.' At the bottom of the dialog are three buttons: 'OK', 'OK', and 'Cancel'. A callout box points to the first 'OK' button.

9. В левой панели выберите «Сервис» **Tools**, нажмите на «Конфигурация» **Configuration** и нажмите на «Сохранить» **Save**.

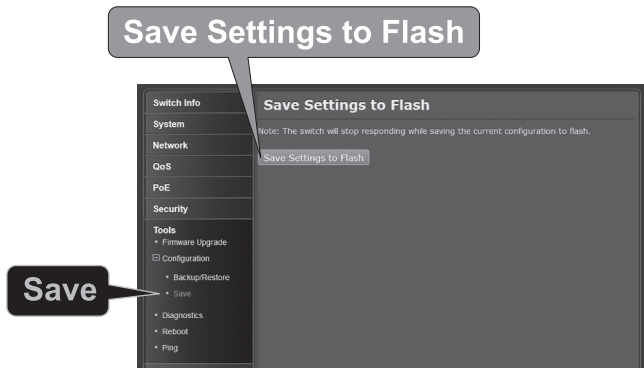

10. Щелкните на "OK".

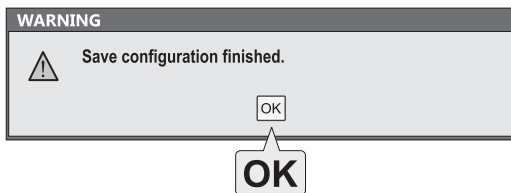

**Примечание:**

1. При необходимости простого нахождения в сети всех управляющих коммутаторов, работающих на основе веб-технологии, назначения IP-адреса, изменения пароля и обновления встроенных программ достаточно воспользоваться служебной программой Web Management Utility. Выполните нижеприведенные указания.
2. Загрузить самую последнюю версию направляющего выступа и общего назначения потребителя, пожалуйста пойдите к <http://www.trendnet.com/support> и выбирает **Switch Model** в пределах Загрузки Продуктов раскрывающийся список.

## UL Warning

- 1) Elevated Operating Ambient Temperature - If installed in a closed or multi-unit rack assembly, the operating ambient temperature of the rack environment may be greater than room ambient. Therefore, consideration should be given to installing the equipment in an environment compatible with the manufacturer's maximum rated ambient temperature (T<sub>ma</sub>).
- 2) Reduced Air Flow - Installation of the equipment in a rack should be such that the amount of air flow required for safe operation of the equipment is not compromised.
- 3) Mechanical Loading - Mounting of the equipment in the rack should be such that a hazardous condition is not achieved due to uneven mechanical loading.
- 4) Circuit Overloading - Consideration should be given to the connection of the equipment to the supply circuit and the effect that overloading of circuits might have on over current protection and supply wiring. Appropriate consideration of equipment nameplate ratings should be used when addressing this concern.
- 5) Reliable Earthing - Reliable earthing of rack-mounted equipment should be maintained. Particular attention should be given to supply connections other than direct connections to the branch circuit (e.g., use of power strips).

## Rack Installation

The Switch can be mounted in an EIA standard, 19-inch rack, which can be placed in a wiring closet with other equipment. To install, attach the mounting brackets to the switch's front panel (one on each side) and secure them with the screws provided.

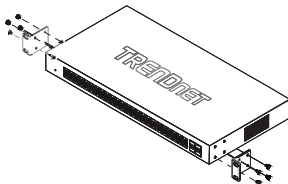

### Attaching the mounting brackets to the Switch

Use the screws provided with the equipment rack to mount the Switch on the rack.

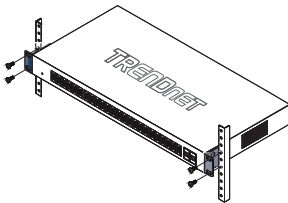

### Installing the Switch in an equipment rack

## Certifications

This device complies with Part 15 of the FCC Rules.

Operation is subject to the following two conditions:

- (1) This device may not cause harmful interference.
- (2) This device must accept any interference received.

Including interference that may cause undesired operation.



Waste electrical and electronic products must not be disposed of with household waste. Please recycle where facilities exist. Check with your Local Authority or Retailer for recycling advice.

## FCC warning:

This equipment has been tested and found to comply with the limits for a Class A digital device, pursuant to part 15 of the FCC Rules. These limits are designed to provide reasonable protection against harmful interference when the equipment is operated in a commercial environment. This equipment generates, uses, and can radiate radio frequency energy and, if not installed and used in accordance with the instruction manual, may cause harmful interference to radio communications. Operation of this equipment in a residential area is likely to cause harmful interference in which case the user will be required to correct the interference at his own expense.

## FCC Caution:

Any changes or modification not expressly approved by the party responsible for compliance could void the user's authority to operate this equipment.

## Technical Support

If you have any questions regarding the product installation, please contact our Technical Support.

Toll free US/Canada: **1-855-373-4741**

Regional phone numbers available at [www.trendnet.com/support](http://www.trendnet.com/support)

## TRENDnet

20675 Manhattan Place  
Torrance, CA 90501  
USA

Applies to PoE Products Only: This product is to be connected only to PoE networks without routing to the outside plant.

## Note

The Manufacturer is not responsible for any radio or TV interference caused by unauthorized modifications to this equipment. Such modifications could void the user's authority to operate the equipment.

## Avertissement

S'applique uniquement aux produits PoE: Ce produit doit être raccordé qu'aux réseaux PoE sans routage vers l'installation extérieure.

## Advertencia

En todos nuestros equipos se mencionan claramente las características del adaptador de alimentación necesario para su funcionamiento. El uso de un adaptador distinto al mencionado puede producir daños físicos y/o daños al equipo conectado. El adaptador de alimentación debe operar con voltaje y frecuencia de la energía eléctrica domiciliaria existente en el país o zona de instalación.

## UL warning:

The equipment power supply cord shall be connected to a socket-outlet with earthing connection.

Le cordon d'alimentation de l'appareil doit être raccordé à une prise de courant avec mise à la terre.

## Fiber product warning note:

If the Optical Transceiver doesn't ship with the unit, the user manual shall have the description as below or equivalent:

"This product is intended to be used with a UL Listed Optical Transceiver product, Rated DC3.3V, Laser Class I."

## Laser warning note:

This product is intended to be used with a UL Listed Optical Transceiver product, Rated DC3.3V, Laser Class I.

## Product Warranty Registration

Please take a moment to register your product online. Go to TRENDnet's website at:

[www.trendnet.com/register](http://www.trendnet.com/register)