



## Industrial SFP to Gigabit UPoE Media Converter

TI-UF11SFP (v2.0R)

- Hardened IP30 rated SFP to Gigabit UPoE converter
- SFP port accommodates Multi or Single Mode fiber
- Up to 40 km fiber networking distances with the TI-MGBS40 SFP module
- Provides up to 60W for PoE, PoE+ and UPoE compliant devices
- Includes DIN-rail and wall mounts
- Wide operating temperature range -40 to 75 °C (-40 to 167 °F)
- Overload current protection
- Powers supply sold separately (model TI-S12048)
- Lifetime Warranty

TRENDnet's Industrial SFP to Gigabit UPoE Media Converter, model TI-UF11SFP, converts fiber to copper while providing power to PoE, PoE+, and UPoE compliant devices, such as IP cameras, VoIP phones, and wireless access points. With an operating temperature range of -40°– 75 °C (-40° – 167 °F), the hardened IP30 rated housing is suitable for industrial environments. Dual redundant power inputs (power supply sold separately: TI-S12048) with overload current protection minimizes downtime.

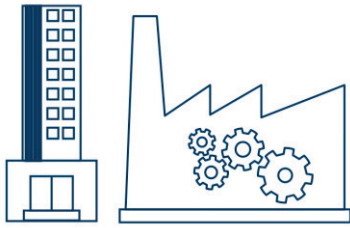

### Industrial Applications

Networks devices for manufacturing, general industrial, logistics, surveillance, and corporate applications.

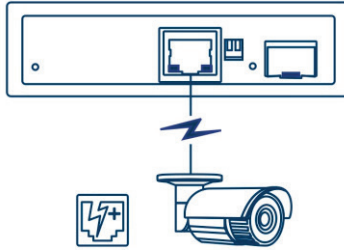

### PoE+ Output

Converts fiber to copper while providing power to PoE and PoE+ compliant devices such as IP cameras, VoIP phones, and wireless access points.



### Extreme Environments

Hardened IP30 converter for extreme networking environments, with a -40 to 75 °C (-40 to 167 °F) operating temperature range

## NETWORKING SOLUTION

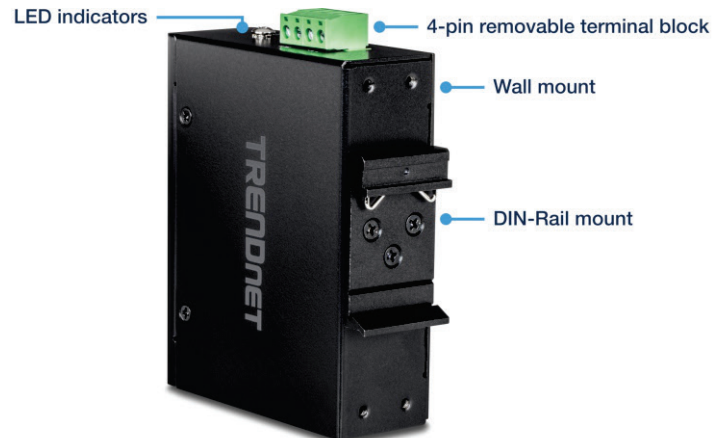
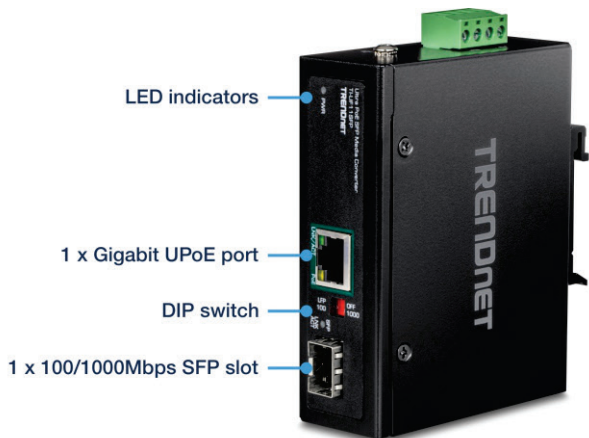
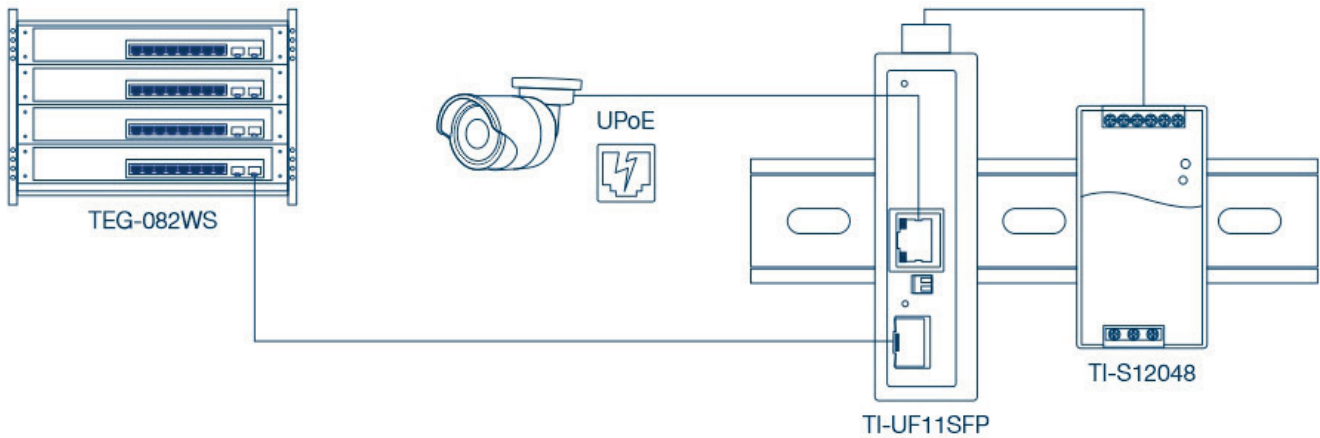

## FEATURES

- 

**Network Ports**

1 x Gigabit PoE+ Ethernet port and 1 x SFP slot
- 

**DIN-Rail/Wall Mounts**

IP30 rated metal enclosure with included DIN-rail and wall mount hardware
- 

**Switching Capacity**

2Gbps switching capacity
- 

**Jumbo Frame**

Sends larger packets, or Jumbo Frames (up to 9KB), for increased performance
- 

**Extreme Temperatures**

Hardened converter is rated for a wide operating temperature range of -40 to 75 °C (-40 to 167 °F)
- 

**Electromagnetic Compliance**

Complies with FCC Part 15 Subpart B Class A and CE EN 55022 Class A standards
- 

**Certifications**

Rated for information technology (ITE) equipment (EN55022/24) and industrial, scientific, and medical (ISM) Equipment (EN55011)
- 

**Shock and Vibration Resistant**

Rated for shock (IEC 60068-2-27), freefall (IEC 60068-2-32), and vibration (IEC 60068-2-6)
- 

**Grounding Point**

Grounding point protects equipment from external electrical surges

## DIMENSIONS (mm)

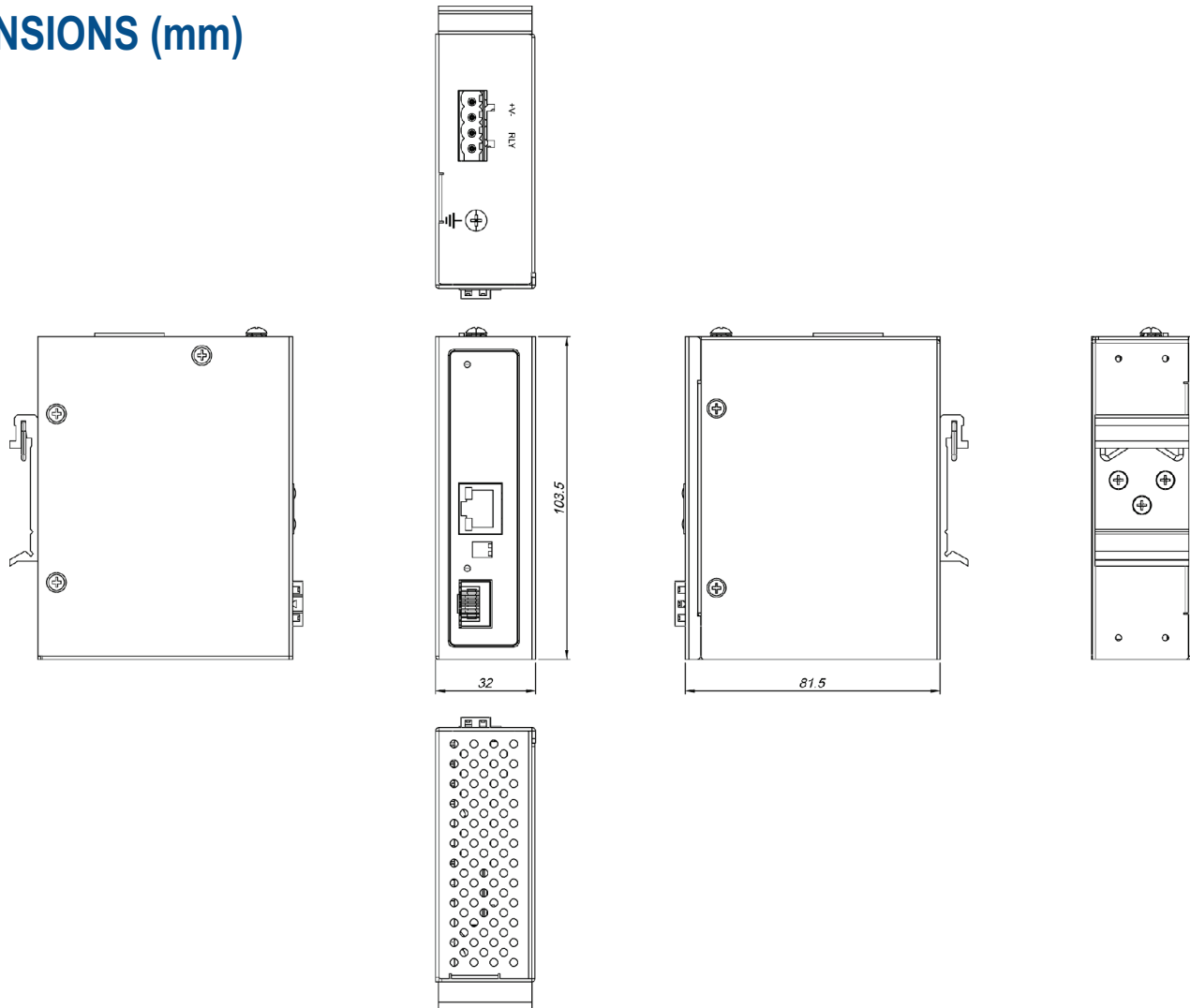

## SPECIFICATIONS

### Standards

- IEEE 802.3
- IEEE 802.3u
- IEEE 802.3ab
- IEEE 802.3z
- IEEE 802.3x
- IEEE 802.3af
- IEEE 802.3at
- IEEE 802.3bt draft

### Device Interface

- 1 x Gigabit UPoE port
- 1 x 100/1000Mbps SFP slot
- 4-pin removable terminal block
- LED indicators
- DIP switch
- DIN-Rail mount
- Wall mount
- Grounding point

### Data Transfer Rate

- Ethernet: 10Mbps (half duplex), 20Mbps (full duplex)
- Fast Ethernet: 100Mbps (half duplex), 200Mbps (full duplex)
- Gigabit: 2000Mbps (full duplex)

### Performance

- Data RAM Buffer: 1MB
- Jumbo Frame: 9KB
- MAC Address Table: 2K

### Special Features

- Hardened components rated for extreme temperatures
- Auto-Negotiation
- Automatic address learning and address aging

### Power

- Input: 48 – 56V DC
- Required power supply: TI-S12048 (sold separately)
- Max. consumption: 72W

### PoE

- Pin 3, 6, 4, 5 for power (+) and pin 1, 2, 7, 8 for power (-)
- Power budget: 60W

### Terminal Block

- Power and relay inputs, 4 pin
- Wire range: 0.34mm<sup>2</sup> to 2.5mm<sup>2</sup>
- Solid wire (AWG): 12-24/14-22
- Stranded wire (AWG): 12-24/14-22
- Torque: 5lbs. – In / 0.5Nm / 0.56 Nm
- Wire strip length: 7-8mm

### DIP Switch

- 1: reserved, no function
- 2: set SFP speed to 100Mbps or 1000Mbps

### MTBF

- 510,304 hours

### Housing

- IP30 aluminum housing
- DIN-Rail mount
- Wall mount
- Grounding point

### Operating Temperature

- -40 – 75°C (-40 – 167°F)

### Operating Humidity

- Max. 95% non-condensing

### Dimensions

- 103.5 x 81.5 x 32mm (4 x 3.2 x 1.2 in.)

### Weight

- 153g (5.39 oz.)

### Certifications

- CE
- FCC
- Shock (IEC 60068-2-27)
- Freefall (IEC 60068-2-32)
- Vibration (IEC 60068-2-6)
- EN60950-1 (LVD)

### Warranty

- 3 years

### Package Contents

- TI-UF11SFP
- Quick Installation Guide
- Removable terminal block
- DIN-Rail and wall mount kit

All references to speed are for comparison purposes only. Product specifications, size, and shape are subject to change without notice, and actual product appearance may differ from that depicted herein.

TRENDnet offers a lifetime warranty for all of its metal-enclosed network switches that have been purchased in the United States/Canada on or after 1/1/2015. Cooling fan and internal power supply carry a one-year warranty.