

TRENDNET®



Quick Installation Guide

TFC-1600(V1)

Table of Contents

1 Español

1. Antes de comenzar
2. Instalación Del Hardware

1. Antes de iniciar

Contenidos del paquete





- Convertidor de fibra
- Guía de instalación rápida
- Cable de corriente
- Soportes para montaje en bastidor

Requisitos mínimos

- Un ambiente que sea bastante fresco y seco
- Un ambiente donde no haya generadores de campos electromagnéticos fuertes (como motores), vibraciones, polvo o exposición directa a la luz solar
- Conmutador Ethernet a 10/100Mbps
- Cables de fibra para conexiones de modo sencillo (Single-mode)
- Cable CAT-5 RJ-45 para ethernet
- Un chasis TFC-1600 (opcional) o una superficie firme y nivelada capaz de sostener el peso del Convertidor de fibra
- TFC-1600MM (opcional)

Nota: La funcionalidad de gestión requiere el chasis TFC-1600 y el módulo de gestión TFC-1600MM.

Modelos compatibles

Nombre del modelo	Multimodo / Monomodo	Fiber Connector
TFC-110S60i / TFC-110S60 / TFC-110S30i / TFC-110S30 / TFC-110S15i / TFC-110S15 / TFC-110S100 / TFC-1000S70 / TFC-1000S50 / TFC-1000S20	Monomodo (Duplex)	SC (Duplex) 
TFC-110S40D5i / TFC-110S40D3i / TFC-110S40D3 / TFC-110S20D5i / TFC-110S20D5 / TFC-110S20D3i / TFC-110S20D3 / TFC-1000S60D5 / TFC-1000S60D3 / TFC-1000S40D5 / TFC-1000S40D3 / TFC-1000S10D5 / TFC-1000S10D3	Monomodo (Simple)	SC (Simple) 
TFC-110MST (ST) / TFC-110MM (MT-RJ)	Multimodo	ST (Duplex) 
TFC-110MSC / TFC-1000MSC	Multimodo	MT-RJ (Simple) 
TFC-1000MGA	Multimodo / Monomodo	Depende en SFP

2. Hardware Installation

Instalación de 2 convertidores de fibra de forma independiente

1. Conecte el cable de fibra a los convertidores. Este cable debe ser de modo sencillo.
2. Conecte un cable de ethernet RJ-45 desde el puerto ethernet de los convertidores de fibra hasta un puerto ethernet del conmutador (ex: TEG-160WS)
3. Conecte el adaptador de corriente a la parte posterior del convertidor.

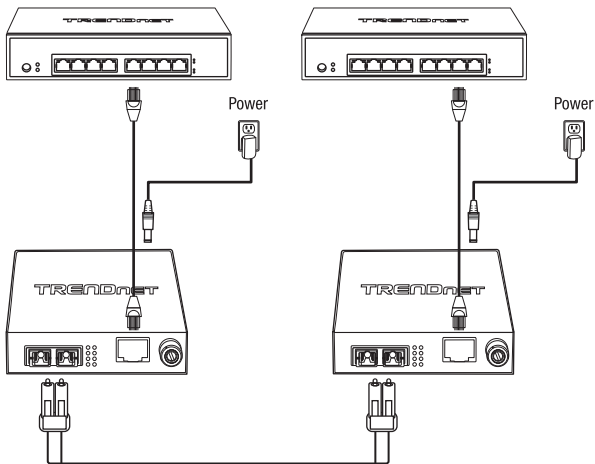

Nota: Los cables TX y RX deben colocarse a la inversa en la conexión de fibra del lado opuesto.

Instalación del las fuentes de alimentación

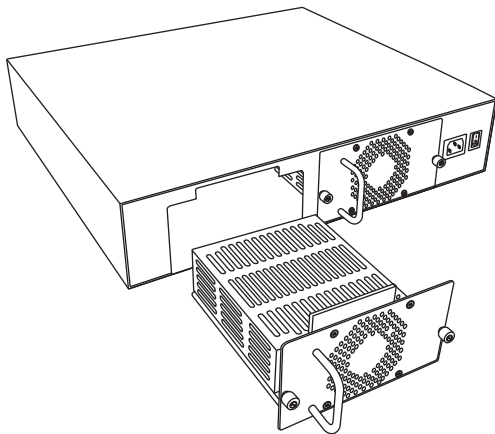

Nota: Fuente de alimentación redundante opcional (TFC-1600RP), se vende por separado.

Instalación del convertidor de fibra sobre un chasis

1. Destornille la tapa del compartimento deseado del chasis.

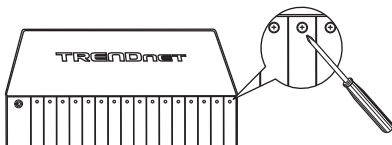

2. Afloje el tornillo de ajuste manual y saque el convertidor de la caja de metal.

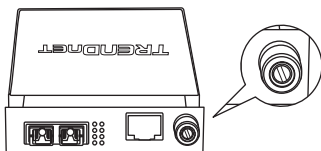

3. Inserte el convertidor de medios en una ranura disponible y apriete el tornillo de ajuste manual.

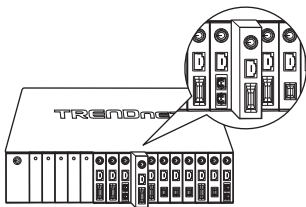

La instalación ha sido completada

Certifications

This device complies with Part 15 of the FCC Rules. Operation is subject to the following two conditions:
(1) this device may not cause harmful interference, and
(2) this device must accept any interference received.
Including interference that may cause undesired operation.



Waste electrical and electronic products must not be disposed of with household waste. Please recycle where facilities exist. Check with your Local Authority or Retailer for recycling advice.

- This equipment has been tested and found to comply with the limits for a Class A digital device, pursuant to part 15 of the FCC Rules. These limits are designed to provide reasonable protection against harmful interference when the equipment is operated in a commercial environment. This equipment generates, uses, and can radiate radio frequency energy and, if not installed and used in accordance with the instruction manual, may cause harmful interference to radio communications. Operation of this equipment in a residential area is likely to cause harmful interference in which case the user will be required to correct the interference at his own expense.
- FCC Caution: Any changes or modification not expressly approved by the party responsible for compliance could void the user's authority to operate this equipment.

Technical Support

If you have any questions regarding the product installation, please contact our Technical Support.
Toll free US/Canada: **1-866-845-3673**
Regional phone numbers available at www.trendnet.com/support

TRENDnet

20675 Manhattan Place
Torrance, CA 90501
USA

Power supply connected caution

The equipment power supply cord shall be connected to a socket-outlet with earthing connection.

Advertencia

Le cordon d'alimentation de l'appareil doit être raccordé à une prise de courant avec mise à la terre.

Note

The Manufacturer is not responsible for any radio or TV interference caused by unauthorized modifications to this equipment. Such modifications could void the user's authority to operate the equipment.

Advertencia

En todos nuestros equipos se mencionan claramente las características del adaptador de alimentación necesario para su funcionamiento. El uso de un adaptador distinto al mencionado puede producir daños físicos y/o daños al equipo conectado. El adaptador de alimentación debe operar con voltaje y frecuencia de la energía eléctrica domiciliar existente en el país o zona de instalación.

Product Warranty Registration

Please take a moment to register your product online. Go to TRENDnet's website at: www.trendnet.com/register