

TEW-P21G

54Mbps 802.11g Multi-Port Print Server
2 USB 2.0 & 1 Parallel Printer Port

User's Guide



Copyright ©2004. All Rights Reserved. TRENDware International, Inc.

TABLE OF CONTENTS

ABOUT THIS GUIDE	4
1. INTRODUCTION	5
PACKAGE CONTENTS	6
SYSTEM REQUIREMENTS	6
GENERAL FEATURES	7
PRODUCT VIEW	8
2. HARDWARE INSTALLATION	10
NETWORKING APPLICATION	10
INSTALLING THE PRINT SERVER	11
3. USING THE UTILITIES	12
AUTO-RUN INSTALLATION	12
PS-UTILITY	14
<i>Installing PS-Utility</i>	14
<i>Using PS-Utility</i>	15
PS WIZARD	18
4. PRINTING IN MAC OS	21
RENDEZVOUS USES IN MAC OS 10.2	21
SETTING UP APPLE TALK/LPR PRINTING	24
<i>For MAC OS X User</i>	24
<i>For MAC OS 9 User</i>	27

5. WEB CONFIGURATION.....	30
WEB CONFIGURATION UTILITY.....	30
MANAGEMENT.....	31
<i>Management</i> → <i>System</i>	32
<i>Management</i> → <i>Wireless</i>	33
<i>Management</i> → <i>Network</i>	34
<i>Management</i> → <i>User</i>	36
CONFIGURATION.....	37
<i>Configuration</i> → <i>System</i>	37
<i>Configuration</i> → <i>Wireless</i>	39
<i>Configuration</i> → <i>Network</i>	41
<i>Configuration</i> → <i>User</i>	43
<i>Configuration</i> → <i>E-mail</i>	44
<i>Configuration</i> → <i>SNMP</i>	46
TOOLS.....	47
<i>Tool</i> → <i>Print Test</i>	47
<i>Tool</i> → <i>E-mail</i>	48
<i>Tool</i> → <i>Reset</i>	49
<i>Tool</i> → <i>Factory Reset</i>	50
<i>Tool</i> → <i>Firmware Upgrade</i>	51
<i>Tool</i> → <i>Backup</i>	52
HELP.....	53
 PRODUCT SPECIFICATIONS	 54

ABOUT THIS GUIDE

This manual provides instructions and illustrations on how to use your Wireless Print Server, including:

- Chapter 1, **Introduction**, provides the general information on the product.
- Chapter 2, **Hardware Installation**, describes the hardware installation procedure for the product.
- Chapter 3, **Using the Utilities**, helps you to install and use the software.
- Chapter 4, **Printing in MAC OS**, lets you complete printing task through your print server in MAC OS environment.
- Chapter 5, **Web Configuration**, completes the configuration using the web browser.
- Chapter 6, **Product Specification**.

Please note that the illustrations or setting values in this manual are **FOR YOUR REFERENCE ONLY**. The actual settings and values depend on your system and network. If you are not sure about the respective information, please ask your network administrator or MIS staff for help.

1

INTRODUCTION

Congratulations on purchasing your Wireless Print Server, the easiest and fastest way to deploy printers on your network.

This compact print server can connect your network through an Access Point under the infrastructure mode, or can be used in ad-hoc mode for direct communication between PC/Notebook and print server anywhere you wish to locate wireless printer services. It manages the flow of print files from your workstation or file server to its connected printers, delivering print jobs to high-performance printers much faster than a file server or a PC acting as a print server can.

The Wireless Print Server features a Web-based Configuration Utility, which allows you to set up the print server through the web browser easily and quickly. It also includes a powerful software utility **PS-Utility**, a user-friendly program that allows you to complete further settings for the print server.

Package Contents

Unpack the package and check all the items carefully, and be certain that you have:

- ◆ One Wireless Print Server.
- ◆ One AC Power Adapter suitable for your country's electric power service.
- ◆ One Quick Installation Guide.
- ◆ One Installation CD-ROM containing the PS-Utility program and the User's Guide.

If any item contained is damaged or missing, please contact your local dealer immediately. Also, keep the box and packing materials in case you need to ship the unit in the future.

System Requirements

- ◆ Operating System:
 - Microsoft Windows 95/98/ME/NT/2000/XP/2003.
 - Apple Mac OS (with Apple Talk support).
- ◆ For Web Configuration:
 - Java-enabled web browser, such as Microsoft® Internet Explorer 5.0 and Netscape Navigator 6.0.

General Features

- ◆ Equipped with 1 parallel port and 2 USB ports allows user to share three printers on LAN simultaneously.
- ◆ Compliant with USB 2.0 High-speed printing.
- ◆ Equipped one 10/100 auto-MDIX Fast Ethernet LAN port.
- ◆ Multi protocol support is ideal for shared printing in mixed-LAN environments.
- ◆ Windows-based administrative program makes it possible to set up in a few steps.
- ◆ Latest MIB-II (RFC 1213) for SNMP standard management.
- ◆ Offer LPR program for Windows 95/98/Me TCP/IP printing.
- ◆ IP assignment support for DHCP, BOOTP and RARP.
- ◆ Support Web configuration.
- ◆ Provide Flash memory for easy firmware upgrade.
- ◆ Highly efficient design mechanism to provide unbeatable performance achieving data rate up to 54Mbps for 802.11g and 11Mbps for 802.11b with wide range coverage.
- ◆ Printing Access control and display.
- ◆ E-mail notification for printer error messages.
- ◆ Support E-Mail printing and FTP printing.
- ◆ Ability to save print server configuration into hard drive for easy access and backup without the hassle to reconfigure if setting is altered.
- ◆ Support IPP printing for Windows 2000/XP.
- ◆ Support second http port for remote web configuration and IPP printing.
- ◆ Support UPnP (Universal Plug and Play) for Windows XP.
- ◆ Support Mac OS 10.2 “Rendezvous” zero-configuration function.

Product View

This section describes the externally visible features of the print server.

Front View



Rear View

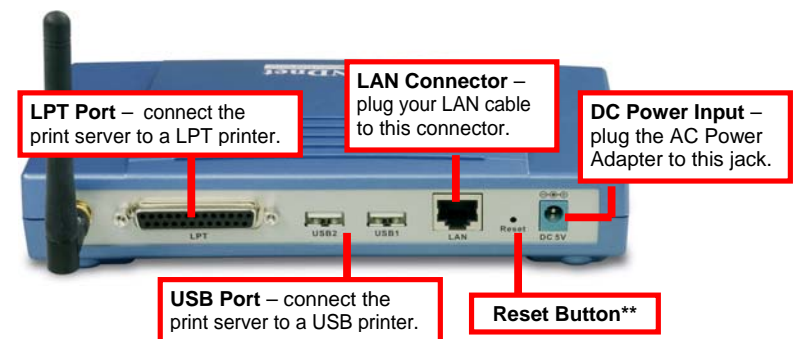

* There are six green LED indicators on the front panel:

LEDs	Description
Power	Steady light confirms that the Print Server is powered on.
USB1	When it blinks, the printer connected is printing.
USB2	When it blinks, the printer connected is printing.
LPT	When it blinks, the printer connected is printing.
LAN	Steady light confirms that the print server has a good connection to your network. When it blinks (briefly dark), the print server is receiving/ transmitting data from/to the network.
WLAN	Steady light confirms that the print server has a good connection to your wireless network. When it blinks (briefly dark), the print server is receiving/ transmitting data from/to the wireless network.

** 1) Press and release this button to reset the print server; or 2) Press and hold this button for three seconds (the USB LED on the front panel lights up) and then release it, the print server will resume the factory default settings.

2

HARDWARE INSTALLATION

Networking Application

The following diagram explains the application of your print server.

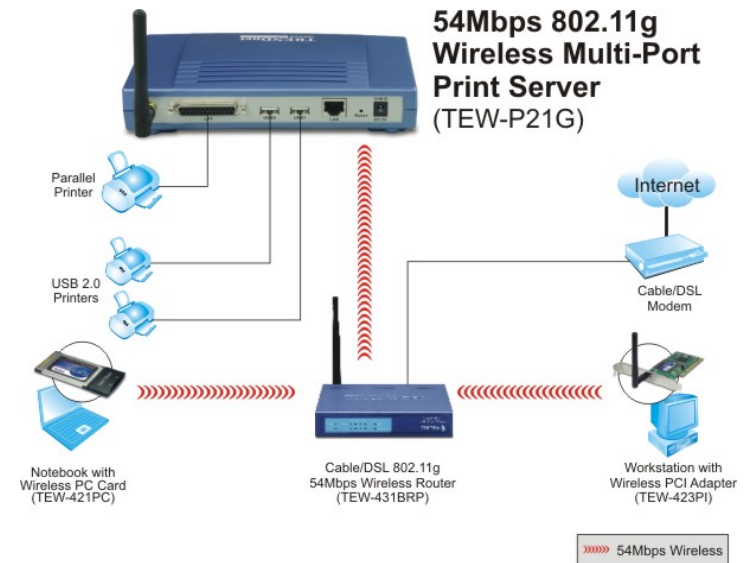

Installing the Print Server

Follow these steps for a trouble-free start of print server operations with your Wireless Print Server.

1. Confirm proper operation of the printer to be connected to the print server.
2. When you have confirmed proper operation of the printer, turn off the power.
3. Confirm that your network is operating normally.
4. Connect the print server to the network (through the RJ-45 connector of the print server).
5. While the printer is powered off, connect the print server to the printer's USB or Parallel port.
6. Turn on the printer's power.
7. Connect the DC end of the AC Power adapter to the DC power input socket of the print server and the AC end to the wall outlet. This will supply power to the print server immediately.

NOTE: This print server is built with a default IP Address. To prevent from any conflict in your network, it is recommended to use the PS-Utility program to change the IP setting when there is some other device's IP Address is the same as the print server's default IP Address.

3

USING THE UTILITIES

This chapter describes the software utilities for the print server, including how to set up your print server with these utility. The **PS-Utility** and **PS Wizard** are designed with a user-friendly interface that allows you to set up and administer the print server easily.

Auto-Run Installation

Insert the Installation CD-ROM into your computer's CD-ROM drive to initiate the Auto-Run program, and the menu screen will appear as below.

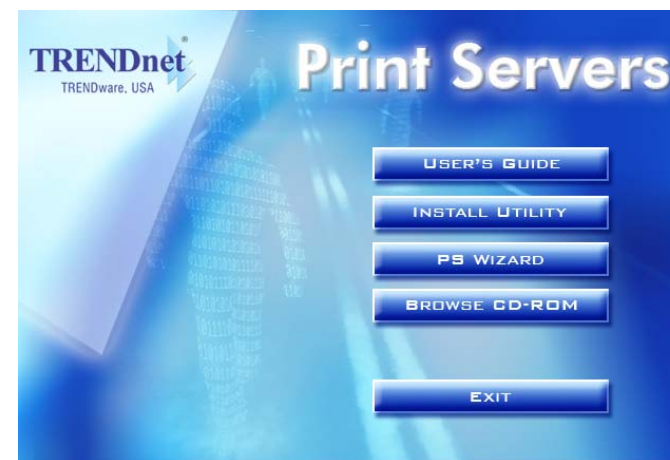

- **User's Guide** – click to preview the *User's Guide* in PDF format for detailed information of the Wireless Print Server.
- **Install Utility** – click to install PS-Utility. Please refer to the next section for detailed information on installing the utility.
- **PS Wizard** – click to launch the Printer Wizard program, which is helpful to set up the printer configuration easily and quickly.
- **Browse CD** – if you want to browse the contents of the Installation CD-ROM, click this button and the contents of the CD will be available for preview.
- **Exit** – click to close the Auto-Run program.

PS-Utility

To avoid the conflict in your network, you can use PS-Utility to change the related settings of your print server (such as the IP address) after finishing the installation.

Installing PS-Utility

1. Click **Install Utility** from the Auto-Run menu screen. Once executed, the Setup program will extract files to launch the InstallShield Wizard; then, click **Next >** in the welcome screen of InstallShield Wizard.

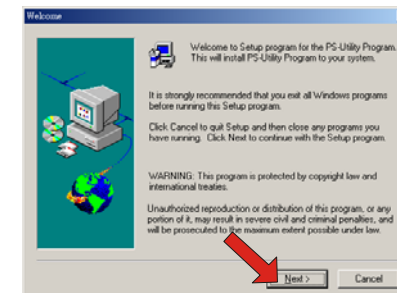

2. Choose the destination location. If no specific requirement, leave the default setting and click **Next >**.

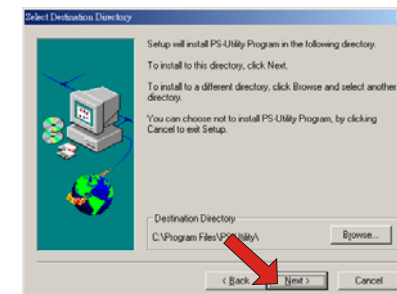

3. The InstallShield Wizard starts to install the software, and the Progress bar indicates the installation is proceeding.
4. When completed, click **Finish**.

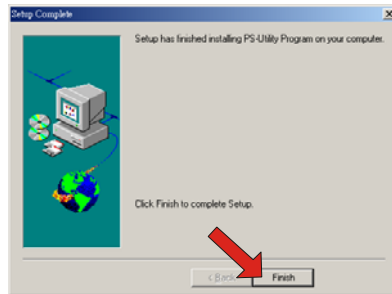

After installing the utility, the application program for the print server is automatically installed to your computer, and creates a folder in **Start\Programs\PS-Utility**.

Using PS-Utility

This section describes the operation of PS-Utility. To launch PS-Utility:

1. Click **Start -> Programs -> PS-Utility**, and then click the **PS-Utility v2.00** item.

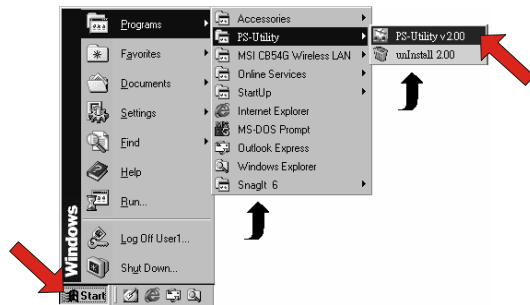

2. The main screen will appear as below, and it starts to search the connected print server within the network.

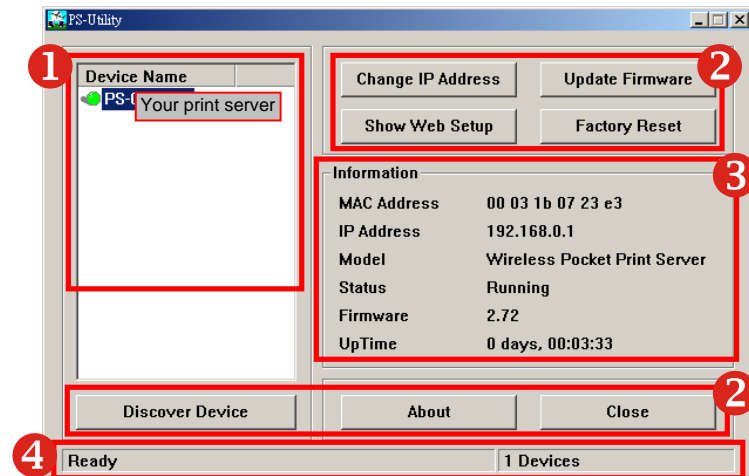

Component Features:

- 1 **Device List:** Display the connected print server within the network.
- 2 **Control Buttons**
 - **Change IP Address:** Click this button to bring up the following dialog box, allowing you to change the IP Address. In this dialog box, you can select either *Manually Assign* or *DHCP Assign Automatically*. When completed, click **OK**.
 - **Update Firmware:** Click this button to update the firmware of the selected print server.

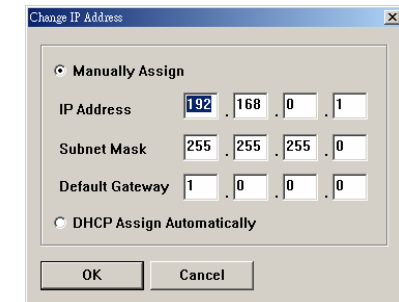

- **Show Web Setup:** Click this button to open your web browser and launch the Configuration Utility. Alternately, you can double-click the print server in the Device List to launch the Configuration Utility.
- **Factory Reset:** Click this button to reload the factory settings of the print server.
- **Discover Device:** Click this button to search the connected print server again.
- **About:** Click this button to bring up a window containing the basic information of PS-Utility.
- **Close:** Click this button to exit PS-Utility.

3 Information Field: Display the basic information of the selected print server in the Device List.

4 Status Bar: Display the system status.

PS Wizard

PS Wizard is a convenient utility that allows you to set up the print server's port connection.

To launch PS Wizard:

1. Insert the Installation CD-ROM into your computer's CD-ROM drive, and click **PS Wizard** from the Auto-Run menu screen. The welcome screen appears as below. Click **Next >**.



NOTE: For some specific printers, you may need to connect the printer to the computer and install the driver. In this case, connect it to the computer and install the driver first, and then connect it to the print server.

2. In the following window, select one printer in the Printer List to set up port connection, and then click **Next >**.

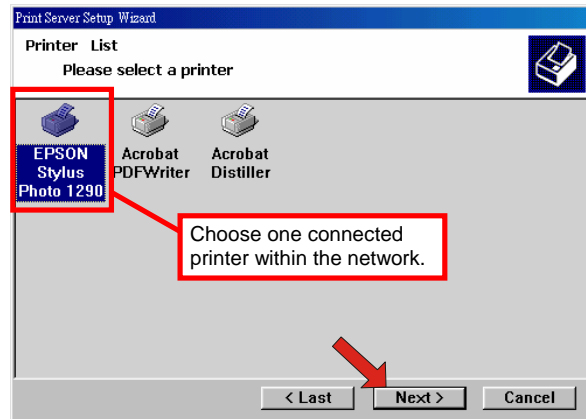

3. Select one printer port in the Print Server List, and click **Next >**.

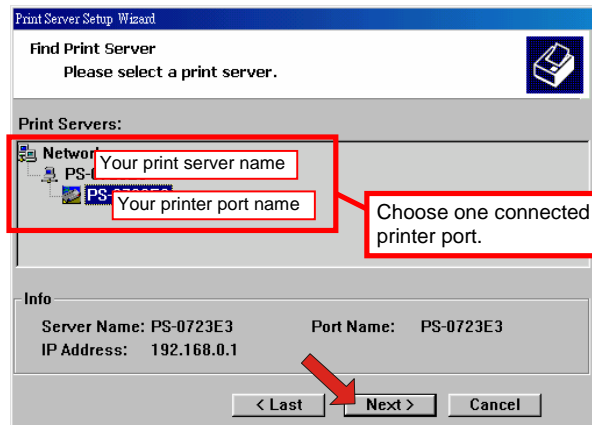

4. The configuration is completed, click **Reboot** and then **Yes** to restart the system.

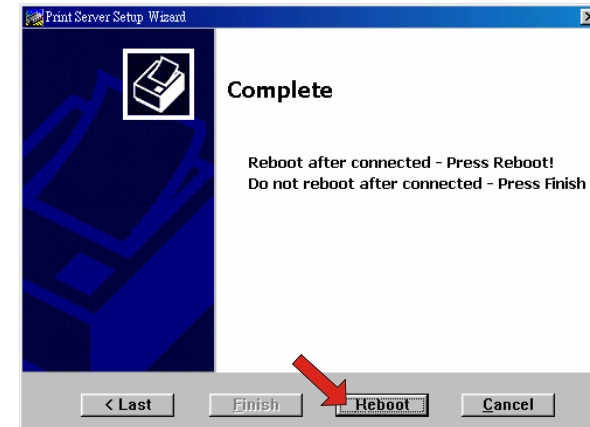

After rebooting, PS Wizard will help you to complete the port connection automatically. You can start your printing task without any complex configuration.

TIP: If you use Windows 2000/XP, the system will not restart to complete the installation.

4

PRINTING IN MAC OS

Rendezvous Uses in MAC OS 10.2

The latest version of MAC OS provides a new feature that is called **Rendezvous**. Rendezvous is a revolutionary networking technology standard that lets you create an instant network of computers and devices, which can be used throughout Mac OS 10.2 to provide innovative ways to share files and printers and even contact other people on the network.

For the printer connection, the Mac OS 10.2 Print Center application uses Rendezvous to discover Rendezvous-enabled printers on the network. When you add your computer to a network, Print Center automatically discovers the available printers. All you have to do is selecting the one you want to use and then start printing. You can add a new printer to the network and all the users on the network will see the new printer automatically appear in their Print Center, without any configuration.

The following instructions provide a common procedure of installing the printer:

1. Launch Print Center. Press and hold the Option key, click the **Add** button.

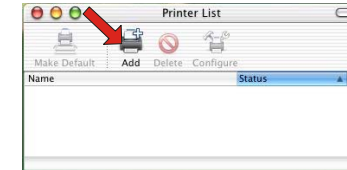

2. Select **Rendezvous** from the pop-up menu.

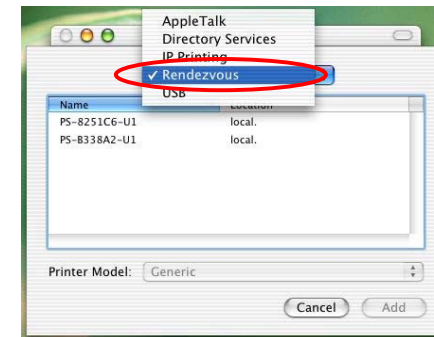

3. When clicking the **Rendezvous** item, the following window appears to display the connected Rendezvous-enabled printers.

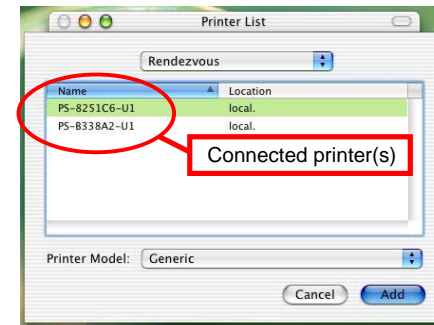

4. Select the desired printer, and the following pop-up menu displays the printer's manufacturer. Select **Generic**.

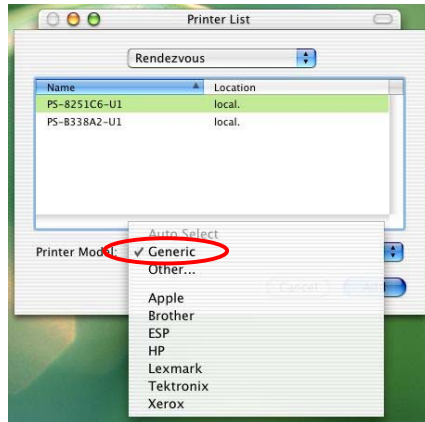

5. The printer is installed into the system successfully.

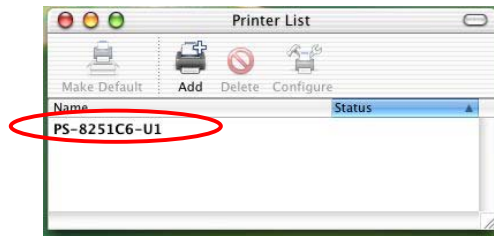

Setting Up Apple Talk/LPR Printing

For MAC OS X User

With MAC OS X, you can use AppleTalk or LPR printers to print through the print server. Follow the instructions below for setting up the print server:

1. After attaching the print server to your network, change the IP Address of your Macintosh computer to access the print server's web configuration. The default IP Address of the print server is **192.168.0.1**. Change your IP Address to **102.168.0.x**, where **x** is any number between 2 and 254.
2. Open the **System Preference** window and click **Network**. In the Network window, select the **AppleTalk** tab and check the **Make AppleTalk Active** option.

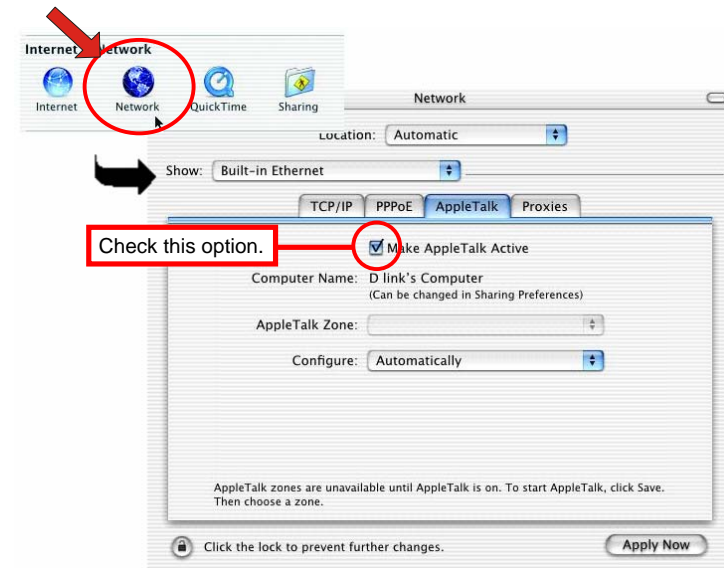

3. To print, open a document and select **File > Print** from the menu.

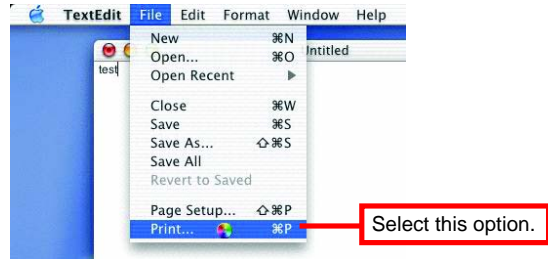

4. Select **Edit Printer List** from the **Printer** dialog box.

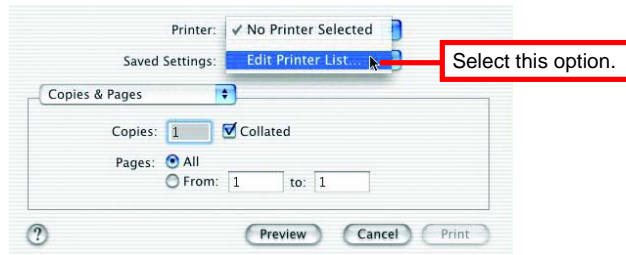

5. Click **Add Printer**. Then, select the desired printing protocol (*AppleTalk* or *LPR Printers using IP*).

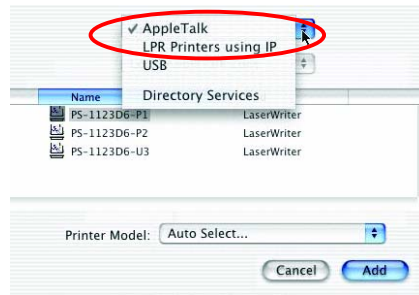

- **AppleTalk:** After selecting **AppleTalk**, the Port Name of the print server will be displayed. Select the Port to which the post-script printer is connected. Then, select the printer model from the dialog box. Click **Add Printer** to complete the Printer Port configuration. Select the Printer Port just configured in the Print window. Click **Print** to print your document.
- **LPR Printers using IP:** When you select **LPR Printers using IP Protocol**, type the IP Address of the print server into the **LPR Printer's Address** field of the following window. In the **Queue Name** field, type in the Port Name of the post-script printer that is connected to the Print Server. Select the printer model from the dialog box, and select the printer model from the pull-down menu. Click **Add** to complete the process. Close all Print Center windows and select the Printer Port that was just selected. Then, click **Print** to print the document.

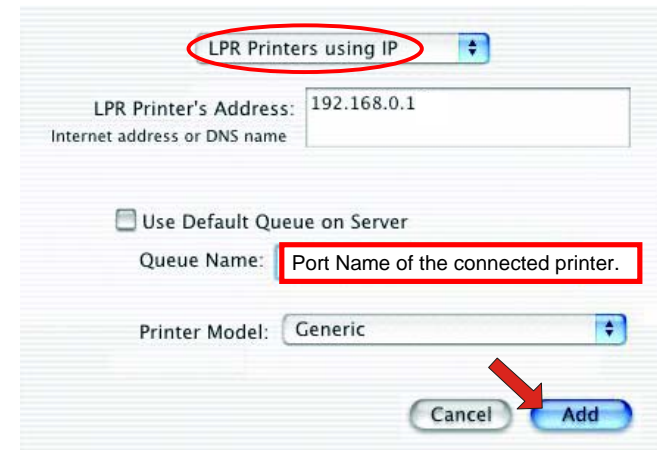

For MAC OS 9 User

If you use MAC OS 9, you can use the AppleTalk network protocol for network communications over standard Ethernet or Fast Ethernet using the EtherTalk transport, or over a proprietary low-speed LocalTalk transport. Your print server can be used for network printing to PostScript printers. You can print from any MAC OS computer connected to your Ethernet network, either directly using an EtherTalk connection or indirectly through a LocalTalk-to-EtherTalk router.

To set up the print server to be used for AppleTalk printing:

1. Please confirm that the AppleTalk protocol is enabled in your Macintosh computer.
2. Change the IP Address on one of the computers within your network to **192.168.0.x** (where *x* is any number between 2-254).
3. Type **192.168.0.1** (the default IP Address) into the address field of your browser.
4. Select the **Network** tab and scroll to the AppleTalk protocol section.
5. If your AppleTalk network is divided into AppleTalk zones, you have to specify which zone the Print Server should be in. You should locate the print server in the same zone as most of the users who will be using it. If your network is not divided into zones, it should contain a single asterisk “*”.

To print from MAC OS Client Workstations:

The actual settings of selecting a PostScript printer connected to your print server may be different from the instructions provided in this section, depending on the devices and the software you are using.

1. To choose a printer connected to your print server as your MAC OS workstation’s default printer, select **Chooser** from the Apple menu.
2. In the left column of **Chooser** window, select the desired item. Please confirm that AppleTalk is set to **Active**. A list of all networked PostScript printers will be displayed within the right column.

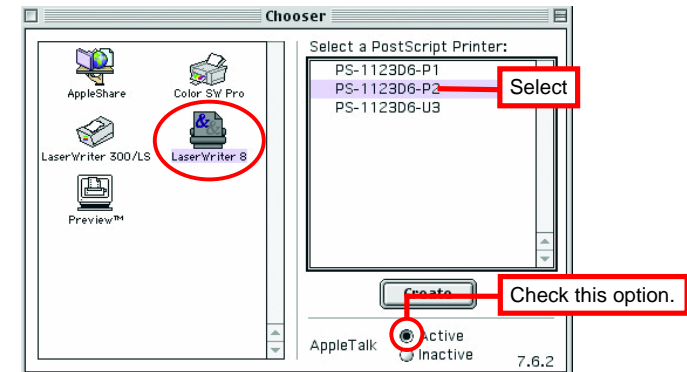

3. Double-click the name of the **Printer Port** you wish to use. The **Printer Ports** shown are examples only.

4. If you have not previously set this printer as the default, your computer will prompt you for a PostScript Printer Description file. Choose **Select PPD**.

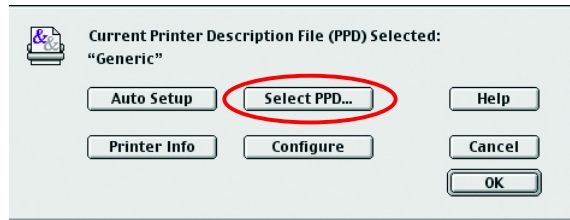

5. Select the appropriate printer description file for your printer. Click **Open**. (If your printer is not listed, click **Generic** to use a generic printer description.)

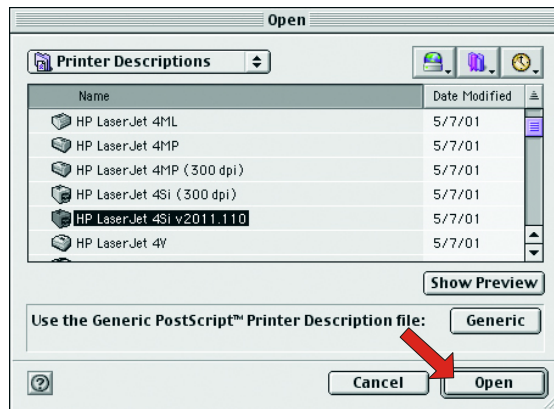

The selected printer will become your computer's default printer. You may need to choose **Page Setup** in any applications you have open.

WEB CONFIGURATION

You can access and manage the Wireless Print Server through: 1) the enclosed software PS-Utility, and 2) a web browser. This chapter describes the second method – the Web Configuration Utility, and explains how to set up your print server with the web browser.

Web Configuration Utility

First, launch your web browser (such as the Internet Explorer 6.0 used in this manual). Then, type *http://192.168.0.1* (the default IP address) in the Address bar and press [Enter] to enter the Management screen of the Configuration Utility.

TIP: The computer's IP address must correspond with the print server's IP address in the same segment for the two devices to communicate. Extensive knowledge of LAN will be helpful in configuring the print server.

Management



The Management Screen of the Configuration Utility

The Management screen displays the basic information of the print server, including the following four categories:

- **System**
- **Wireless**
- **Network**
- **User**

Management → System

As shown above, the **System** displays the status of your print server, printer, and network. Clicking **Refresh** will update the information.

Device Status

The information about the print server, including the firmware version, MAC/IP address, and up time, can be found in this field.

Printer Status

The items in this field display the information of the printer, such as the given name for the printer, speed, printer status, and status of your printing tasks, etc.

Ethernet Status

You can monitor the networking status in this field, including the network connection, speed, and the packets status.

Management → Wireless

Click the **Wireless** item in the left column to display the information of the wireless LAN. Clicking **Refresh** will update the information.

The screenshot shows the TRENDnet TEW-P21G web interface. The top navigation bar includes 'Management', 'Configuration', 'Tools', and 'Help'. The left sidebar has 'Management' selected, with sub-items for 'System', 'Wireless', 'Network', and 'User'. The main content area displays the 'Wireless Status' page with the following information:

Connection Mode	: Infrastructure
Link	: No
SSID	: LAB411 (MAC : 00 00 00 00 00 00)
Channel	: 11
Transmission Rate	: 54M bps
WEP Encryption	: Disable
Tx Packets	: 0
Tx Errors	: 0
Rx Packets	: 0
Rx Errors	: 0

A 'Refresh' button is located at the bottom of the status area.

Wireless Status

The items in this field display the information of the wireless LAN, such as the connection mode (Infrastructure or Ad-Hoc), SSID, channel, data transfer rate, WEP encryption, and the packets status.

Management → Network

Click the **Network** item to display the information of the LAN. Clicking **Refresh** will update the information.

The screenshot shows the TRENDnet TEW-P21G web interface. The top navigation bar includes 'Management', 'Configuration', 'Tools', and 'Help'. The left sidebar has 'Management' selected, with sub-items for 'System', 'Wireless', 'Network', and 'User'. The main content area displays the 'Network' page with the following information:

Auto IP		
DHCP/BOOTP	: Disable	(IP : 0.0.0.0)
UPnP	: Enable	(IP : 192.168.1.1)
MAC Rendezvous	: Enable	(IP : 169.254.119.57)
TCP/IP Printing		
LPR Printing	: Status	: Running
	Total Print Jobs	: 0
	Total Print Size	: 0 KBytes
Port (9100/9101/9102) Printing	: Status	: Running
	Total Print Jobs	: 0
	Total Print Size	: 0 KBytes
IPP Printing	: Status	: Running
	Total Print Jobs	: 0
	Total Print Size	: 0 KBytes
FTP Printing	: Status	: Running
	Total Print Jobs	: 0
	Total Print Size	: 0 KBytes
E-mail Printing	: Status	: Running
	Total Print Jobs	: 0
	Total Print Size	: 0 KBytes
Microsoft Network Printing		
SMB (Over NetBEUI) Printing	: Status	: Running
	Total Print Jobs	: 0
	Total Print Size	: 0 KBytes
SMB (Over NBT) Printing	: Status	: Running
	Total Print Jobs	: 2
	Total Print Size	: 46 KBytes
MAC AppleTalk Printing		
AppleTalk Printing	: Status	: Running
	Total Print Jobs	: 0
	Total Print Size	: 0 KBytes

A 'Refresh' button is located at the bottom of the network information area.

Auto IP

This field contains the current settings of TCP/IP, including DHCP/BOOTP, UPnP, and MAC Rendezvous. The items in this field are configured in **Configuration > Network > TCP/IP**.

TCP/IP Printing

In this field, you can monitor the status of your printing tasks through TCP/IP.

Microsoft Network Printing

In this field, you can monitor the status of your printing tasks through Microsoft Network.

MAC AppleTalk Printing

In this field, you can monitor the status of your printing tasks through MAC AppleTalk.

Management → User

Click the **User** item in the left column to display the user(s) information.

The screenshot shows the TRENDnet TEW-P21G web interface. The top navigation bar includes 'Management', 'Configuration', 'Tools', and 'Help'. The left sidebar has a menu with 'Management', 'System', 'Wireless', 'Network', and 'User' (which is highlighted). The main content area displays the 'Users Printing Log' table with the following data:

	MAC	IP	Name	Jobs	Size(kBytes)
1	00 E0 4C 39 02 99	192.168.1.100	ANTHONY	3	47

Below the table is a 'Refresh' button.

Users Printing Log

The items in this field display the user(s) information, which include the user(s) MAC address, IP address, name, and status of printing tasks.

Configuration

Configuration → System

TRENDnet TEW-P21G
TRENDware, USA

Management Configuration Tools Help

Configuration

System Device

Server Name : PS-567739

Location :

Admin Contact :

Password : New Password :

Confirm Again :

Port Setting

USB1 : Port Name : PS-567739-U1

Description :

P.J.L Printer : No

USB2 : Port Name : PS-567739-U2

Description :

P.J.L Printer : No

LPT3 : Port Name : PS-567739-P3

Description :

Speed : High

P.J.L Printer : No

Save Cancel

System Device

In this field, you can configure the basic information of your print server.

- **Server Name:** Assign a name to the print server.
- **Location** (optional): Assign a location for the print server

- **Admin Contact** (optional): Assign the Admin Contact's name for the print server.
- **Password:** Enter the Administrator password (3-8 characters). To set up the password, please enter the password in the *New Password* box, and then enter the same one again in the *Confirm Again* box.

Port Settings

In this field, you can assign the *Port Name* for the print server, and the description for the USB port. It also allows you to select the **PJL Printer** setting (*Yes* or *No*).

NOTE: P.J.L (Print Job Language) has certain job requirements that must be met to work correctly. For more information, please refer to your printer's manual.

Configuration → Wireless

The screenshot shows the configuration page for the TRENDnet TEW-P21G device. The page is titled "Configuration → Wireless" and has a navigation bar with "Management", "Configuration", "Tools", and "Help". The left sidebar shows a menu with "Configuration" selected, and sub-items for "System", "Wireless", "Network", "User", "E-mail", and "SNMP". The main content area is divided into three sections: "Wireless Interface", "WEP Encryption", and "Advanced Setting".

Wireless Interface

- Connection Mode: Infrastructure, Ad-Hoc
- SSID: LAB411 (Manually Input or Select from List)
- Wireless Channel: 11
- Transmission Rate: Fully Automatic

WEP Encryption

- WEP Encryption: Disable, 64 bits, 128 bits
- WEP Key Format: ASCII, HEX
- Key 1: [Empty text box]
- Key 2: [Empty text box]
- Key 3: [Empty text box]
- Key 4: [Empty text box]
- Encrypt Data Transmissions Using: Key 1

Advanced Setting

- Beacon Interval: 100 (ms)
- Preamble: Long, Short
- Authentication Type: Open System, Shared Key, Both

Buttons: Save, Cancel

Wireless Interface

- **Connection Mode:** Select one of the three connection modes.
 - **Infrastructure** (default) - Connects to compatibly configured wireless AP or router in a WLAN.
 - **Ad-Hoc** - Connect to compatibly configured wireless clients in the peer-to-peer mode.
- **SSID:** Assign the SSID in this box. You can manually input the name or select one from the pull-down menu. To search the

available wireless AP within the network, click the **Site Survey** button.

- **Wireless Channel:** Select the channel from the pull-down menu. The default setting is **11**.
- **Transmission Rate:** Select the data transmit rate from the pull-down menu. The default setting is **Fully Automatic**.

WEP Encryption

This field allows you to configure the settings of data encryption. Please remember that the WEP key must be set before the data encryption is enforced.

- **WEP Encryption:** This option allows you to select **Disable**, **64 bits**, and **128 bits** for the encryption setting.
- **WEP Key Format:** You can decide the network key to be encoded by **ASCII** (ASCII characters) or **HEX** (hexadecimal digitals).

Then, enter the key(s) for the network in the **Key** box (1~4).

Advanced Setting

This field allows you to configure more settings, including:

- **Beacon Interval:** Enter the number of beacon interval time in millisecond.
- **Preamble:** This option allows you to set the length of preamble. Setting options are: **Long** - it is set to 144 bits; **Short** - it is set to 72 bits.
- **Authentication Type:** You can set the authentication type by selecting the settings: **Open System**, **Shared Key**, and **Both**.

TIP: Once you have changed the settings in each option, click **Save** to store the settings, or **Cancel** to abandon.

Configuration → Network



TEW-P21G

Management Configuration Tools Help

Configuration

System
Wireless
Network
User
E-mail
SNMP

TCP/IP

IP Address : Manually Assign
IP Address : 192.168.1.77
Subnet Mask : 255.255.255.0
Default Gateway : 192.168.1.254
 Automatically Assign

DNS Server Address : 1. 0.0.0.0
2. 0.0.0.0

UPnP : Enable Disable

MAC Rendezvous : Enable Disable

Second HTTP Port : Enable Disable
Port Number : 0
(For Remote Web Configuration and IPP Printing)

Microsoft Network

Workgroup : WORKGROUP

AppleTalk

AppleTalk Zone : *

USB1 : Chooser Name : PS-567739-U1
Printer Type : LaserWriter
PostScript Level : Level 2
Font Group : Standard 35

USB2 : Chooser Name : PS-567739-U2
Printer Type : LaserWriter
PostScript Level : Level 2
Font Group : Standard 35

LPT3 : Chooser Name : PS-567739-P3
Printer Type : LaserWriter
PostScript Level : Level 2
Font Group : Standard 35

Save Cancel

TCP/IP

This field contains three options that allow you to configure the TCP/IP setting: **IP Address**, **UPnP**, and **MAC Rendezvous**.

- **IP Address:** This option allows you to set the IP address manually or automatically. When you choose *Manually Assign*, you should enter the related information in the following boxes, including *IP Address*, *Subnet Mask*, and *Default Gateway*.
- **UPnP:** This option allows you to enable or disable UPnP mode.
- **MAC Rendezvous:** This option allows you to enable or disable MAC Rendezvous mode.

Microsoft Network

Enter the name of the Workgroup that you want the print server associated with in this field.

AppleTalk

Enter the AppleTalk Zone name in the box. In the following options, enter the related configuration, such as the printer type.

- **USB1, USB2, LPT3**
 - **Chooser Name:** Display the print server's Port name.
 - **Printer Type:** Enter the printer's type in this box.
 - **PostScript Level:** Select from the pull-down menu (*Level 1* or *Level 2*).
 - **Font Group:** Select from the pull-down menu.

TIP: Once you have changed the settings in each option, click **Save** to store the settings, or **Cancel** to abandon.

Configuration → User

Printing Control

Enable User Printing Control : Yes No

Allow Undefined Users Printing : Yes No

Save Cancel

Define Users

Add User : User Name : Add

MAC Address :

Printing Access : Yes No

Delete User : Delete

User List :

Name	MAC	Printing Access
------	-----	-----------------

Printing Control

By configuring the **Enable User Printing Control** option (*Yes* or *No*), the user in the User List is permitted to access the print server or not. For the user(s) who is not in the User List, you can also limit the access right by setting the **Allow Undefined Users Printing** option to *Yes* or *No*.

Define Users

You can add/delete the user(s) to/from the User List. The User List at the bottom of the screen displays the current defined user and related information for the print server.

TIP: Once you have changed the settings in each option, click **Save** to store the settings, or **Cancel** to abandon.

Configuration → E-mail

E-mail Account

Print Server E-mail Address :

Incoming E-mail (POP3) Server Address :

Outgoing E-mail (SMTP) Server Address :

Account Name :

Password :

E-mail Notification

Enable e-mail notification for printer status changing : Yes No

Notification e-mail will be sent to Admin's e-mail address.

Admin E-mail Address :

(Use "," to separate multiple e-mail address)

E-mail Printing (To USB1 Port)

E-mail Printing (ASCII Text Only) : Enable Disable

Receive E-mail Interval : (minutes)

Save Cancel

E-mail Account

You can assign an E-mail address to the print server, so that your mail of the account can be printed out directly through the printer (ASCII text only). To enable this function, enter the E-mail account in the **Print Server E-mail Address** box.

- **Incoming E-mail (POP3) Server Address:** Enter the server address that is used to receive your E-mail in this box.
- **Outgoing E-mail (SMTP) Server Address:** Enter the server address that is used to send your E-mail in this box.

If your mail server needs to verify the user when sending E-mail, you have to input the **Account Name** and **Password**.

E-mail Notification

You can set the print server to send an alter message when the printer status changes through E-mail. To enable this function, set the **Enable e-mail notification for printer status changing** option to *Yes*. Then, input the administrator's E-mail address in the **Admin E-mail Address** box.

E-mail Printing

- **E-mail Printing (ASCII Text Only):** Select *Enable* to enable the E-mail printing function.
- **Receive E-mail Interval:** Enter the number in this box to set up the time (in minute) to check/receive E-mail regularly.

*TIP: Once you have changed the settings in each option, click **Save** to store the settings, or **Cancel** to abandon.*

Configuration → SNMP

The screenshot shows the configuration interface for a TRENDnet TEW-P21G device. The top navigation bar includes 'Management', 'Configuration', 'Tools', and 'Help'. The left sidebar lists configuration categories: System, Wireless, Network, User, E-mail, and SNMP. The main content area is titled 'SNMP Management' and contains three community settings:

Community	Name	Access Right
Community 1	public	Read/Write
Community 2		Read Only
Community 3		Read Only

At the bottom of the form are 'Save' and 'Cancel' buttons.

SNMP Management

SNMP (Simple Network Management Protocol) is a set of protocols for managing complex networks

- **Community 1/2/3:** Enter a name in the **Name** box, and configure the **Access Right** by selecting *Read Only* or *Read/Write* from the pull-down menu.

*TIP: Once you have changed the settings in each option, click **Save** to store the settings, or **Cancel** to abandon.*

Tools

Tool → Print Test

The screenshot shows the TRENDnet TEW-P21G web interface. The top navigation bar includes Management, Configuration, Tools, and Help. The left sidebar lists Tools, Print Test, E-mail, Reset, Factory Reset, Firmware Upgrade, and Backup. The main content area is titled 'Print Test' and contains a 'Port Selection' section with three radio button options: USB1 (selected), USB2, and LPT3. A 'Test' button is located at the bottom of the configuration area.

Print Test

Choose one of the print ports and click **Test** to print a test page.

Tool → E-mail

The screenshot shows the TRENDnet TEW-P21G web interface. The top navigation bar includes Management, Configuration, Tools, and Help. The left sidebar lists Tools, Print Test, E-mail, Reset, Factory Reset, Firmware Upgrade, and Backup. The main content area is titled 'Test E-mail Account' and contains a 'Receive E-mail' section with a 'Yes' button. The 'Test E-mail Account' section contains the text: 'E-mail test will send an e-mail to Admin's e-mail address. Do you want to test e-mail account?' and a 'Test' button.

Test E-mail Account

Click **Test** to send a test E-mail to the given administrator's E-mail address.

Receive E-mail

Click **Yes** to immediately check and receive E-mail, and then print out the mail when available.

Tool → Reset

The screenshot shows the TRENDnet TEW-P21G web interface. At the top left is the TRENDnet logo with 'TRENDware, USA' below it. At the top right is the model number 'TEW-P21G'. Below the logo and model number is a navigation bar with links for 'Management', 'Configuration', 'Tools', and 'Help'. On the left side, there is a 'Tools' menu with the following items: 'Print Test', 'E-mail', 'Reset', 'Factory Reset', 'Firmware Upgrade', and 'Backup'. The 'Reset' item is highlighted. The main content area is titled 'Reset' and contains the question 'Do you want to reset this device?' followed by a 'Yes' button.

Reset

Click **Yes** to immediately reset the print server.

Tool → Factory Reset

The screenshot shows the TRENDnet TEW-P21G web interface. At the top left is the TRENDnet logo with 'TRENDware, USA' below it. At the top right is the model number 'TEW-P21G'. Below the logo and model number is a navigation bar with links for 'Management', 'Configuration', 'Tools', and 'Help'. On the left side, there is a 'Tools' menu with the following items: 'Print Test', 'E-mail', 'Reset', 'Factory Reset', 'Firmware Upgrade', and 'Backup'. The 'Factory Reset' item is highlighted. The main content area is titled 'Factory Reset' and contains the question 'Do you want to restore this device to factory default setting?' followed by a 'Yes' button.

Factory Reset

Click **Yes** to reload the factory settings of the print server.

Tool → Firmware Upgrade

The screenshot shows the TRENDnet TEW-P21G web interface. The top navigation bar includes 'Management', 'Configuration', 'Tools', and 'Help'. The 'Tools' menu is expanded, showing options like 'Print Test', 'E-mail', 'Reset', 'Factory Reset', 'Firmware Upgrade', and 'Backup'. The 'Firmware Upgrade' section is active, displaying the current firmware version and date as '3.13 (2004-11-08)'. Below this, there is a text input field labeled 'Select a Firmware File:' with a 'Browse...' button. At the bottom of the section are 'Upgrade' and 'Cancel' buttons.

Firmware Upgrade

When a new version of firmware is available (e.g. downloading from the manufacturer's website), you can upgrade the firmware of your print server. Click **Browse** to point to the firmware file, and then click **Upgrade**.

Tool → Backup

The screenshot shows the TRENDnet TEW-P21G web interface. The top navigation bar includes 'Management', 'Configuration', 'Tools', and 'Help'. The 'Tools' menu is expanded, showing options like 'Print Test', 'E-mail', 'Reset', 'Factory Reset', 'Firmware Upgrade', and 'Backup'. The 'Backup' section is active, displaying two options: 'Backup Device Configuration to File' and 'Restore Device Configuration from File'. The 'Backup Device Configuration to File' section has a 'Backup' button and a question 'Do you want to backup the configuration to file?'. The 'Restore Device Configuration from File' section has a text input field labeled 'Select a Configuration File:' with a 'Browse...' button, and 'Restore' and 'Cancel' buttons.

Backup Device Configuration to File

Click **Backup** to backup your current configuration of the print server to file and then save in the computer.

Restore Device Configuration from File

You can reload a configuration that you saved before. Click **Browse** to point to the backup file, and then click **Restore**.

Help

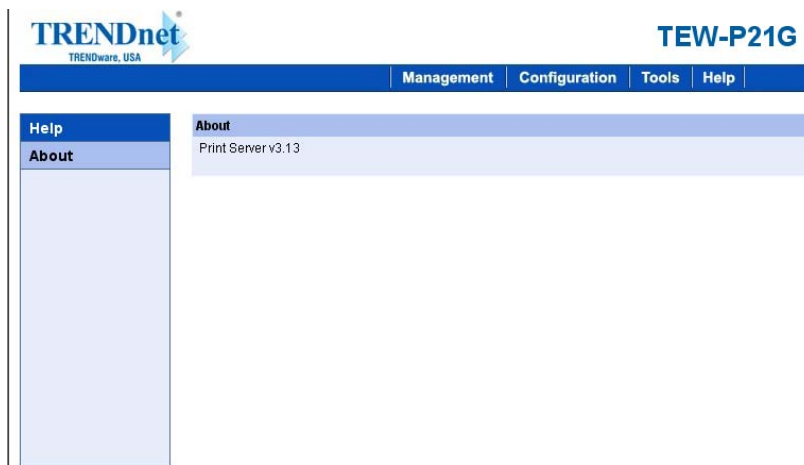

This screen displays the information of the print server.

6

PRODUCT SPECIFICATIONS

Printer Connection

Printer Interface: Two USB ports, compliant with USB 2.0 Hi-speed standard.

Network Connection

Wireless Networking

Network Standards: Wireless LAN standard IEEE802.11g.

Network Data Transfer Rate: 54Mbps with fallback to 48, 36, 24, 18, 12, 11, 9, 6, 5.5, 2, and 1Mbps.

Network Mode: Support both Infrastructure and Ad-hoc mode.

Wired Networking

Network Interface: One 10/100 Fast Ethernet port (RJ-45 connector).

Network Data Transfer Rate: 100Mbps.

Network Protocol Support

Transport Protocols: TCP/IP, SMB, NetBEUI, and AppleTalk.

TCP/IP Protocols Support: BOOTP, SNMP, Telnet, FTP, LPD, DHCP, and IPP.

Hardware

SDRAM: 8MB.

Flash ROM: 2MB.

Operating System Support

- Windows 95/98/ME, Windows NT, Windows 2000/XP/2003;
- NetWare 5.x (NDPS LPR remote printing);
- HP-UX Unix, Sun O.S, Solaris, SCO Unix, AIX;
- Unixware and Linux;
- Mac OS, AppleTalk.

Management

Standard: SNMP

MIBs: MIB-II (RFC 1213).

Utilities: PS-Utility, PS Wizard.

LEDs

Power, LAN, WLAN, USB1, USB2, LPT.

Environmental and Physical

Power Supply: 5VDC.

Operating Temperature: 0°C to 50°C.

Storage Temperature: -25°C to 55°C.

Humidity: 5% to 95%, non-condensing at 30°C.

EMI Compliance

FCC Class B, CE Class B, VCCI Class B

Limited Warranty

TRENDware warrants its products against defects in material and workmanship, under normal use and service, for the following lengths of time from the date of purchase.

Wireless Print Server – 3 Years Warranty

If a product does not operate as warranted above during the applicable warranty period, TRENDware shall, at its option and expense, repair the defective product or part, deliver to customer an equivalent product or part to replace the defective item, or refund to customer the purchase price paid for the defective product. All products that are replaced will become the property of TRENDware. Replacement products may be new or reconditioned.

TRENDware shall not be responsible for any software, firmware, information, or memory data of customer contained in, stored on, or integrated with any products returned to TRENDware pursuant to any warranty.

There are no user serviceable parts inside the product. Do not remove or attempt to service the product by any unauthorized service center. This warranty is voided if (i) the product has been modified or repaired by any unauthorized service center, (ii) the product was subject to accident, abuse, or improper use (iii) the product was subject to conditions more severe than those specified in the manual.

Warranty service may be obtained by contacting TRENDware office within the applicable warranty period for a Return Material Authorization (RMA) number, accompanied by a copy of the dated proof of the purchase. Products returned to TRENDware must be pre-authorized by TRENDware with RMA number marked on the outside of the package, and sent prepaid, insured and packaged appropriately for safe shipment.

WARRANTIES EXCLUSIVE: IF THE TRENDWARE PRODUCT DOES NOT OPERATE AS WARRANTED ABOVE, THE CUSTOMER'S SOLE REMEDY SHALL BE, AT TRENDWARE'S OPTION, REPAIR OR REPLACEMENT. THE FOREGOING WARRANTIES AND REMEDIES ARE EXCLUSIVE AND ARE IN LIEU OF ALL OTHER WARRANTIES, EXPRESSED OR IMPLIED, EITHER IN FACT OR BY OPERATION OF LAW, STATUTORY OR OTHERWISE, INCLUDING WARRANTIES OF MERCHANTABILITY AND FITNESS FOR A PARTICULAR PURPOSE. TRENDWARE NEITHER ASSUMES NOR AUTHORIZES ANY OTHER PERSON TO ASSUME FOR IT ANY OTHER LIABILITY IN CONNECTION WITH THE SALE, INSTALLATION MAINTENANCE OR USE OF TRENDWARE'S PRODUCTS.

TRENDWARE SHALL NOT BE LIABLE UNDER THIS WARRANTY IF ITS TESTING AND EXAMINATION DISCLOSE THAT THE ALLEGED DEFECT IN THE PRODUCT DOES NOT EXIST OR WAS CAUSED BY CUSTOMER'S OR ANY THIRD PERSON'S MISUSE, NEGLIGENCE, IMPROPER INSTALLATION OR TESTING, UNAUTHORIZED ATTEMPTS TO REPAIR OR MODIFY, OR ANY OTHER CAUSE BEYOND THE RANGE OF THE INTENDED USE, OR BY ACCIDENT, FIRE, LIGHTNING, OR OTHER HAZARD.

LIMITATION OF LIABILITY: TO THE FULL EXTENT ALLOWED BY LAW TRENDWARE ALSO EXCLUDES FOR ITSELF AND ITS SUPPLIERS ANY LIABILITY, WHETHER BASED IN CONTRACT OR TORT (INCLUDING NEGLIGENCE), FOR INCIDENTAL, CONSEQUENTIAL, INDIRECT, SPECIAL, OR PUNITIVE DAMAGES OF ANY KIND, OR FOR LOSS OF REVENUE OR PROFITS, LOSS OF BUSINESS, LOSS OF INFORMATION OR DATE, OR OTHER FINANCIAL LOSS ARISING OUT OF OR IN CONNECTION WITH THE SALE, INSTALLATION, MAINTENANCE, USE, PERFORMANCE, FAILURE, OR INTERRUPTION OF THE POSSIBILITY OF SUCH DAMAGES, AND LIMITS ITS LIABILITY TO REPAIR, REPLACEMENT, OR REFUND OF THE PURCHASE PRICE PAID, AT TRENDWARE'S OPTION. THIS DISCLAIMER OF LIABILITY FOR DAMAGES WILL NOT BE AFFECTED IF ANY REMEDY PROVIDED HEREIN SHALL FAIL OF ITS ESSENTIAL PURPOSE.

Governing Law: This Limited Warranty shall be governed by the laws of the state of California.

Technical Support

You can find the most recent driver/firmware/software and user documentations on the **TRENDware website**. **TRENDware** provides **FREE technical support** for all customers for the duration of the warranty period on this product.

TRENDware Technical Support

Tel: +1-310-626-6252

Fax: +1-310-626-6267

E-mail: support@trendware.com

www.TRENDnet.com

**Monday ~ Friday, 7:30AM ~ 6:00PM Pacific Standard Time
(Except holidays)**



Product Warranty Registration

Please take a moment to register your product online.
Go to TRENDware's website at <http://www.TRENDNET.com>

TRENDware International, Inc.

3135 Kashiwa Street

Torrance, CA 90505

<http://www.TRENDNET.com>

Copyright ©2004. All Rights Reserved. TRENDware International, Inc.