

# TRENDnet<sup>®</sup>



---

Quick Installation Guide  
TEW-840APB0 (v1x.R)

# Table of Contents

---

## **1 English**

1. Before You Start
2. Hardware Setup and Configuration
3. Hardware Installation

# 1. Before You Start

---

## Package Contents

- TEW-840APB0
- Quick Installation Guide
- Proprietary/Passive PoE injector (24V DC, 0.6A)
- Mounting Hardware

## Minimum Requirements

- Computer with a network port and web browser
- A network switch or router with an available network LAN port
- Additional TEW-840APB0 H/W: v1.xR wireless AC867 directional access point
- 4 x RJ-45 network cables

### **Note:**

The TEW-840APB0 does not support IEEE 802.3at/af PoE standards. You must use the proprietary/passive power over Ethernet injector that is supplied with the TEW-840APB0. This installation guide will walk you through the installation and configuration of two TEW-840APB0 access points to establish a wireless point to point bridge using WDS (wireless distribution system). The RJ-45 Ethernet cable between the passive PoE injector and access point can have a maximum length of up to 60 m (197 ft.).

## 2. Hardware Setup and Configuration

---

### **Note:**

- The default IP address of the TEW-840APB0 is 192.168.10.100. To configure the TEW-840APB0, your network adapter must have an IP address within the 192.168.10.x subnet (e.g. 192.168.10.10). Please refer to the Appendix in the User's Guide for more information.
- The initial configuration should be completed in a testing environment with two TEW-840APB0 access points approximately 15 ft. (5 m) apart from one another with the front of the access points directly facing each other.
- Configure and connect the access points before mounting.
- The configuration example in this guide will use the default/standard TEW-840APB0 channel access mode CSMA. More details can be found in the user's guide about TDMA channel access mode which is also supported by the TEW-840APB0 wireless AP.

### **Phase 1: Overview**

In this installation guide, we will assume the following:

Router Settings:

Router/Default Gateway IP address: 192.168.10.1  
Subnet Mask: 255.255.255.0

The TEW-840APB0 access points will be configured with the following settings:

#### **TEW-840APB0 #1**

IP Address: 192.168.10.50  
Netmask (Subnet Mask): 255.255.255.0  
IP Gateway (Default Gateway): 192.168.10.1  
Primary DNS: 192.168.10.1  
Wireless Channel Default: 48  
WDS Access Point Mode (CSMA)  
WPA2-PSK Encryption

#### **TEW-840APB0 #2**

IP Address: 192.168.10.51  
Netmask (Subnet Mask): 255.255.255.0  
IP Gateway (Default Gateway): 192.168.10.1  
Primary DNS: 192.168.10.1  
Wireless Channel Default: 48  
WDS Station Mode (CSMA)  
WPA2-PSK Encryption

## **Phase 2: TEW-840APB0 Unit #1 Hardware Setup and Configuration**

1. Remove the cover of the access point by pulling and holding the bottom tab in the vertical direction down (based on the access point orientation below) and sliding the cover below away from the access point.

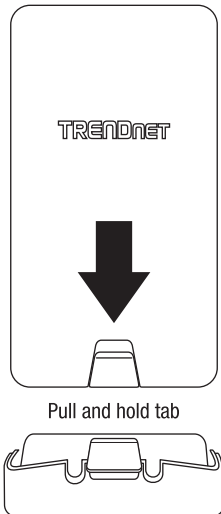

2. Write down the SSID and WPA2 Key of the TEW-840APB0 #1 access point. The SSID and WPA2 Key can be found on the inside of the device cover where the Ethernet LAN ports are located (shown below).

**Model:** TEW-840APB0 /A  
**IP Address:** 192.168.10.100  
**Subnet Mask:** 255.255.255.0  
**User Name:** admin  
**Password:** admin  
**Mode:** WDS AP  
**SSID:** TRENDnet840\_XXXX  
**WPA2 Key:** 840XXXXXXXXX  
**Default Channel:** 48

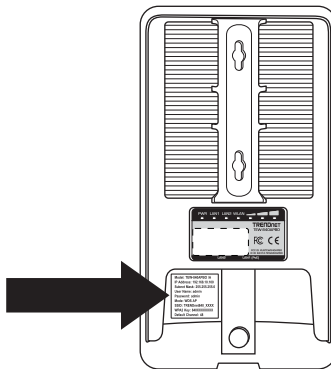

3. Using a network cable, connect one end of the cable to the LAN1 (PoE) port.

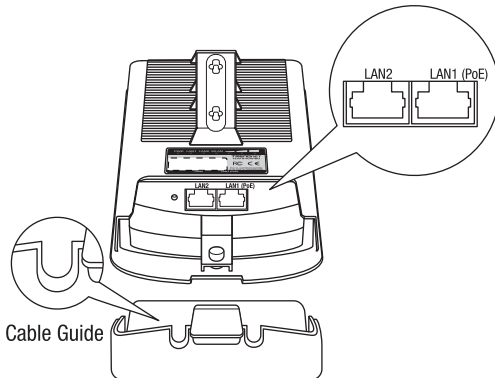

4. Connect the other end of the network cable to the **PoE** port on the included PoE injector.
5. Using another network cable, connect one end to the **LAN** port on the included PoE injector.
6. Connect the other end of the network cable to your computer's Ethernet port.
7. Attach the power cord to the PoE injector and plug the connected power cord into a power outlet.
8. Confirm the device is powered on through the LED indicators.

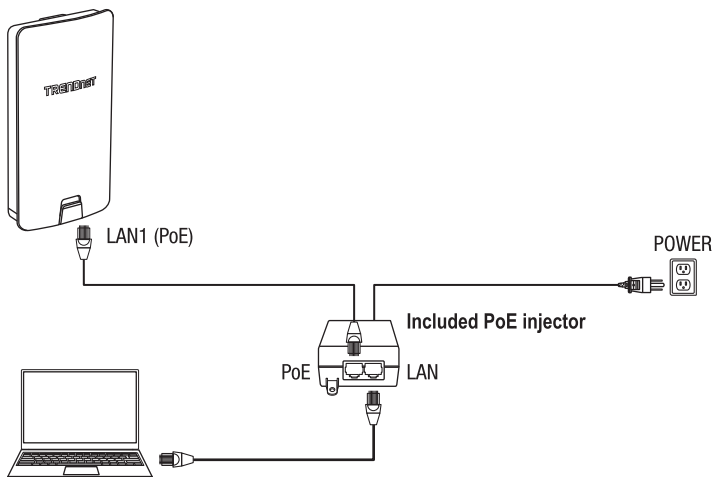

9. Assign a static IP address to your computer's network adapter in the subnet of 192.168.10.x (e.g. 192.168.10.10) and subnet mask of 255.255.255.0.
10. Open your web browser and type the IP address of the access point in the address bar, then press **Enter**. The default IP address is 192.168.10.100.



11. When prompted, login to the browser configuration page using the default user name and password settings.

User Name: **admin**

Password: **admin**

**Note:** User Name and Password are case sensitive.

The screenshot shows a login form titled "Please Login". It has two input fields: one for the username "admin" and one for the password "\*\*\*\*\*". A "Login" button is located below the fields. Callout boxes point to the "admin" text in the username field and the "\*\*\*\*\*" text in the password field.

12. In the left hand menu under **System Manager**, click on **Account**.

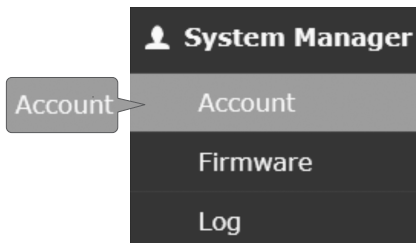

13. Under **Account Settings**, change the default administrator password by typing in the current password admin and your new password in the fields provided. Then click the **Apply** button to save the new password settings. You will be prompted to log back in with the new password settings.

#### Account Settings

Administrator Username	<input type="text" value="admin"/>
Current Password	<input type="password" value="*****"/>
New Password	<input type="password" value="*****"/>
Verify Password	<input type="password" value="*****"/>

Apply

Apply



14. After setting a new administrator password, in the left hand menu under **Network**, click on **Basic**.

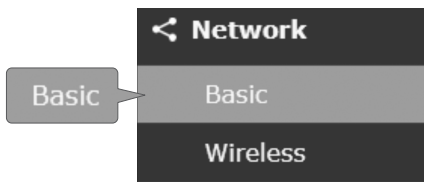

15. In the IPv4 Settings section, enter the IP Address **192.168.10.50** and Subnet Mask **255.255.255.0**, then click **Save** at the bottom of the page. When prompted to apply settings at the bottom right of the page, click **Apply** to commit the changes.

**Note:** When configuring TEW-840APB0 #2, enter the IP address settings 192.168.10.51 and Netmask 255.255.255.0.

#### IPv4 Settings

IP Network Setting	<input type="radio"/> DHCP <input checked="" type="radio"/> Static IP
IP Address	<input type="text" value="192.168.10.50"/>
Subnet Mask	<input type="text" value="255.255.255.0"/>

**Save** Save current setting(s)

Waiting for changes to be applied (2)

**Apply** **Revert**

### Phase 3: TEW-840APB0 Unit #2 Hardware Setup and Configuration

When configuring the TEW-840APB0 #2, repeat 1-14 of the steps in Phase 2 setup and configuration.

1. In Step 15, under IPv4 Settings, enter the IP Address **192.168.10.51** and Subnet Mask **255.255.255.0**, then click **Save** at the bottom of the page. When prompted to apply settings at the bottom right of the page, click **Apply** to commit the changes.

#### IPv4 Settings

IP Network Setting	<input type="radio"/> DHCP <input checked="" type="radio"/> Static IP
IP Address	<input type="text" value="192.168.10.51"/>
Subnet Mask	<input type="text" value="255.255.255.0"/>

Save

Save current setting(s)

Waiting for changes to be applied (2)

Apply

Apply

Revert

2. In the left hand menu under **Network**, click **Wireless**.

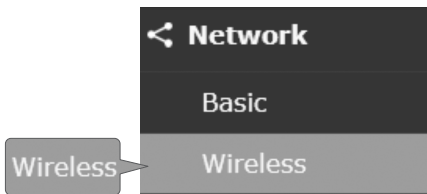

3. Under 5GHz-802.11 AC/N, click the **Operation Mode** drop-down list and select **WDS Station**.

	5GHz -802.11 AC/N
Operation Mode	<input type="text" value="WDS Station"/>

4. Under Wireless Settings – 5GHz, click **Edit**.

Wireless Settings - 5GHz

SSID	Edit	Security
<input type="text"/>	<b>Edit</b>	None

5. Under Wireless Setting – 5GHz, next to Preferred BSSID, click **Device Discovery**. The device will scan for wireless networks.

Wireless Setting - 5GHz

Preferred BSSID  **Device Discovery**

6. In the Site Survey list, select the SSID of the TEW-840APB0 #1.

**Note:** This is the SSID of TEW-840APB0 #1 from Phase 2 Step 2.

Site Survey

BSSID	SSID	Channel
XX:XX:XX:XX:XX:XX	TRENDnet840_XXXX	48
XX:XX:XX:XX:XX:XX	TRENDnet828_5GHz_0QNU	153
XX:XX:XX:XX:XX:XX	TRENDnet818_5GHz_N6QM	149

7. Under Wireless Security – 5GHz, in the **Password** field, enter the WPA2 key of TEW-840APB0 #1 and click **Save**.

**Note:** This is the WPA2 key of TEW-840APB0 #1 from Phase 2 Step 2.

Wireless Setting - 5GHz

Preferred BSSID  **Device Discovery**

SSID

---

Wireless Security - 5GHz

Security Mode

Encryption

Password

**Save** Save current setting(s)

8. After you are brought back to the main wireless settings page, click **Save** at the bottom of the page. When prompted to apply settings at the bottom right of the page, click **Apply** to commit the changes.

**Save** Save current setting(s)

Waiting for changes to be applied (6)

**Apply** **Apply** **Revert**

## Phase 4: Confirm Connectivity

1. Leave your computer connected to TEW-840APB0 #2 and keep the web management interface open. In the left hand menu under Overview, click **Connections** and the **Connection Status** should display **Associated**.
2. Make sure both TEW-840APB0 #1 and TEW-840APB0 #2 access points are powered on approximately 15 ft. (5 m) apart from one another with front of access points directly facing each other.

TEW-840APB0 #1

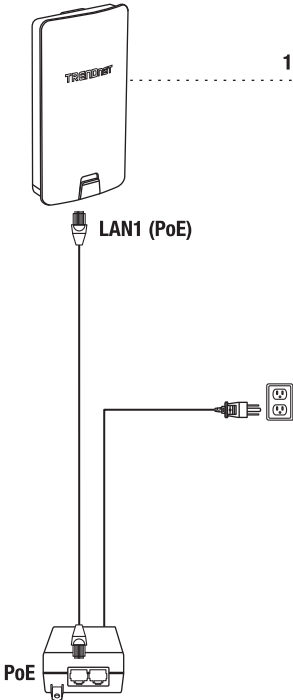

TEW-840APB0 #2

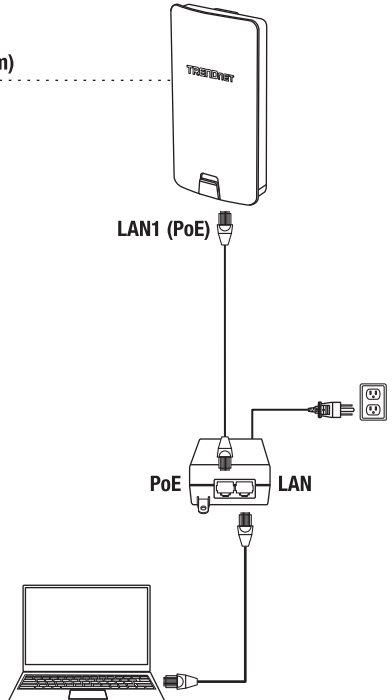

15 ft. (5m)

3. To further verify connectivity, in the TEW-840ABPO #2 web management interface under **Management**, click on **Tools**.

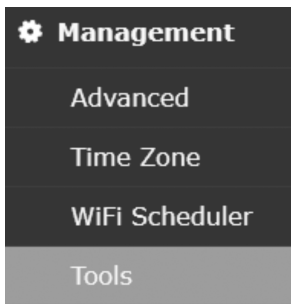

4. Under Ping in the **Target IP / Domain Name** field, enter the IP address of TEW-840APBO #1, **192.168.10.50**, then click **Start**.

#### Ping Test Parameters

Target IP / Domain Name	<input type="text" value="192.168.10.50"/>
Ping Packet Size	<input type="text" value="64"/> Bytes
Number of Pings	<input type="text" value="4"/>
<input type="button" value="Start"/>	<input type="button" value="Start"/>

5. Ping replies and 0% packet loss will indicate as successful point to point bridge connection between the TEW-840APBO #1 and #2.

```

PING 192.168.10.50 (192.168.10.50): 64 data bytes
72 bytes from 192.168.10.50: seq=0 ttl=64 time=3.908 ms
72 bytes from 192.168.10.50: seq=1 ttl=64 time=1.424 ms
72 bytes from 192.168.10.50: seq=2 ttl=64 time=2.123 ms
72 bytes from 192.168.10.50: seq=3 ttl=64 time=2.250 ms

--- 192.168.10.50 ping statistics ---
4 packets transmitted, 4 packets received, 0% packet loss
round-trip min/avg/max = 1.424/2.426/3.908 ms

```

**Note:** If the connectivity test fails, wait for about a minute and try again. Make sure there are no obstacles between the two access points when running the connectivity test and make sure the two access points are not too close together.

### 3. Hardware Installation

---

1. Reinstall the cover by lining up the guide into the notch as shown and push until the cover clips into place and is secured. The cover includes cable openings to route the connected Ethernet cable(s) when installing.

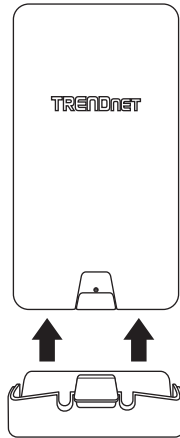

2. Loosen and open the pole mounting clamps using a flat head screwdriver or power drill turning the screw counter clockwise.

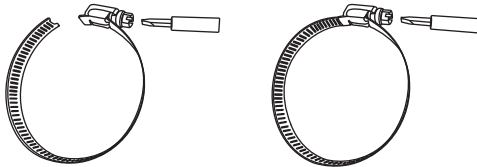

3. Insert the pole mounting clamps into the openings at the back of the access point.

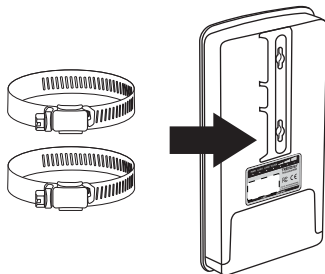

4. Wrap the fasteners around the pole where the access points will be installed. On the fasteners, insert the open end into the locking mechanism and pull tight until the access point is secured.

**Note:** When set to WDS station mode, the TEW-840APB0 features WiFi signal strength connectivity LEDs located on the back of the access point to assist in determining the optimal mounting position. (Red = Good, Orange = Better, Green = Best)

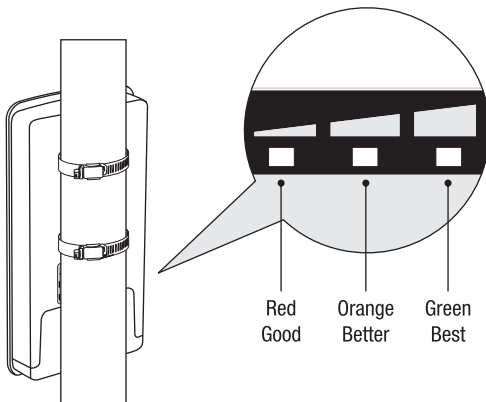

5. Secure the access point to the mounting location by turning the mounting clamp screw clockwise.

## Completed Installation Reference

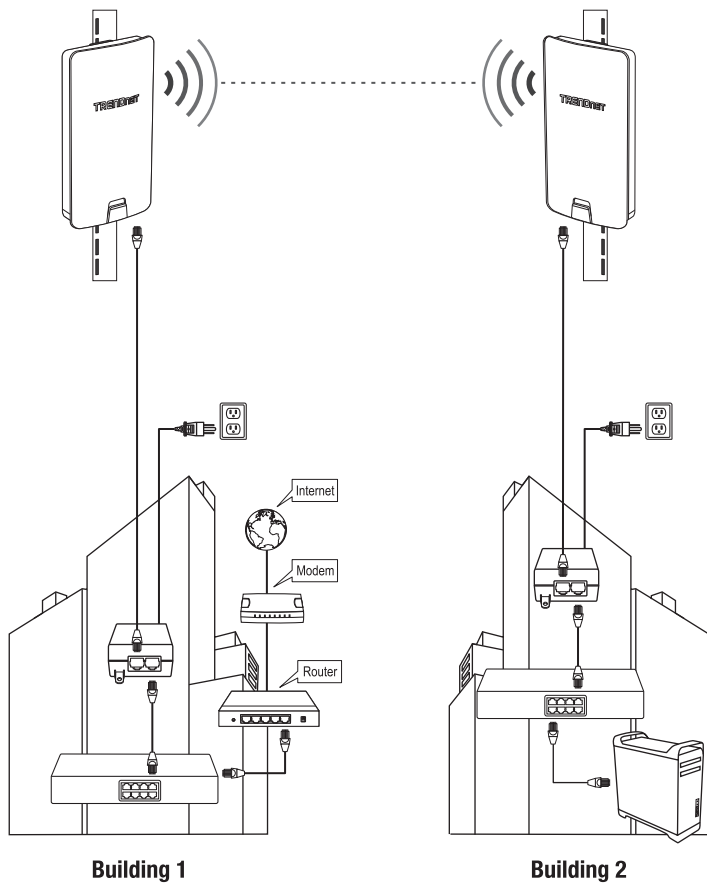



## **Federal Communication Commission Interference Statement**

This device complies with Part 15 of the FCC Rules. Operation is subject to the following two conditions:

(1) This device may not cause harmful interference, and (2) this device must accept any interference received, including interference that may cause undesired operation.

This equipment has been tested and found to comply with the limits for a Class B digital device, pursuant to Part 15 of the FCC Rules. These limits are designed to provide reasonable protection against harmful interference in a residential installation. This equipment generates, uses and can radiate radio frequency energy and, if not installed and used in accordance with the instructions, may cause harmful interference to radio communications. However, there is no guarantee that interference will not occur in a particular installation. If this equipment does cause harmful interference to radio or television reception, which can be determined by turning the equipment off and on, the user is encouraged to try to correct the interference by one of the following measures:

- Reorient or relocate the receiving antenna.
- Increase the separation between the equipment and receiver.
- Connect the equipment into an outlet on a circuit different from that to which the receiver is connected.
- Consult the dealer or an experienced radio/TV technician for help.

**FCC Caution:** Any changes or modifications not expressly approved by the party responsible for compliance could void the user's authority to operate this equipment.

This transmitter must not be co-located or operating in conjunction with any other antenna or transmitter.

### **Radiation Exposure Statement:**

This equipment complies with FCC radiation exposure limits set forth for an uncontrolled environment. This equipment should be installed and operated with minimum distance 25cm between the radiator & your body.

## Professional installation instruction

### 1. Installation personal

This product is designed for specific application and needs to be installed by a qualified personal who has RF and related rule knowledge. The general user shall not attempt to install or change the setting.

### 2. Installation location

The product shall be installed at a location where the radiating antenna can be kept 25cm from nearby person in normal operation condition to meet regulatory RF exposure requirement.

### 3. External antenna

Use only the antennas which have been approved by the applicant. The non-approved antenna(s) may produce unwanted spurious or excessive RF transmitting power which may lead to the violation of FCC limit and is prohibited.

### 4. Installation procedure

Please refer to user's manual for the detail.

### 5. Warning

Please carefully select the installation position and make sure that the final output power does not exceed the limit set force in relevant rules. The violation of the rule could lead to serious federal penalty.

No.	Type	Connector	Gain (dBi)			Remark
1	Patch	I-PEX	Ant. 1 (5150-5850MHz)		Ant. 2 (5150-5850MHz)	For Model: TEW-840APB0 and TEW-840APB02K use only
			13.35		13.42	
2	Dipole	RSMA	5150MHz	5550MHz	5850MHz	For Model: TEW-840APB0 use only
			5.12	5.09	5.17	
3	Patch	I-PEX	Ant. 1 (5150-5925MHz)		Ant. 2 (5150-5925MHz)	For Model: TEW-840APB0 and TEW-840APB02K use only
			15.5		15.5	

### **Industry Canada statement:**

This device complies with ISED's licence-exempt RSSs. Operation is subject to the following two conditions: (1) This device may not cause harmful interference, and (2) this device must accept any interference received, including interference that may cause undesired operation.

Le présent appareil est conforme aux CNR d'ISED applicables aux appareils radio exempts de licence. L'exploitation est autorisée aux deux conditions suivantes : (1) le dispositif ne doit pas produire de brouillage préjudiciable, et (2) ce dispositif doit accepter tout brouillage reçu, y compris un brouillage susceptible de provoquer un fonctionnement indésirable.

#### **Caution:**

- (i) the device for operation in the band 5150-5250 MHz is only for indoor use to reduce the potential for harmful interference to co-channel mobile satellite systems;
- (ii) for devices with detachable antenna(s), the maximum antenna gain permitted for devices in the band 5725-5850 MHz shall be such that the equipment still complies with the e.i.r.p. limits as appropriate;
- (iii) where applicable, antenna type(s), antenna models(s), and worst-case tilt angle(s) necessary to remain compliant with the e.i.r.p. elevation mask requirement set forth in section 6.2.2.3 shall be clearly indicated.

#### **Avertissement:**

- (i) les dispositifs fonctionnant dans la bande 5150-5250 MHz sont réservés uniquement pour une utilisation à l'intérieur afin de réduire les risques de brouillage préjudiciable aux systèmes de satellites mobiles utilisant les mêmes canaux;
- (ii) pour les dispositifs munis d'antennes amovibles, le gain maximal d'antenne permis (pour les dispositifs utilisant la bande de 5 725 à 5 850 MHz) doit être conforme à la limite de la p.i.r.e. spécifiée, selon le cas;
- (iii) lorsqu'il y a lieu, les types d'antennes (s'il y en a plusieurs), les numéros de modèle de l'antenne et les pires angles d'inclinaison nécessaires pour rester conforme à l'exigence de la p.i.r.e. applicable au masque d'élévation, énoncée à la section 6.2.2.3, doivent être clairement indiqués.

## **Radiation Exposure Statement:**

This equipment complies with ISED radiation exposure limits set forth for an uncontrolled environment. This equipment should be installed and operated with greater than 25cm between the radiator & your body.

## **Déclaration d'exposition aux radiations:**

Cet équipement est conforme aux limites d'exposition aux rayonnements ISED établies pour un environnement non contrôlé. Cet équipement doit être installé et utilisé à plus de 25cm entre le radiateur et votre corps.

## **Approved Antenna list**

<b>Type</b>	<b>Gain</b>	<b>Brand</b>	<b>Manufacturer</b>	<b>Note</b>
Patch Antenna	13.35	SENAO NETWORKS	SENAO NETWORKS	SENAO NETWORKS
Patch Antenna	13.42	SENAO NETWORKS	SENAO NETWORKS	SENAO NETWORKS

## **Professional installation instruction**

### **1. Installation personal**

This product is designed for specific application and needs to be installed by a qualified personal who has RF and related rule knowledge. The general user shall not attempt to install or change the setting.

### **2. Installation location**

The product shall be installed at a location where the radiating antenna can be kept 25cm from nearby person in normal operation condition to meet regulatory RF exposure requirement.

### **3. External antenna**

Use only the antennas which have been approved by the applicant. The non-approved antenna(s) may produce unwanted spurious or excessive RF transmitting power which may lead to the violation of FCC/IC limit and is prohibited.

### **4. Installation procedure**

Please refer to user's manual for the detail.

### **5. Warning**

Please carefully select the installation position and make sure that the final output power does not exceed the limit set force in relevant rules. The violation of the rule could lead to serious federal penalty.

## Certifications

This device complies with Part 15 of the FCC Rules.

Operation is subject to the following two conditions:

- (1) This device may not cause harmful interference.
- (2) This device must accept any interference received.

Including interference that may cause undesired operation.



Waste electrical and electronic products must not be disposed of with household waste. Please recycle where facilities exist. Check with your Local Authority or Retailer for recycling advice.

## Technical Support

If you have any questions regarding the product installation, please contact our Technical Support.

Toll free US/Canada: **1-855-373-4741**

Regional phone numbers available

at [www.trendnet.com/support](http://www.trendnet.com/support)

## TRENDnet

20675 Manhattan Place

Torrance, CA 90501

USA

Applies to PoE Products Only: This product is to be connected only to PoE networks without routing to the outside plant.

## Note

The Manufacturer is not responsible for any radio or TV interference caused by unauthorized modifications to this equipment. Such modifications could void the user's authority to operate the equipment.

## Advertencia

En todos nuestros equipos se mencionan claramente las características del adaptador de alimentación necesario para su funcionamiento. El uso de un adaptador distinto al mencionado puede producir daños físicos y/o daños al equipo conectado. El adaptador de alimentación debe operar con voltaje y frecuencia de la energía eléctrica domiciliar existente en el país o zona de instalación.

## Product Warranty Registration

Please take a moment to register your product online. Go to TRENDnet's website at [www.trendnet.com/register](http://www.trendnet.com/register)