

User's Guide

**TRENDNET<sup>®</sup>**



**10 dBi Wireless N300 Outdoor PoE Access Point**

**TEW-740APBO**

## Contents

<b>Product Overview .....</b>	<b>1</b>
Package Contents .....	1
Features .....	1
Product Hardware Features.....	2
Application Diagram .....	4
<b>Primary Product Application .....</b>	<b>5</b>
<b>Minimum Installation Requirements .....</b>	<b>5</b>
<b>Model Differences.....</b>	<b>6</b>
TEW-740APBO .....	6
TEW-740APBO2K .....	6
<b>TEW-740APBO Setup &amp; Installation .....</b>	<b>7</b>
Note the WiFi MAC Addresses.....	7
TEW-740APBO #1 .....	8
TEW-740APBO #2 .....	13
Confirm Connectivity .....	14
Ground Wire and Pole Mount Installation .....	15
Completed Installation Reference .....	16
<b>TEW-740APBO2K Setup and Installation .....</b>	<b>17</b>
Setup and Confirm Connectivity .....	18
Ground Wire and Pole Mount Installation .....	21
Completed Installation Reference .....	22
<b>Wireless Installation Tips.....</b>	<b>23</b>
<b>Application Modes .....</b>	<b>24</b>
AP Mode (Access Point Mode) .....	24
WDS Mode (Pure WDS) .....	25

Client Bridge + AP Mode.....	26
WISP (CPE) + AP Mode .....	26
Router Mode .....	27
CAP (Control AP) Mode .....	27
<b>Access your access point management page.....</b>	<b>28</b>
<b>AP Management Settings .....</b>	<b>29</b>
Management Setup .....	29
Set the device date and time.....	30
SNMP Settings .....	31
SNMP v2c.....	31
SNMP v3 .....	32
SNMP Trap .....	32
Backup and restore your AP configuration settings .....	33
Backup configuration settings .....	33
Restore configuration settings .....	33
Reset your AP to factory defaults.....	33
Soft reboot your AP .....	33
Upgrade your AP firmware .....	34
Network Utilities.....	34
View system information.....	35
View currently connected wireless client devices .....	36
View currently connected authenticated users .....	36
View authentication log information .....	36
View the device system log information .....	36
<b>Configuring additional application modes .....</b>	<b>37</b>
Access Point (AP) Mode.....	37
Set the device to AP mode .....	37
Set the device LAN IP address .....	37

Configure primary wireless network settings .....	38	IP Filter .....	63
MAC Address Filter .....	39	MAC Filter .....	63
DHCP Server .....	40	Virtual Server .....	64
DHCP Reservation/Static Lease .....	41	Access Control .....	64
802.11r/802.11k Fast Roaming .....	42	Time Policy / Schedule .....	65
Additional Wireless Settings .....	43	Router Mode .....	67
Advanced Wireless Settings .....	45	Set the device LAN IP address settings .....	67
Wireless WMM QoS Setup .....	46	Configure the LAN DHCP Server .....	67
WDS (Wireless Distribution System) .....	48	DHCP Reservation/Static Lease .....	69
Authentication/Captive Portal .....	50	Configure WAN connection settings .....	69
Guest Authentication .....	51	DMZ (Demilitarized Zone) .....	70
OAuthentication 2.0 .....	52	IP Filter .....	71
POP3 Server .....	53	MAC Filter .....	71
Customize Page .....	54	Virtual Server .....	72
Multiple Language .....	55	Access Control .....	72
Walled Garden .....	55	Time Policy / Schedule .....	73
Privilege Address .....	56	CAP (Control AP) Mode .....	75
Backup/Restore Authentication Profile & Customized Pages .....	56	Scan and Import CAP Mode compatible APs .....	76
Client Bridge + AP Mode .....	57	Modify and view your managed AP list .....	77
Set the device to Client Bridge + AP mode .....	57	Batch Configuration Settings .....	77
Set the device IP address settings .....	57	Group Setup .....	78
Connect the device to your wireless network .....	58	Map Setup .....	78
Configure your wireless network settings (WLAN) .....	58	Authentication Profile .....	79
WISP (CPE) + AP Mode .....	59	Managed AP Status .....	79
Set the device LAN IP address settings .....	59	<b>Technical Specifications .....</b>	<b>80</b>
Configure the LAN DHCP Server .....	59	<b>Appendix .....</b>	<b>82</b>
DHCP Reservation/Static Lease .....	60		
Configure WAN connection settings for WISP .....	61		
Connect to your WISP (Wireless Internet Service Provider) .....	61		
DMZ (Demilitarized Zone) .....	62		

## Product Overview



**TEW-740APBO**



**TEW-740APBO2K**

### Package Contents

**TEW-740APBO** package includes:

- 1 x TEW-740APBO
- CD-ROM (User's Guide)
- Quick Installation Guide
- Proprietary PoE injector
- Power adapter (12V DC, 1A)
- Mounting hardware
- Grounding wire

**TEW-740APBO2K** package includes:

- 2 x TEW-740APBO (Preconfigured WDS Bridge)
- CD-ROM (User's Guide)
- Quick Installation Guide
- Proprietary PoE injectors
- Power adapters (12V DC, 1A)
- Mounting hardware
- Grounding wires

### Features

TRENDnet's 10 dBi Outdoor PoE Access Point, model TEW-740APBO, provides wireless N300 point-to-point connectivity. A variety of installation scenarios are facilitated with Access Point (AP), Wireless Distribution System (WDS), Client Bridge + AP, Wireless ISP (WISP) + AP, CPE + AP, and control AP (CAP) modes. The IPX6 rated housing comes with wall and pole mounting hardware.

### Wireless Modes

Supports Access Point (AP), Wireless Distribution System (WDS), Client Bridge + AP, Wireless ISP (CPE) + AP, Router, and control AP (CAP) modes

### Wireless N300 (2.4 GHz)

Compliant with 802.11b/g/n technology (2.4 GHz) with data rates up to 300 Mbps\*

### Outdoor Rated

Durable enclosure with an IPX6 outdoor weather rating

### Directional Antenna

Built in 10 dBi directional antenna

### PoE Power Adapter

Proprietary PoE power adapter included

### Logs

Real time logs and statistics help troubleshooting

### Encrypted Wireless

Support for wireless encryption of up to WPA2

### Multiple SSIDs

Create up to eight additional SSIDs

### Compatibility

Compatible with legacy wireless devices

### Mounting Hardware

Pole and wall mount hardware included

\* Effective wireless coverage may vary depending on the wireless device's output power, antenna gain, antenna alignment, receiving sensitivity, and radio interference. Additionally environmental factors such as weather conditions, physical obstacles, and other considerations may affect performance. For optimal results, we recommended consulting a professional installer for site survey, safety precautions, and proper installation.

### Product Hardware Features

Front View



IPX6 Weather Rated Housing with built-in directional sector antenna

Bottom View (Closed)

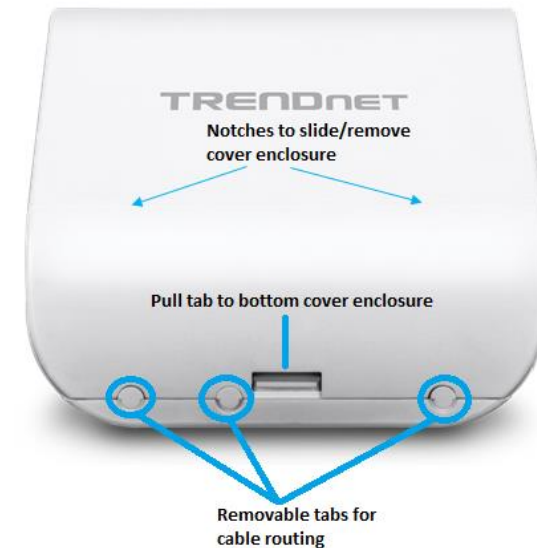

## Bottom View (Open)

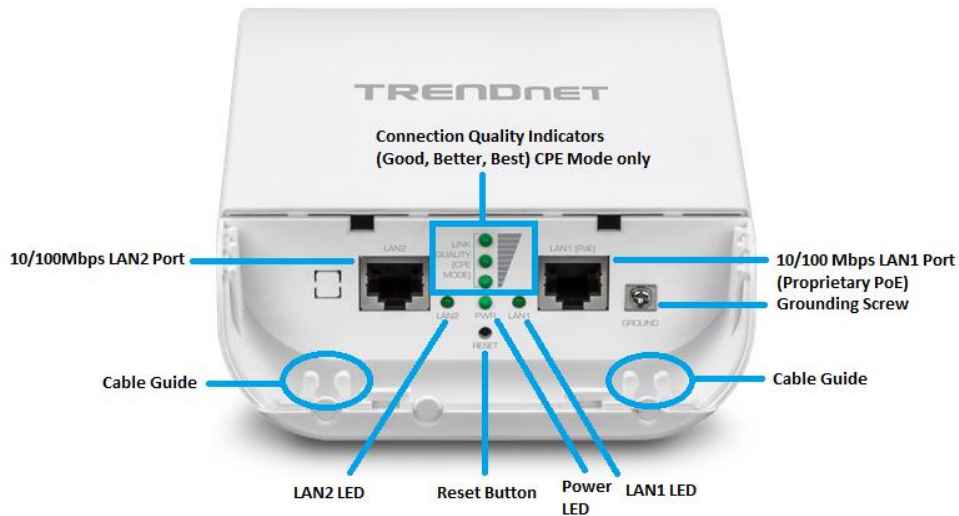

- **LAN1 (PoE) Port** – This Ethernet interface will be used to power the access point through the P+DATA OUT proprietary PoE injector and provide 10/100Mbps network connectivity to the access point. **Router mode only:** The LAN1 port interface will be used for wired WAN Internet connectivity when the access point is configured in Router mode and wired LAN connectivity can be used on the LAN2 port interface.
- **LAN2 Port** – This Ethernet interface is a secondary 10/100Mbps LAN port interface and can be used to also access the access point. The LAN2 port and LAN1 (PoE) port are bridged for all modes except Router mode where LAN2 will function as a wired LAN port and LAN1 port will function as wired WAN Internet port.
- **LAN1 LED** – When the LED is on, this indicates an active network connection to the LAN1 port. If there is no active network connection to 10/100 DATA IN on the proprietary PoE injector, there is no active link to the LAN1 port and LED will be off. When the LED is blinking, this indicates data is being transmitted or received on the LAN1 port.
- **LAN2 LED** - When the LED is on, this indicates an active network connection to the LAN2 port. If the LED is off, there is no active network connection to the

LAN2 port. When the LED is blinking, this indicates data is being transmitted or received on the LAN2 port.

- **Power (PWR) LED** – When the LED is on, this will indicate that the device is receiving power and off if the device is not receiving power.
- **Reset Button** – The reset button resets the access point to factory default settings. Using a paper clip, push and hold the reset button for 15 sec. and release. The LEDs will flash when the device reset has been initiated.
- **Connection Quality Indicators** – These LEDs will indicate the wireless connection quality to the wireless ISP network when using WISP (CPE) mode.
- **Grounding Screw** – The grounding point/screw allows you to attach the unit to a proper ground point.
- **Cable Guides/Removable tabs** – With the enclosure cover installed, the cable guides and removable tabs allows you to route RJ-45 cables and the ground cable externally from the device while protecting the internal port connection of the device to the network.

**Important Note:**

It is recommended to use RJ-45 cables without any additional caps, molded caps, or boots specifically on the connector side that will be connected to the access point LAN1 (PoE) port to avoid any cable fitment issues inside the access point enclosure.

- **Proprietary PoE Injector –**

- **Important Note:**

- The access point does not support standard IEEE 802.3at/af PoE/PoE+. Only the included proprietary PoE injector may be used to supply power to the access point.
    - For safety, use only the included PoE injector to supply power to the access point.

- **POWER IN** – Connect the included power adapter connector to this input and adapter side into an AC power source to supply power to the injector.
    - **P+DATA OUT** – Connect an Ethernet RJ-45 cable to this output and the other side to the device LAN1 (PoE) port to supply power to the device. Please note that the RJ-45 Ethernet cable between the proprietary PoE injector and the LAN1 (PoE) port of the access points supports a maximum length of up to 60 m (197 ft.). RJ-45 Ethernet cables longer than the maximum length specified may result in insufficient power to the device, intermittent connectivity/power loss, and unstable physical link.
    - **10/100 DATA IN** – Connect an Ethernet RJ-45 cable to this input and connect the other to your network or directly to a computer for initial device setup.

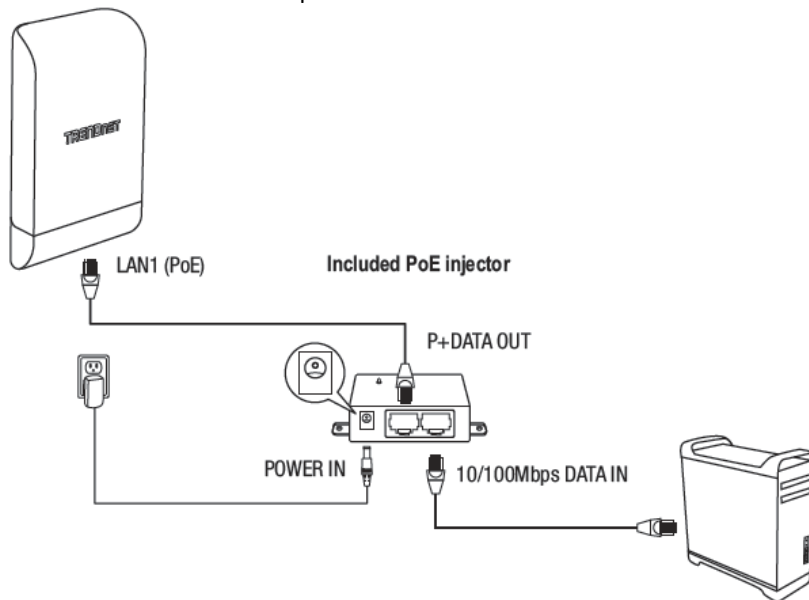

## Application Diagram

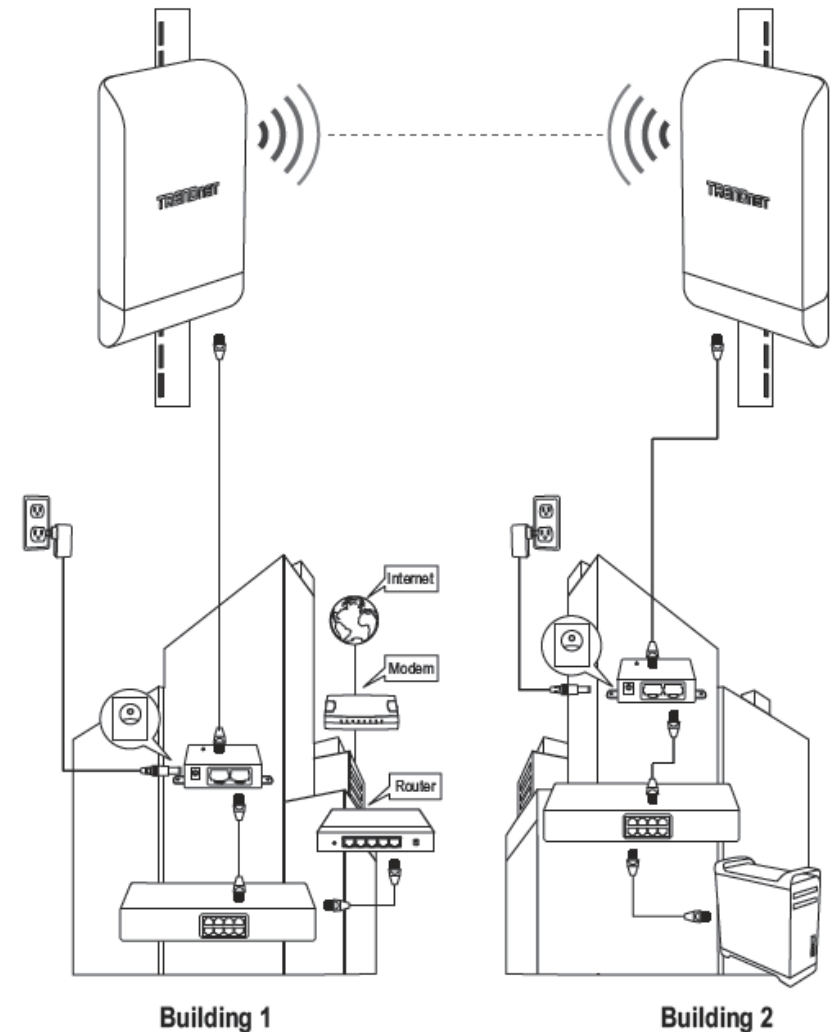

The example application displays two TEW-740APBO access points are configured in WDS point-to-point bridge mode and establishing a wireless link between each and other, allowing for network connectivity between two buildings over a point-to-point wireless link.

## Primary Product Application

The intended purpose and application for this product is to extend network connectivity across long physical distances outside of an area or building that lacks local connectivity using point-to-point wireless bridge capability using 802.11 standards. Essentially, two access points configured in point-to-point bridge capability can connect/link the two physical locations or buildings together through an encryption wireless connection. Although this product supports multiple wireless modes, the basic installation will only cover the primary application of point to point wireless connectivity in WDS (Wireless Distribution System) Bridge Mode using AES encryption for security.



## Minimum Installation Requirements

- Computer with RJ-45 Ethernet port and web browser
- 4 x RJ-45 Ethernet cables (not included)
- Phillips screwdriver (not included, for grounding wire installation only)
- Additional TRENDnet TEW-740APBO H/W: v2.XR N300 directional wireless access point (For TEW-740APBO single unit only, TEW-740APBO2K model includes two preconfigured access points)

For wall mounting only (included wall mounting kit for drywall installations only)

- Power drill/driver
- 7/16 in (2.75 mm) straight drill bit for hard wood or 3/32 in (2.35 mm) bit for soft wood (for mounting screws)
- 11/16 in (4.3 mm) straight drill bit for hard wood or 5/32 in (4 mm) bit for soft wood (if required for drywall anchors)
- Philips driver bit or screwdriver



## Model Differences

### TEW-740APBO

#### Single Unit Model

The single access point requires another TEW-740APBO H/W: v2.XR N300 additional access point to create a WDS point-to-point wireless link.

#### Important Note:

Purchasing this model requires the access points to be properly configured to establish the wireless link/bridged connection to each other and verifying connectivity first before mounting the access points in their desired locations.

#### Single Unit Default Settings

LAN IP Address: 192.168.10.100  
 LAN Subnet Mask: 255.255.255.0  
 Mode: Access Point (AP) Mode  
 User: admin  
 Password: admin

### TEW-740APBO2K

#### Preconfigured Bridge Kit Model

The two access points in the kit model are preconfigured to establish a WDS bridged connection to each using a unique AES encryption key. For convenience, a unique predefined administrator password is also assigned. The predefined AES encryption key and administrator password can be found on the included wireless settings sticker or on the device label.

#### Important Note:

Purchasing this model does not require any additional configuration to establish the wireless link/bridged connection between the two access points but it is strongly recommended that you verify connectivity first between the two access points first before mounting them in their desired locations.

#### Preconfigured Kit Default Settings

TEW-740APBO #1  
 LAN IP Address: 192.168.10.50  
 LAN Subnet Mask: 255.255.255.0  
 Mode: WDS Bridge Mode  
 WDS AES Encryption Key: <predefined>  
 User: admin  
 Password: <predefined>

TEW-740APBO #2  
 LAN IP Address: 192.168.10.51  
 LAN Subnet Mask: 255.255.255.0  
 Mode: WDS Bridge Mode  
 WDS AES Encryption Key: <predefined>  
 User: admin  
 Password: <predefined>

## Unit 1

## Unit 2

<b>Preset Wireless Settings</b>	
Mode/WiFi Channel	WDS Bridge/CH 1
AES Encryption Key	740XXXXXXXX
Management Login	
http://192.168.10.50	
username: admin	
password: XXXXXXXX	

<b>Preset Wireless Settings</b>	
Mode/WiFi Channel	WDS Bridge/CH 1
AES Encryption Key	740XXXXXXXX
Management Login	
http://192.168.10.51	
username: admin	
password: XXXXXXXX	

## TEW-740APBO Setup & Installation

The following installation procedure assumes you are setting up and installing two TRENDnet TEW-740APBO H/W: v2.XR access points in WDS bridge point-to-point configuration.

### Note the WiFi MAC Addresses

1. Remove the cover of the access points by pulling and holding the tab in the vertical direction upward (as shown in the picture below) and sliding the cover in the two locations noted away from the access point.

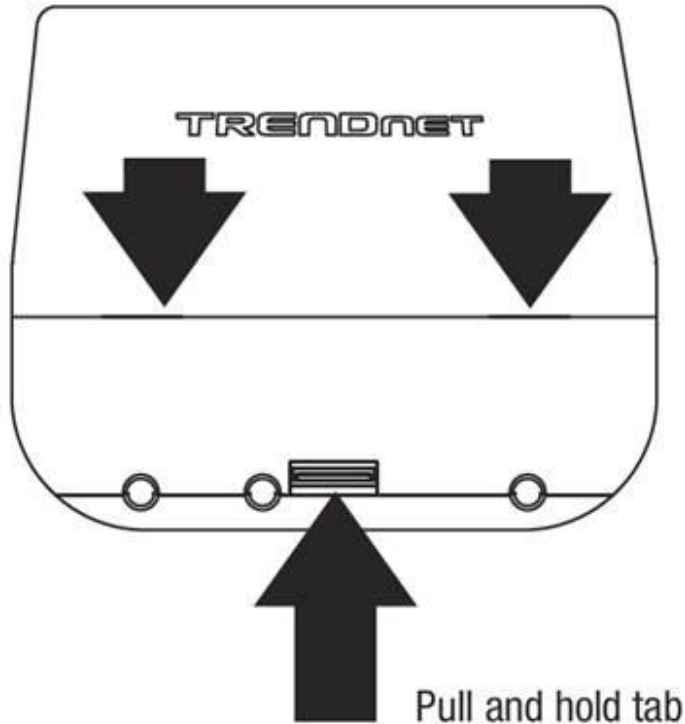

2. On the device label located inside, write down the WiFi MAC of each access point.

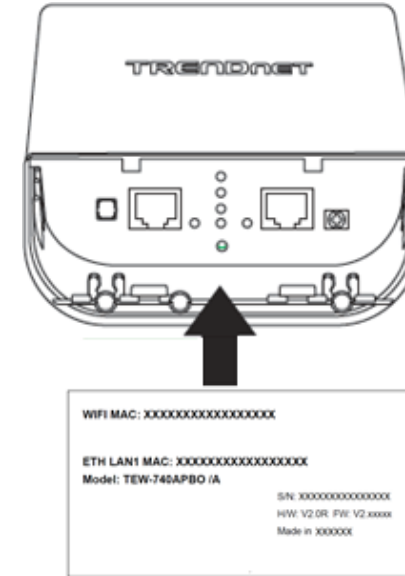

**Note:** In this installation procedure example, we will assume the WiFi MAC addresses:

	TEW-740APBO #1	TEW-740APBO #2
WiFi MAC Address	00:11:22:33:44:00	00:11:22:33:44:11

Router Settings:

Router/Default Gateway IP Address: 192.168.10.1

Subnet Mask: 255.255.255.0

In this installation procedure example, we will configure the TEW-740APBO access points will be configured with the following settings:

	TEW-740APBO #1	TEW-740APBO #2
IP Address	192.168.10.50	192.168.10.51
Netmask (Subnet Mask)	255.255.255.0	255.255.255.0
IP Gateway (Default Gateway)	192.168.10.1	192.168.10.1
Primary DNS	192.168.10.1	192.168.10.1
Wireless Channel (Default)	1	1
Mode	WDS	WDS
WDS Encryption	AES	AES

**TEW-740APBO #1**

1. Remove the tab on the far left by gently bending it back and forth until the tab is removed. This will create the opening the RJ-45 network cable to be routed through.

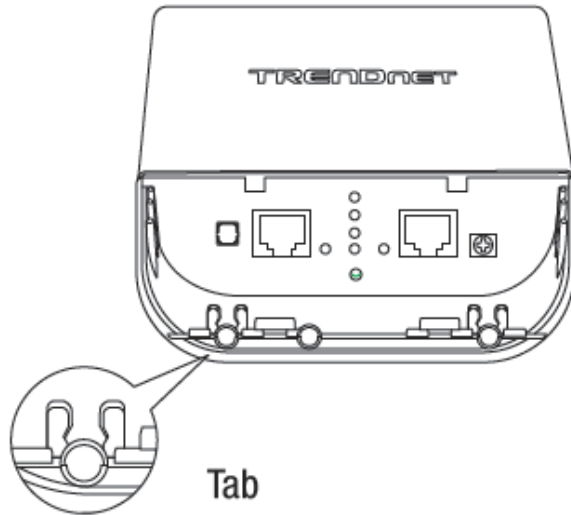

2. Using a RJ-45 network cable, connect one end of the cable to the LAN (PoE) port and push the cable into the guide on the far left, then through the opening that was created in the previous step.

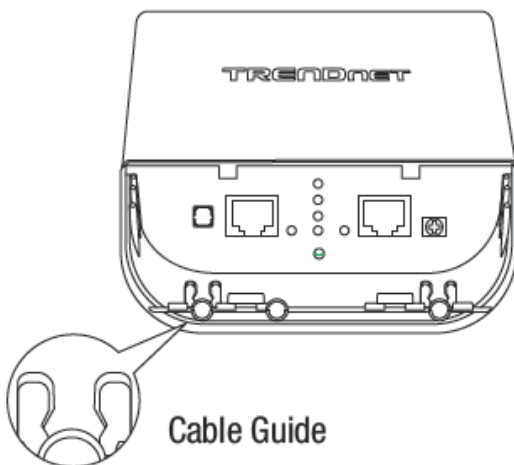

3. Connect the other end of the RJ-45 network cable to the **P+DATA OUT** port on the included PoE injector.
4. Using another RJ-45 network cable, connect one end of the **10/100 DATA IN** port on the included PoE injector.
5. Connect the other end of the RJ-45 network cable to your computer's Ethernet port.
6. Connect the included power adapter to the PoE injector **POWER IN** on the included PoE injector.
7. Plug the connected power adapter into a power outlet.
8. Confirm the device is powered on through the **PWR** LED indicator.

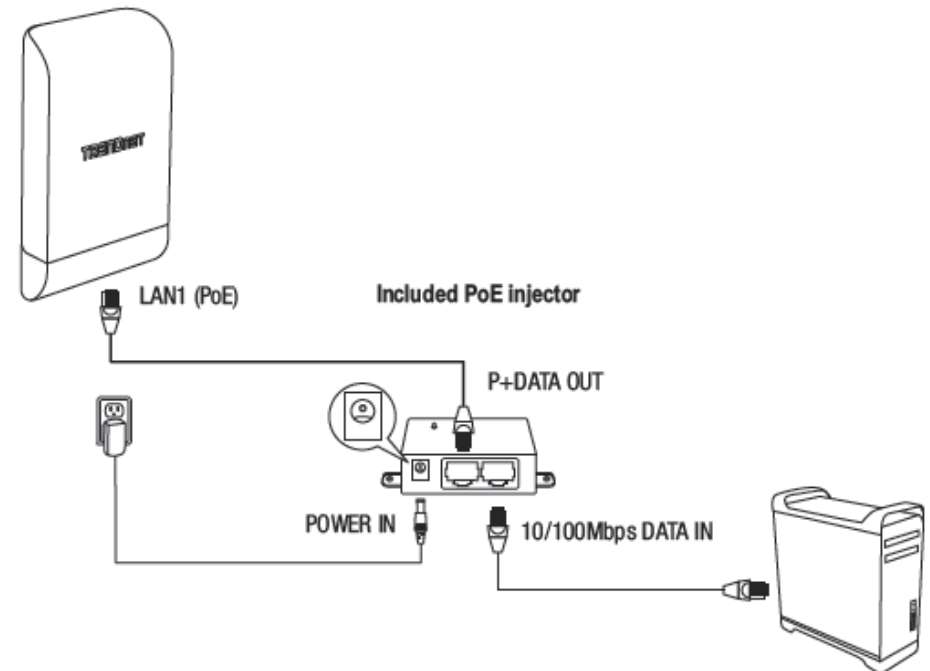

9. Assign a static IP address to your computer's network adapter in the subnet of 192.168.10.x (e.g. 192.168.10.10) and subnet mask of 255.255.255.0.

**Note:** For information on how to statically assign your IP address, see the Appendix section.

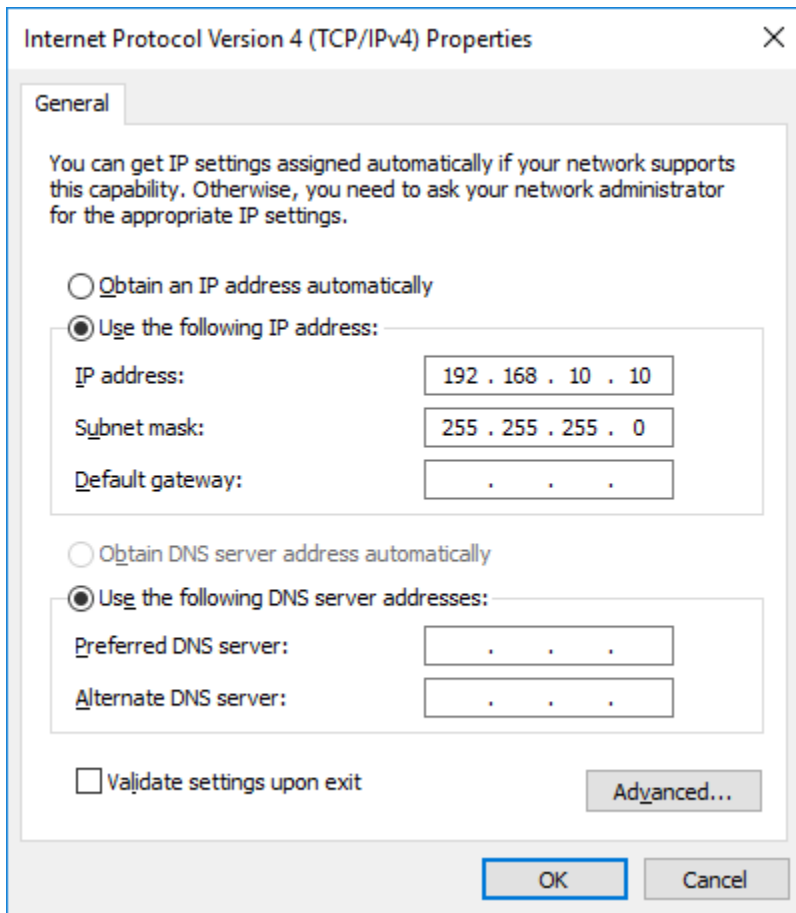

Internet Protocol Version 4 (TCP/IPv4) Properties

General

You can get IP settings assigned automatically if your network supports this capability. Otherwise, you need to ask your network administrator for the appropriate IP settings.

Obtain an IP address automatically

Use the following IP address:

IP address: 192 . 168 . 10 . 10

Subnet mask: 255 . 255 . 255 . 0

Default gateway: . . .

Obtain DNS server address automatically

Use the following DNS server addresses:

Preferred DNS server: . . .

Alternate DNS server: . . .

Validate settings upon exit

Advanced...

OK Cancel

10. Open your web browser and type in the default IP address of the access point in the address bar, then press **Enter**. The default IP address is 192.168.10.100.



11. When prompted, login to the access point management page using the default user name and password settings.

User Name: admin

Password: admin

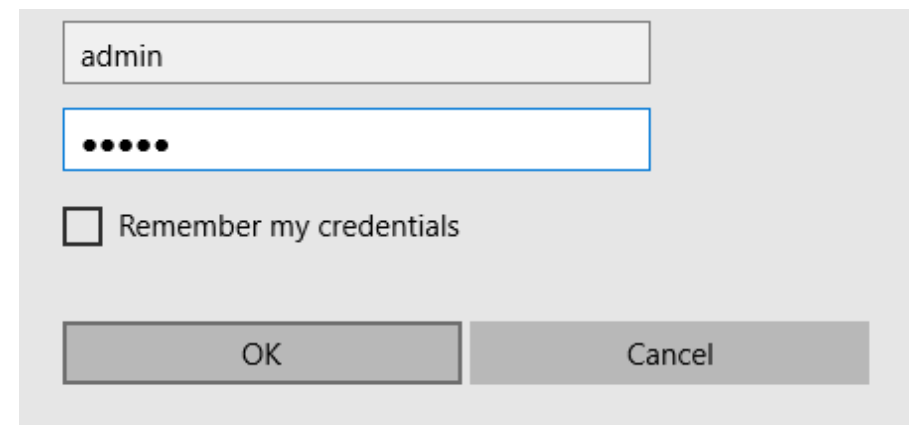

admin

.....

Remember my credentials

OK Cancel

12. Click on the **System** tab and select **Management**.

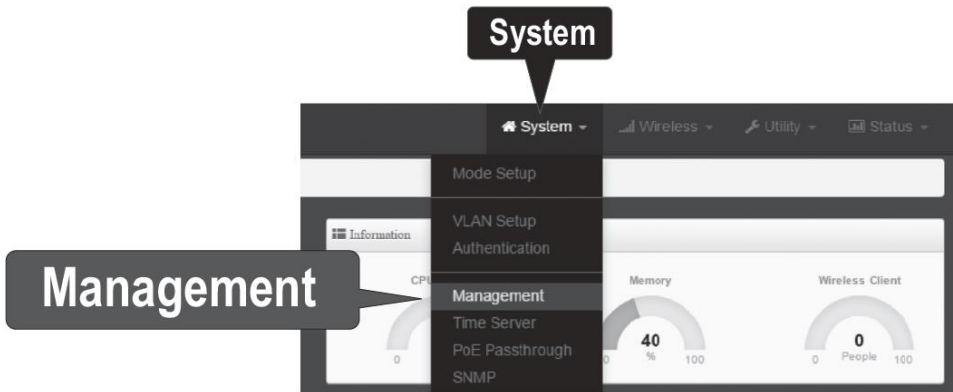

13. Under **Administrator Password**, change the default administrator password by typing in the new password in the fields provided and then click the **Save** button at the bottom of the page.

Administrator Password

New Admin Password

Check Admin Password

14. Click on the **System** tab and click on **Mode Setup**.

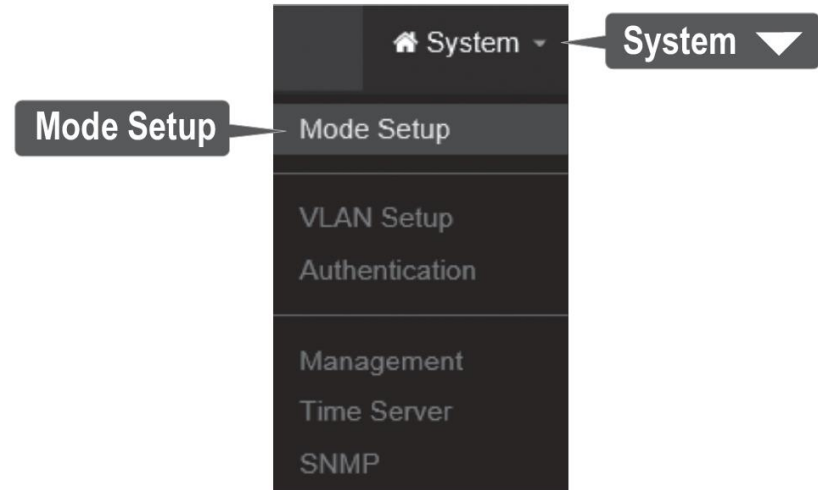

15. Click on the **Mode** field and in the drop-down list click on **WDS Mode**, then click on **Save & Reboot**. When prompted to change the mode, click **Yes** and wait for the device to apply changes and reboot.

**Note:** After the device reboots, you may need to login to the management page again.

System Mode

Mode

- CAP Mode
- Access Point(AP) Mode
- WDS Mode
- ClientBridge + AP Mode
- WISP (CPE) + AP Mode
- Router Mode

Save & Reboot

Yes

System is restarting, please wait for 59 Seconds

16. After device saves changed and reboots, click on **System** and click on **VLAN Setup**.

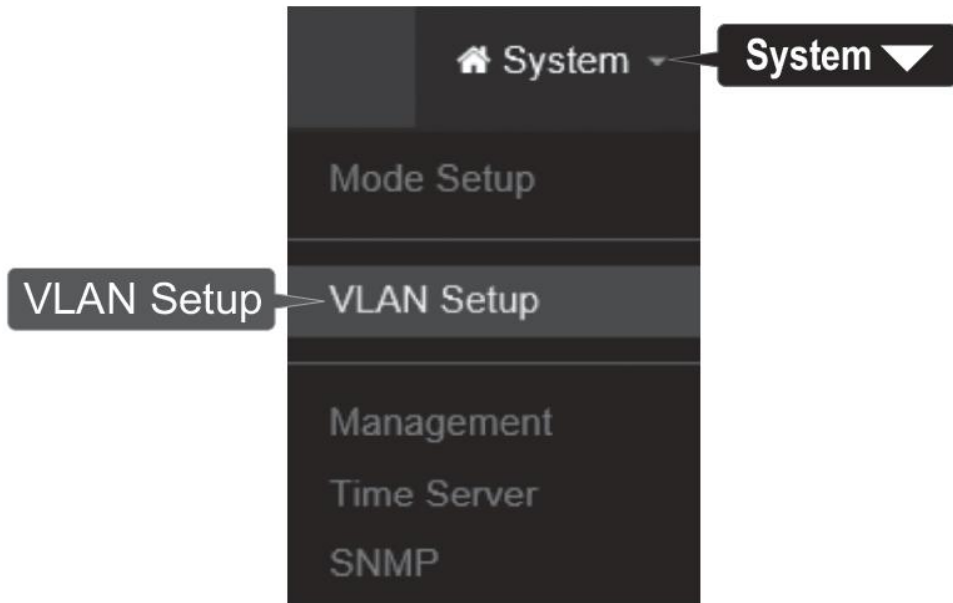

17. For the first entry in the VLAN List under the action column, click **Network**.

#	VLAN Mode	Flag	IP Address	Netmask	Action
0	On	Native ETH0 Native ETH1 Access Control	192.168.10.100	255.255.255.0	Network
1	Off	ETH0.101 ETH1.101	-	-	Network
2	Off	ETH0.102 ETH1.102	-	-	Network

18. In the IP Setup section, enter the IP Address **192.168.10.50**, then click **Save**. In the menu located at the top, you will be prompted to reboot the device. Click the **Reboot** button and in the following page, click **Reboot**. When prompted to reboot, click **Yes** apply changes and reboot.

**Note:** After the device reboots, you will need to reconnect to the access point configuration page using the new IP address setting and login. When configuring TEW-740APBO #2, enter the IP address 192.168.10.51.

A screenshot of the IP Setup configuration page. It shows the following fields: IP Mode (radio buttons for Enable and Disable, with 'Enable' selected), IP Address (text box containing '192.168.10.50'), and Netmask (text box containing '255.255.255.0').

Save

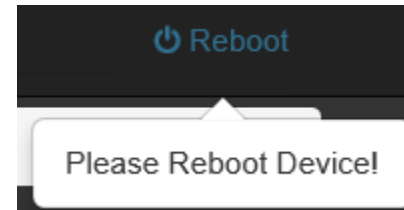

Reboot

Yes

System is restarting, please wait for 59 Seconds

19. Click on **Wireless** and click **WDS Setup**.

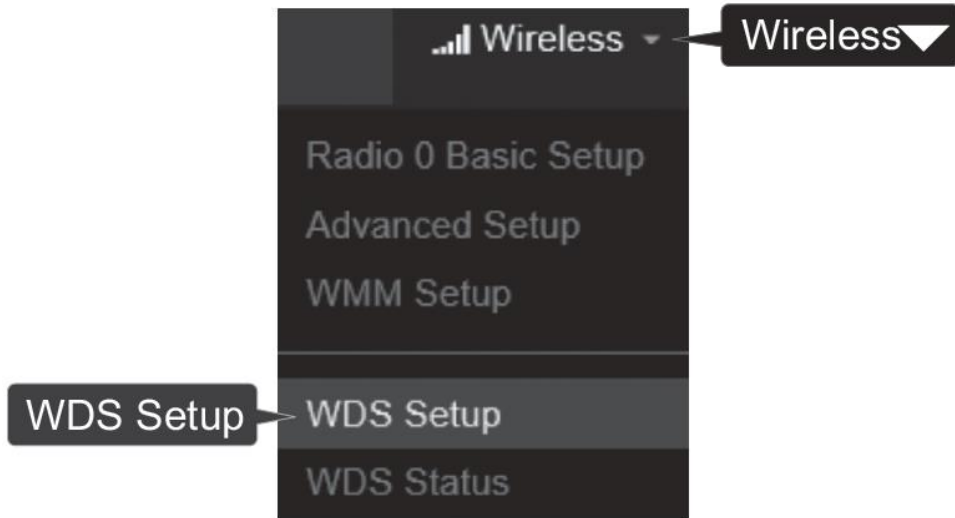

20. Click **Enabled** for the WDS Setup and under Authentication, select **AES**. Enter a WDS **Passphrase**. (8-63 alphanumeric characters)

**Note:** When configuring TEW-740APBO #2, the WDS passphrase must be the same passphrase configured on TEW-740APBO #1.

A screenshot of the 'WDS Setup' configuration page. It shows the following settings:

- WDS Setup:**  Enable  Disable
- ESSID:** TRENDnet\_740\_wds
- Authentication:** AES (selected from a dropdown menu)
- PassPhrase:** XXXXXXXX

21. Under WDS Client Setup, check the first entry and enter the WiFi MAC address of TEW-740APBO #2 **00:11:22:33:44:11**. Then click **Save**. In the menu located at the top, you will be prompted to reboot the device. Click the **Reboot** button and in the following page, click **Reboot**. When prompted to reboot, click **Yes** apply changes and reboot.

**Note:** When configuring TEW-740APBO #2, enter the WiFi MAC address of TEW-740APBO #1.

A screenshot of the 'WDS Client Setup' table. The table has two columns: 'Enable' and 'MAC Address'.

Enable	MAC Address
<input checked="" type="checkbox"/>	<input type="text" value="00:11:22:33:44:11"/>

**Save**

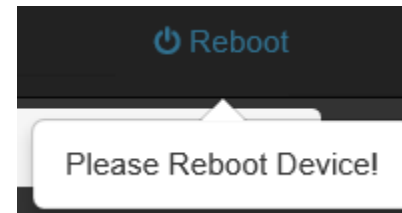

**Reboot**

**Yes**

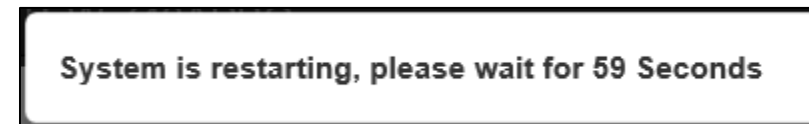

**TEW-740APBO #2**

When configuring TEW-740APBO #2, repeat all steps in previous section same as TEW-740APBO #1 and make sure to follow the noted differences below for steps 18, 20-21.

18. In the IP Setup section, enter the IP Address **192.168.10.51**, then click **Save**. In the menu located at the top, you will be prompted to reboot the device. Click the **Reboot** button and in the following page, click **Reboot**. When prompted to reboot, click **Yes** apply changes and reboot.

**Note:** After the device reboots, you will need to reconnect to the access point configuration page using the new IP address setting and login.

IP Setup	
IP Mode	<input checked="" type="radio"/> Enable <input type="radio"/> Disable
IP Address	<input type="text" value="192.168.10.51"/>
Netmask	<input type="text" value="255.255.255.0"/>

20. Click **Enabled** for the WDS Setup and under Authentication, select **AES**. Enter a WDS **Passphrase**. (8-63 alphanumeric characters)

**Note:** When configuring TEW-740APBO #2, the WDS passphrase must be the same passphrase configured on TEW-740APBO #1.

WDS Setup	
WDS Setup	<input checked="" type="radio"/> Enable <input type="radio"/> Disable
ESSID	<input type="text" value="TRENDnet_740_wds"/>
Authentication	<input type="text" value="AES"/> <input checked="" type="checkbox"/>
PassPhrase	<input type="text" value="XXXXXXXX"/>

21. Under WDS Client Setup, check the first entry and enter the WiFi MAC address of TEW-740APBO #1 **00:11:22:33:44:00**. Then click **Save**. In the menu located at the top, you will be prompted to reboot the device. Click the **Reboot** button and in the following page, click **Reboot**. When prompted to reboot, click **Yes** apply changes and reboot.

WDS Client Setup	
Enable	MAC Address
<input checked="" type="checkbox"/>	<input type="text" value="00:11:22:33:44:00"/>



### Confirm Connectivity

1. Leave your computer connected to TEW-740APBO #2 and keep the access point management page open.
2. Make sure both TEW-740APBO #1 and TEW-740APBO #2 access point are powered on and approximately 15 ft. (5 m) apart from one another with the front of access points directly facing each other.

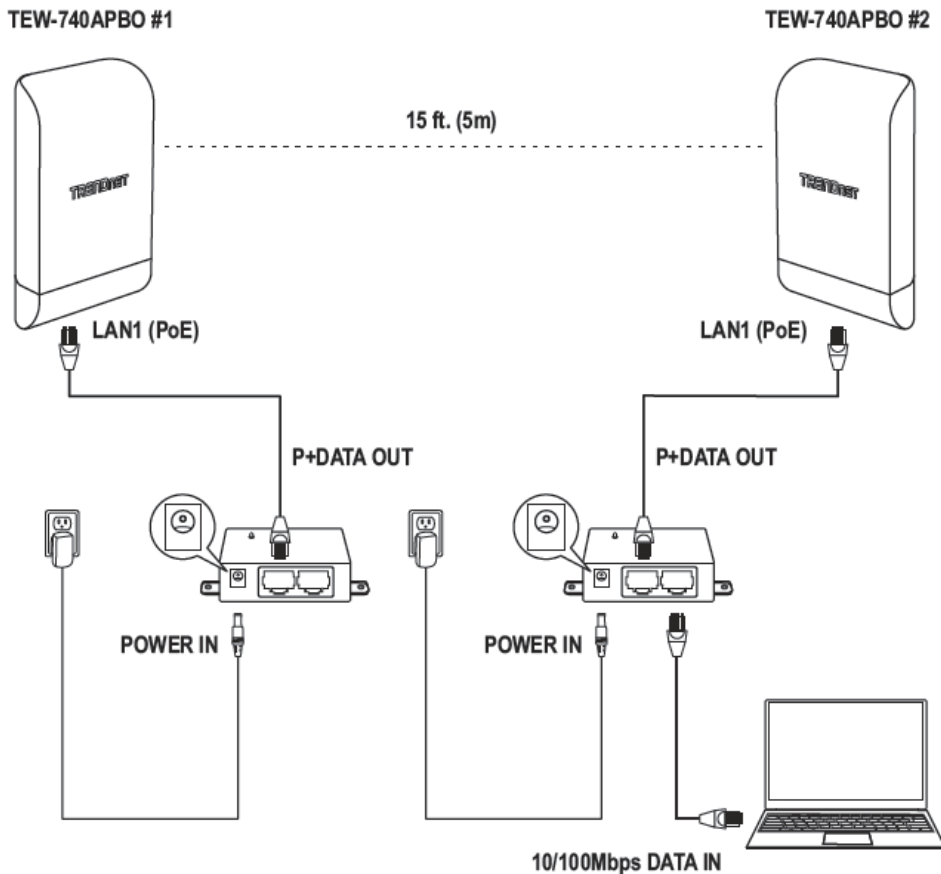

3. To verify connectivity, in the TEW-740APBO #2 access point management page, click on **Utility** and click on **Network Utility**.

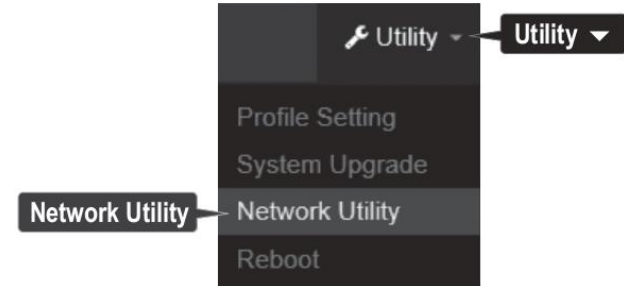

4. In the **IP/Domain** field, enter the IP address **192.168.10.50**. Next to Times, click **Ping**. Ping replies and 0% packet loss will indicate a successful WDS point to point bridge has been established between the two access points as shown below.

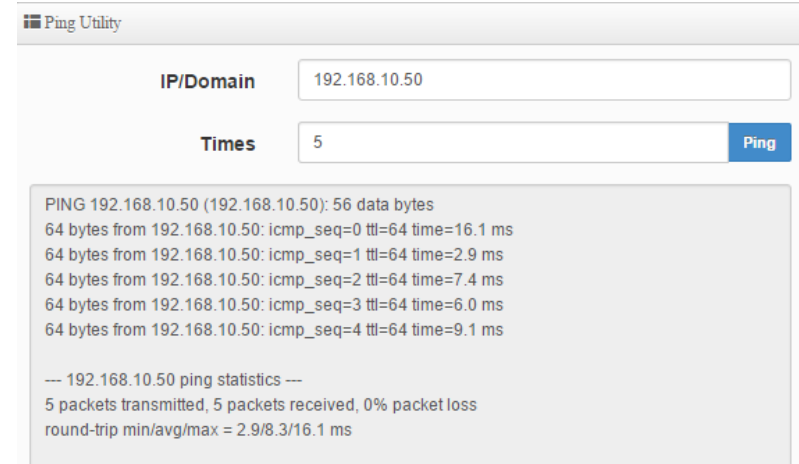

You can also check under **Wireless** and **WDS Status** the status of the wireless point to point bridge between the two access points.

MAC Address	Rate(RX/TX)	RSSI
00:11:22:33:44:00	39Mb / 52Mb	69

**Note:** If the connectivity test fails, wait for about 1 minute and try again. Make sure there are no obstacles between two access points and that they are not too close together.

## Ground Wire and Pole Mount Installation

1. Locate the grounding point located in bottom section of the enclosure. Using a Phillips screwdriver, remove the ground point screw (counter clockwise) and attach the included grounding wire to the ground point screw. Reattach the ground screw (clockwise) along with the grounding wire. After installing the grounding wire, remove another tab on the enclosure by gently bending back and forth until the tab is removed. This will create the opening for the ground cable to be routed through.

**Note:** The ground wire may need to be cut and extended using additional ground wire in order to reach a proper ground point.

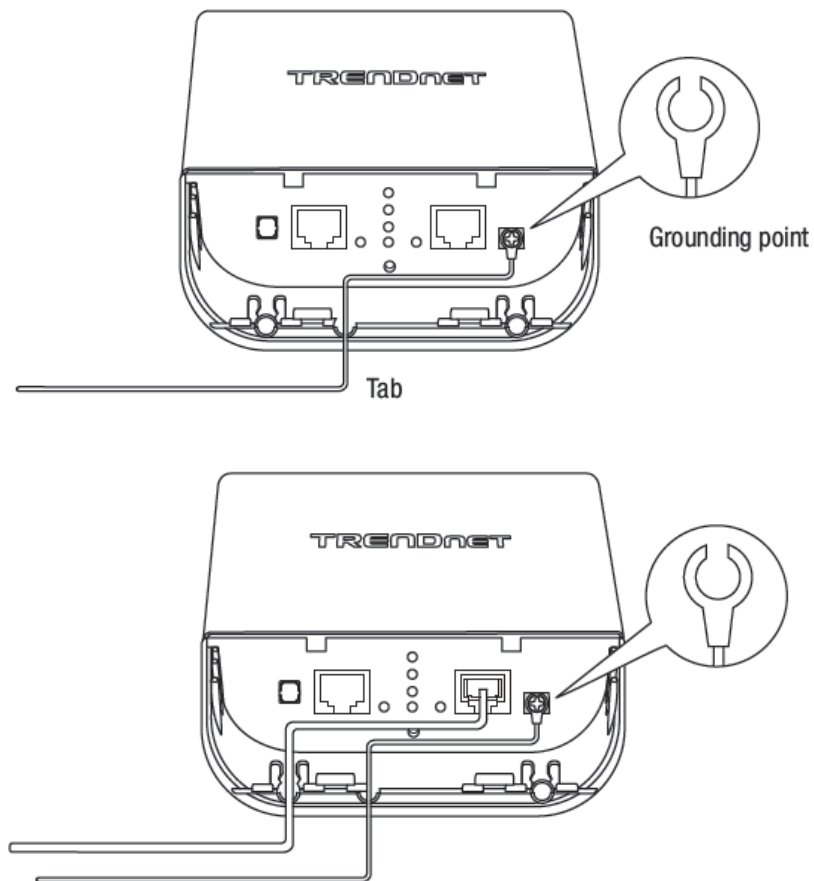

2. Reinstall the cover by lining up the guides into the notches as shown and push the cover down until the cover clips in and is secured.

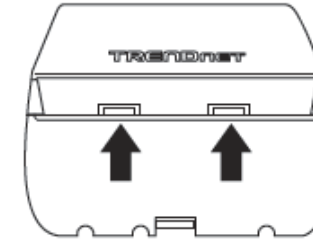

3. Insert the included fasteners through the holes located at the back of the access point.

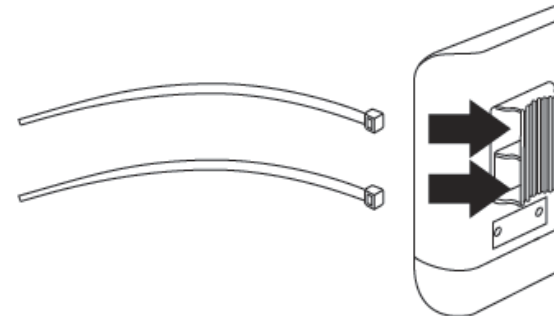

4. Wrap the fasteners around the pole where the access point will be installed. On the fasteners, insert the open end into the locking mechanism and pull tight until the point is secured.

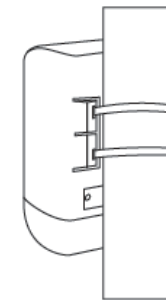

5. After the access points are properly mounted, you can connect the grounding wires to the proper ground points and RJ-45 cables from each access point PoE injector to your network.

**Completed Installation Reference**

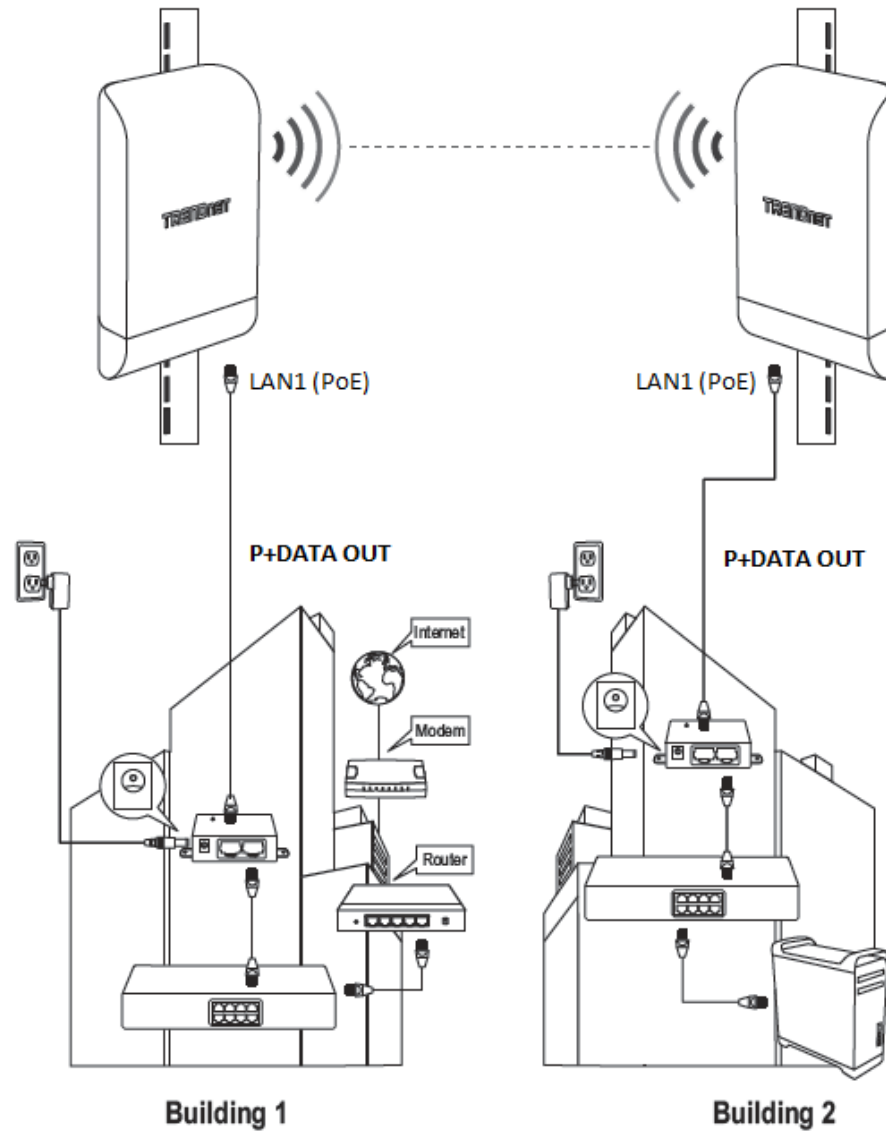

## TEW-740APBO2K Setup and Installation

When purchasing the access point bridge kit, mode TEW-740ABPO2K, by default, the TEW-740APBO access points are preconfigured to establish a point-to-point WDS bridge between each other using a unique predefined AES encryption key. For convenience, a unique predefined admin password has already been assigned to both access points. You can find the preconfigured access point settings on the wireless sticker or on the device label beneath the cover where the Ethernet ports and LEDs are located. No additional configuration is required. Ma

Unit 1

Preset Wireless Settings

Mode/WiFi Channel	WDS Bridge/CH 1
AES Encryption Key	740XXXXXXXXX

*Management Login*  
http://192.168.10.50  
username: admin  
password: XXXXXXXX

Unit 2

Preset Wireless Settings

Mode/WiFi Channel	WDS Bridge/CH 1
AES Encryption Key	740XXXXXXXXX

*Management Login*  
http://192.168.10.51  
username: admin  
password: XXXXXXXX

On the device label located inside, you can also find the preconfigured default settings of each access point.

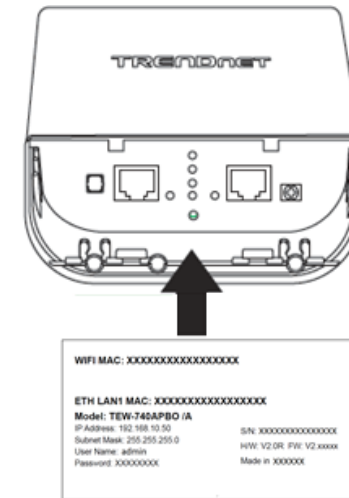

The TEW-740APBO access points will be preconfigured with the following settings:

	TEW-740APBO #1	TEW-740APBO #2
<b>IP Address</b>	192.168.10.50	192.168.10.51
<b>Netmask (Subnet Mask)</b>	255.255.255.0	255.255.255.0
<b>IP Gateway (Default Gateway)</b>	192.168.10.1	192.168.10.1
<b>Primary DNS</b>	192.168.10.1	192.168.10.1
<b>Wireless Channel (Default)</b>	1	1
<b>Mode</b>	WDS	WDS
<b>WDS Encryption</b>	AES	AES

### Setup and Confirm Connectivity

1. Remove the cover of the access points by pulling and holding the tab in the vertical direction upward (as shown in the picture below) and sliding the cover in the two locations noted away from the access point.

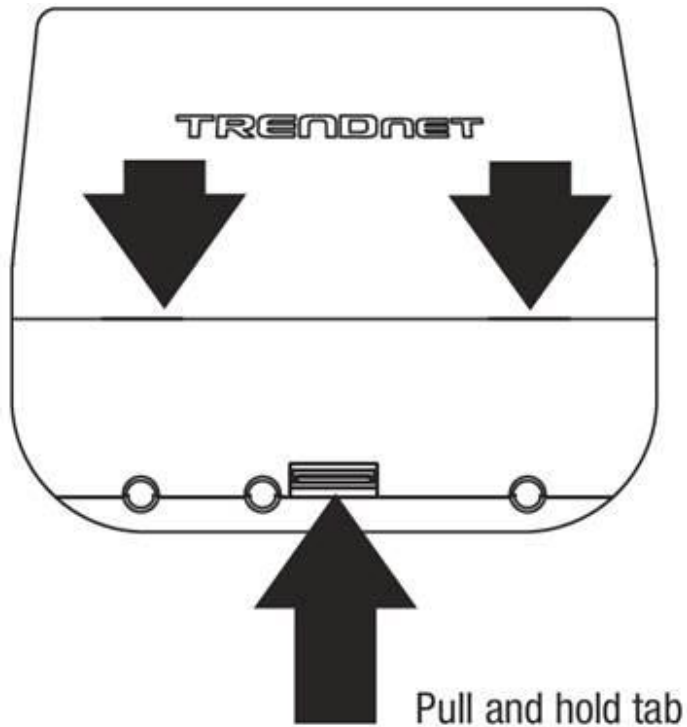

2. Remove the tab on the far left by gently bending it back and forth until the tab is removed. This will create the opening the RJ-45 network cable to be routed through.

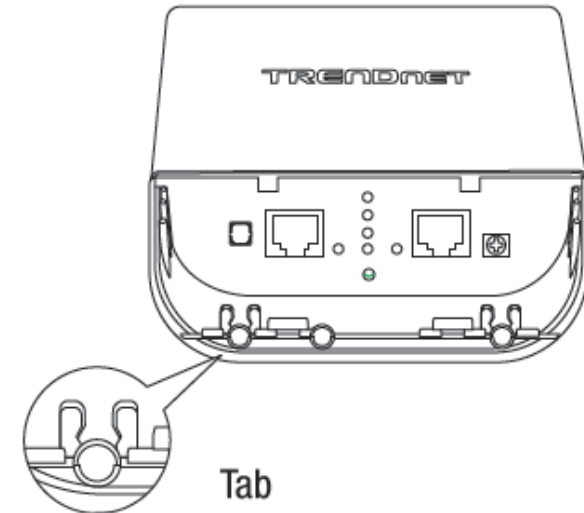

3. Using a RJ-45 network cable, connect one end of the cable to the LAN (PoE) port and push the cable into the guide on the far left, then through the opening that was created in the previous step.

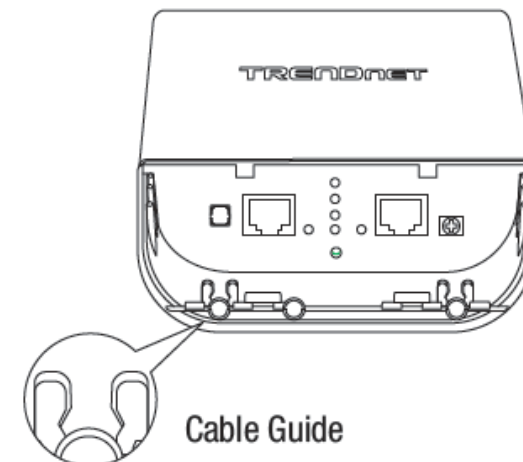

4. Connect the other end of the RJ-45 network cable to the **P+DATA OUT** port on the included PoE injector.
5. Connect the included power adapter to the PoE injector **POWER IN** on the included PoE injector.
6. Plug the connected power adapter into a power outlet.
7. Confirm the device is powered on through the **PWR** LED indicator.

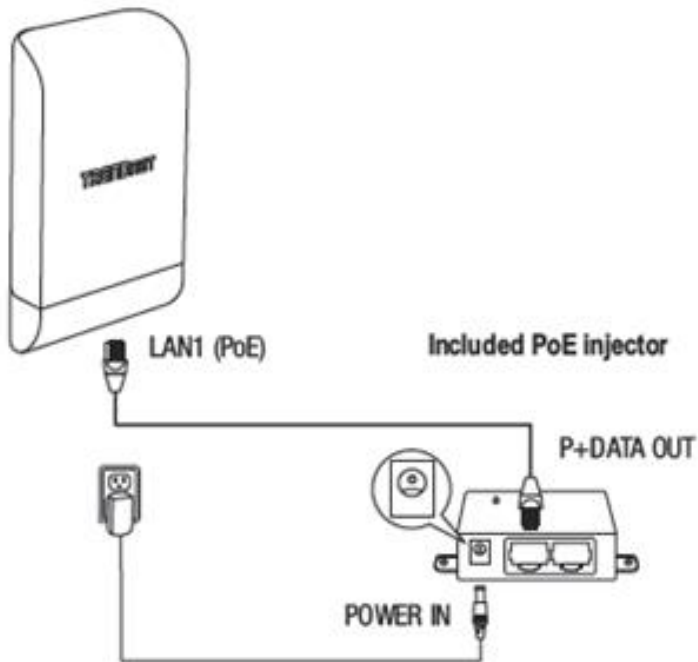

**Note:** Repeat steps 1-7 to power on and connect the second access point.

8. Assign a static IP address to your computer's network adapter in the subnet of 192.168.10.x (e.g. 192.168.10.10) and subnet mask of 255.255.255.0.
9. Using another network cable, connect one end to the **10/100 DATA IN** port on the included PoE injector for either the first or second access point.
10. Connect the other end of the network cable to your computer's Ethernet port.

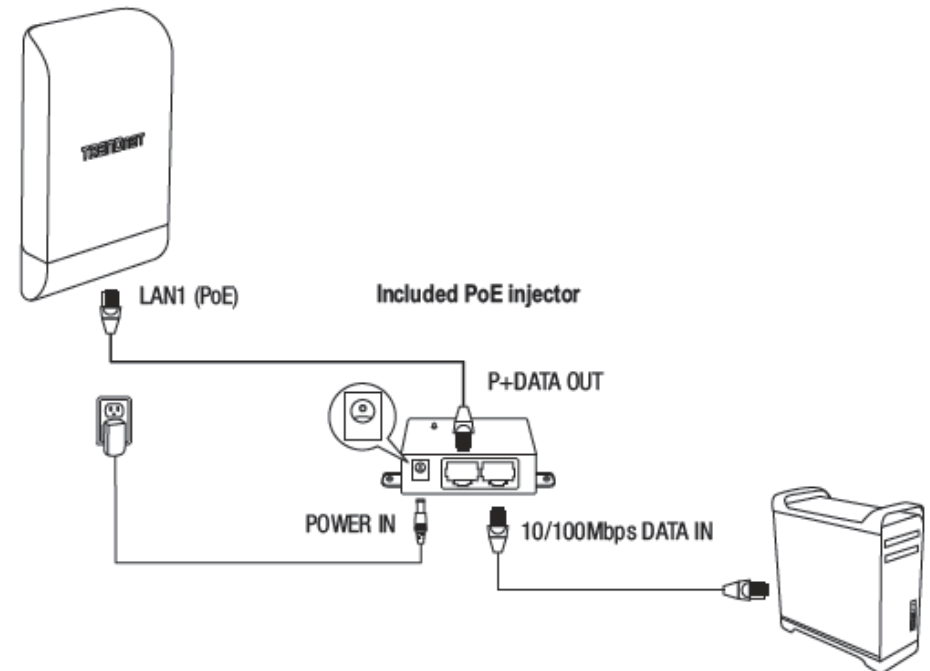

11. Make sure both access points are powered on approximately 15 ft. (5 m) apart from one another with front of access points directly facing each other.

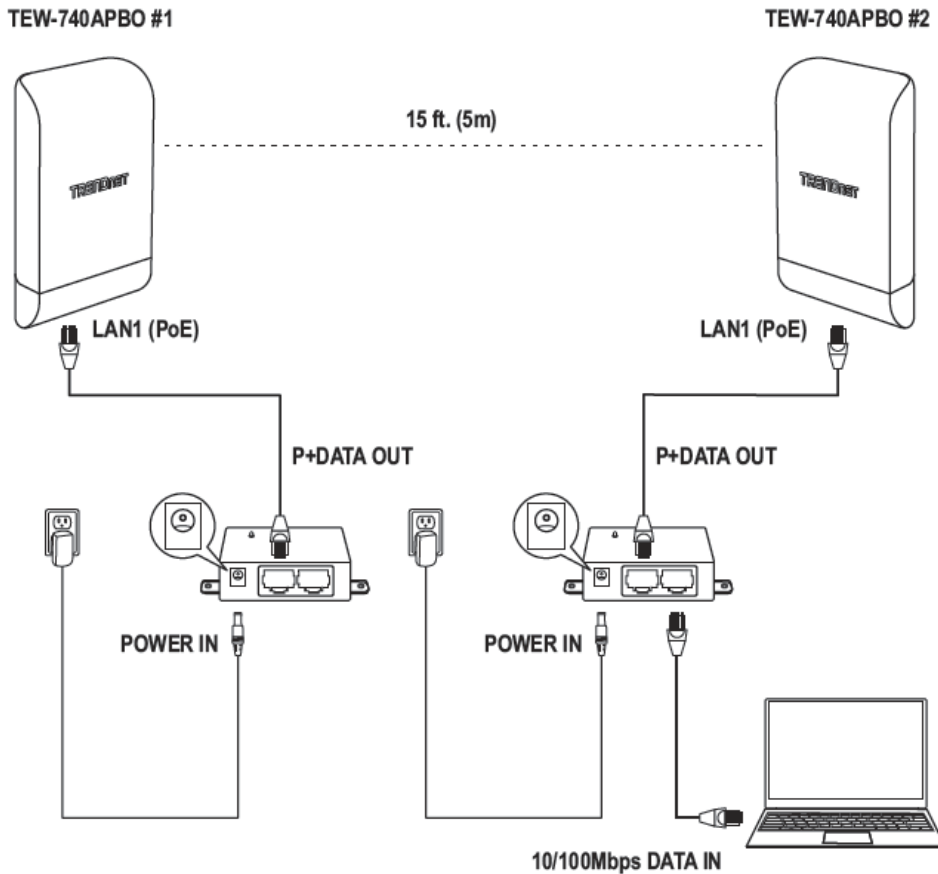

12. To verify connectivity on your computer, open a command prompt or terminal application window and type in the following commands.

**Note:** In Windows®, you can use the Command Prompt application and in Mac®, you can use the Terminal application to run the commands for connectivity testing.

```
ping 192.168.10.50
```

<Press Enter and wait for result>

```
ping 192.168.10.51
```

<Press Enter and wait for result>

A successful connectivity test will appear similar to the result below for each access point. Ping replies and 0% packet loss will indicate a successful point to point bridge connection between the two access points.

```
C:\WINDOWS\system32>ping 192.168.10.50

Pinging 192.168.10.50 with 32 bytes of data:
Reply from 192.168.10.50: bytes=32 time<1ms TTL=64
Reply from 192.168.10.50: bytes=32 time<1ms TTL=64
Reply from 192.168.10.50: bytes=32 time=1ms TTL=64
Reply from 192.168.10.50: bytes=32 time<1ms TTL=64

Ping statistics for 192.168.10.50:
    Packets: Sent = 4, Received = 4, Lost = 0 (0% loss),
    Approximate round trip times in milli-seconds:
        Minimum = 0ms, Maximum = 1ms, Average = 0ms

C:\WINDOWS\system32>ping 192.168.10.51

Pinging 192.168.10.51 with 32 bytes of data:
Reply from 192.168.10.51: bytes=32 time=2ms TTL=64
Reply from 192.168.10.51: bytes=32 time=3ms TTL=64
Reply from 192.168.10.51: bytes=32 time=2ms TTL=64
Reply from 192.168.10.51: bytes=32 time=5ms TTL=64

Ping statistics for 192.168.10.51:
    Packets: Sent = 4, Received = 4, Lost = 0 (0% loss),
    Approximate round trip times in milli-seconds:
        Minimum = 2ms, Maximum = 5ms, Average = 3ms
```

**Note:** If the connectivity test fails, wait for about 1 minute and try again. Make sure there are no obstacles between two access points and that they are not too close together.

## Ground Wire and Pole Mount Installation

1. Locate the grounding point located in bottom section of the enclosure. Using a Phillips screwdriver, remove the ground point screw (counter clockwise) and attach the included grounding wire to the ground point screw. Reattach the ground screw (clockwise) along with the grounding wire. After installing the grounding wire, remove another tab on the enclosure by gently bending back and forth until the tab is removed. This will create the opening for the ground cable to be routed through.

**Note:** The ground wire may need to be cut and extended using additional ground wire in order to reach a proper ground point.

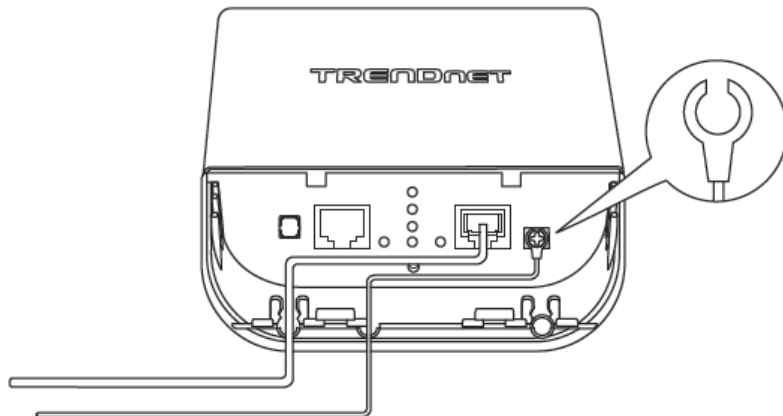
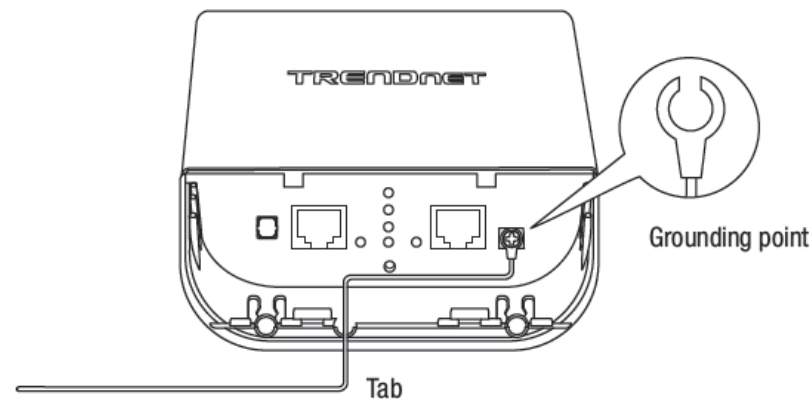

2. Reinstall the cover by lining up the guides into the notches as shown and push the cover down until the cover clips in and is secured.

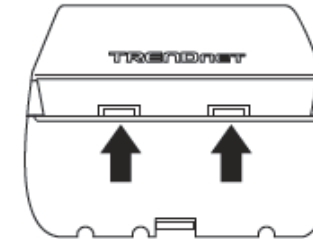

3. Insert the included fasteners through the holes located at the back of the access point.

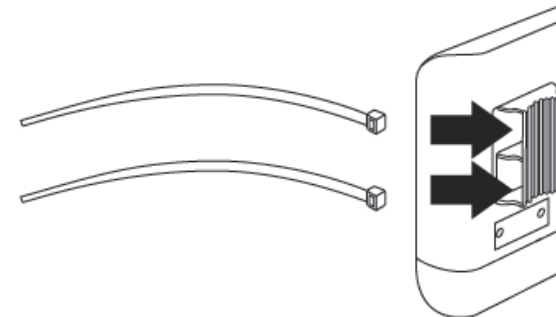

4. Wrap the fasteners around the pole where the access point will be installed. On the fasteners, insert the open end into the locking mechanism and pull tight until the point is secured.

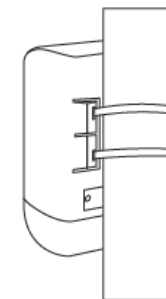

5. After the access points are properly mounted, you can connect the grounding wires to the proper ground points and RJ-45 cables from each access point PoE injector to your network.



**Completed Installation Reference**

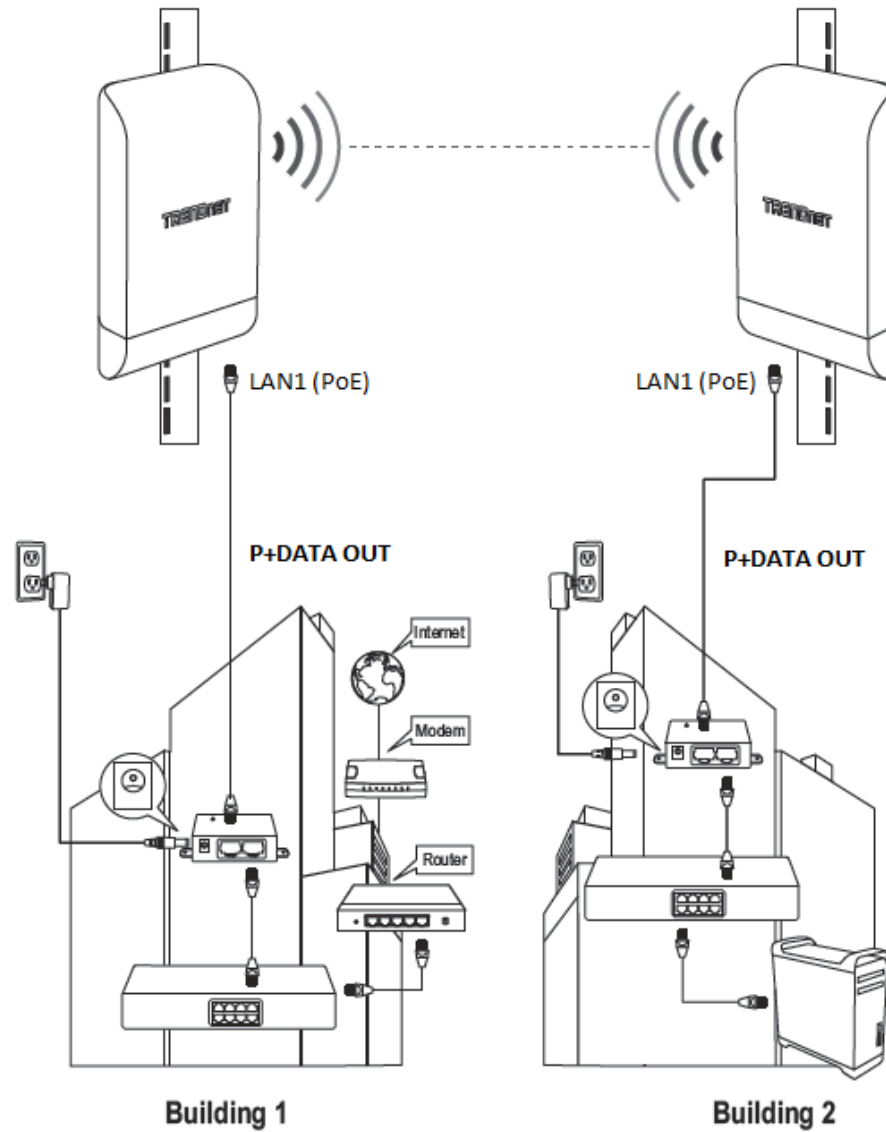

## Wireless Installation Tips

There are a number of factors that can impact the range of wireless devices.

1. Adjust your wireless devices so that the signal is traveling in a straight path, rather than at an angle. The more material the signal has to pass through the more signal you will lose.
2. Keep the number of obstructions to a minimum. Each obstruction can reduce the range of a wireless device. Position the wireless devices in a manner that will minimize the amount of obstructions between them.
3. Building materials can have a large impact on your wireless signal. In an indoor environment, try to position the wireless devices so that the signal passes through less dense material such as dry wall. Dense materials like metal, solid wood, glass or even furniture may block or degrade the signal.
4. Antenna orientation can also have a large impact on your wireless signal. Use the wireless adapter's site survey tool to determine the best antenna orientation for your wireless devices.
5. Interference from devices that produce RF (radio frequency) noise can also impact your signal. Position your wireless devices away from anything that generates RF noise, such as microwaves, radios and baby monitors.

If you are still experiencing low or no signal consider repositioning the wireless devices or installing additional access points. The use of higher gain antennas may also provide the necessary coverage depending on the environment. Please note to use the wireless connection quality indicators during installation to determine the optimal positioning when mounting your access points.

## Application Modes

Although the access point is intended to be used for primarily WDS point-to-point bridging, the access point offers other operating modes. The access point multiple mode system which can be configured either as a wireless gateway or an access point as desired. It also can be used as a WDS (Wireless Distribution System) link for Ethernet network expansion. This section explains the different modes the access point has available, **Access (AP) Mode**, **AP + WDS Mode**, **WDS Mode**, **Client Bridge + AP Mode**, **WISP (CPE) + AP Mode**, **Router Mode**, and **CAP (Control AP) Mode**.

The different modes can be found under *System > Mode Setup* in the access point web management page.

### AP Mode (Access Point Mode)

An access point can be either a main, relay or remote base station. A main base station is typically connected to a wired network via the Ethernet port. A relay base station relays data between main base stations and relay stations or remote base stations with clients. A remote base station is the end point to accept connections from wireless clients and pass data upstream to a network wirelessly.

#### Example 1: Access Point Only

- It can be deployed as a traditional fixed wireless access point.

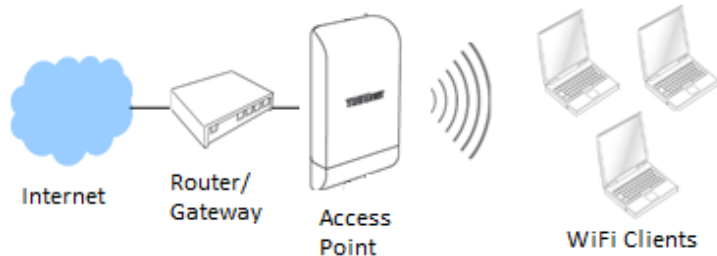

#### Example 2: Access Point + WDS Bridging

- It can be deployed as a traditional fixed wireless access point and establish WDS bridging to an upstream access point to expand a network.

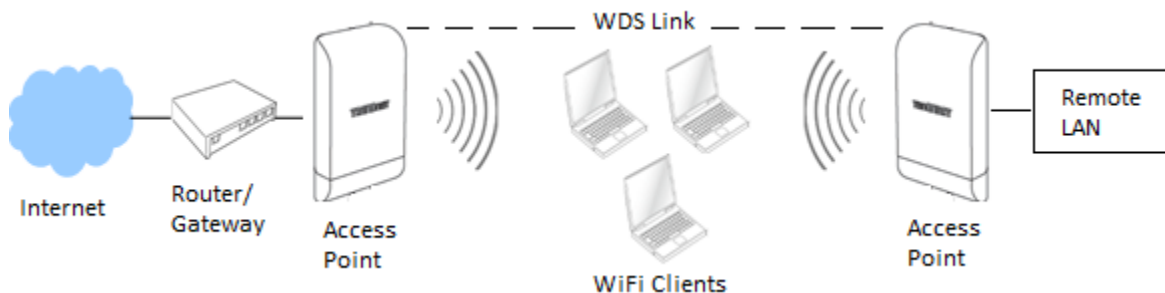

## WDS Mode (Pure WDS)

This is the primary application mode for the TEW-740APBO and TEW-740APBO2K. The built-in high gain directional antenna makes this access point an ideal solution for establishing a single WDS point-to-point wireless bridge or link between two physical locations that are a great distance from one another.

### Example 1: Point-to-Point

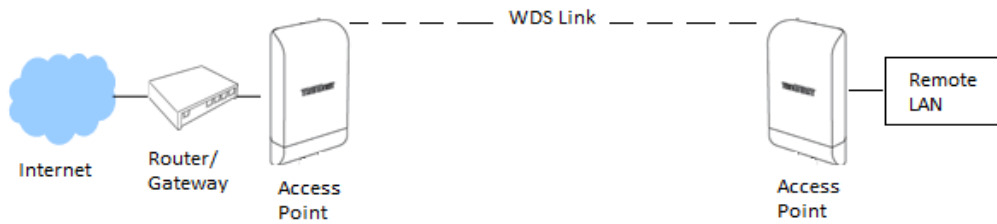

### Example 2 : Point-to-Multi-Point

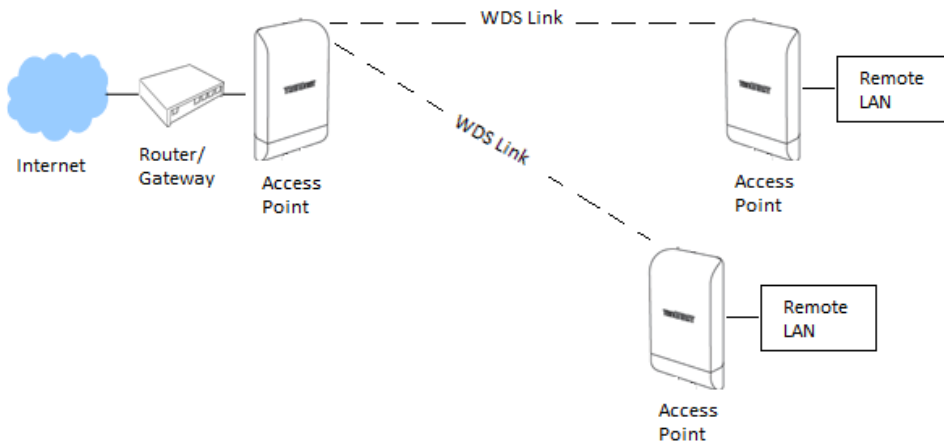

**Client Bridge + AP Mode**

It can be used as a Client Bridge + AP to receive wireless signal over last mile applications, helping WISPs deliver wireless broadband Internet service to new residential and business customers. In this mode, the access point is enabled with DHCP Server functions. In this mode, the AP functions similar to that of a wireless client or station such as mobile phone, tablet, or notebook computer, however is also capable of broadcasting wireless signal for other wireless clients to connect. The wired ports LAN1 (PoE) and LAN2 are logically bridged to the wireless interface. The wired clients of access point are in the same subnet from Main Base Station and it accepts wireless connections from client devices.

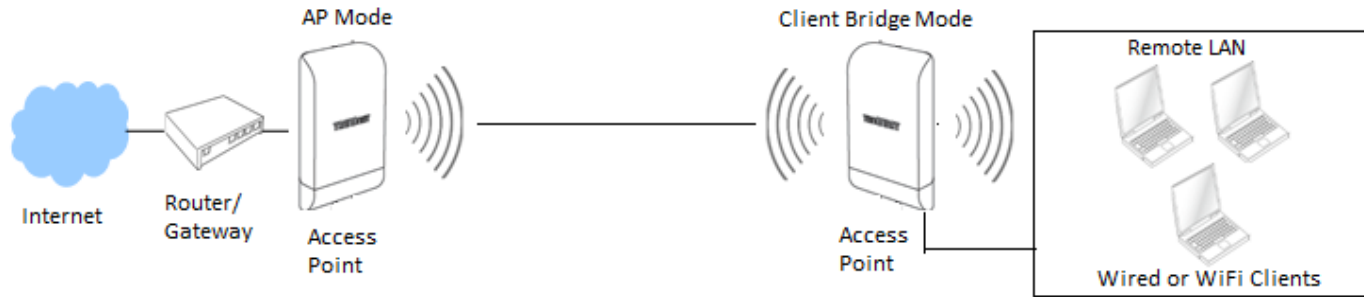

**WISP (CPE) + AP Mode**

It can be used as an Outdoor Customer Premised Equipment (CPE) to receive wireless signal over the last mile, helping WISPs deliver wireless broadband Internet service to new residential and business customers. This In this mode, the access point wireless interface connects to the wireless Internet service provider (WISP) and acts as the Internet or WAN Interface. The wired interfaces LAN1 (PoE) and LAN2 operate as the LAN local interface with NAT and DHCP Server functions and wireless interface operates as the WAN Internet interface.

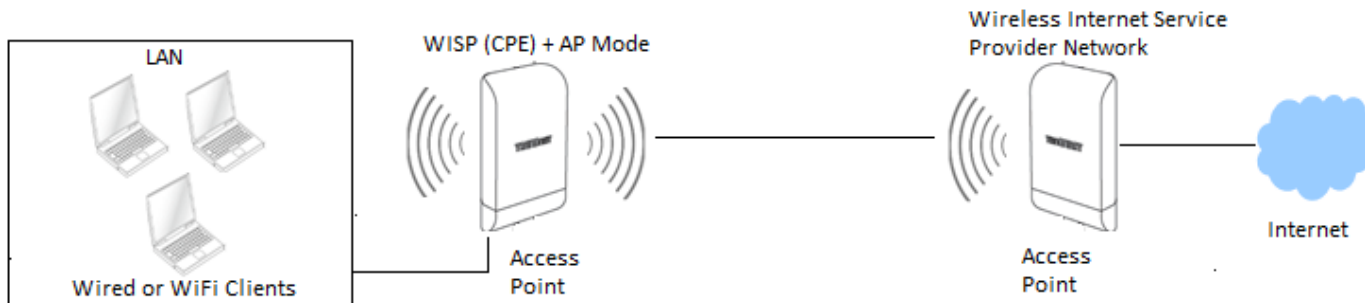

### Router Mode

Router mode allows you to use the access point as a NAT router/gateway. LAN1 (PoE) operates as the wired WAN Internet interface and LAN2 and wireless interfaces operates as the LAN local interface with NAT and DHCP Server functions.

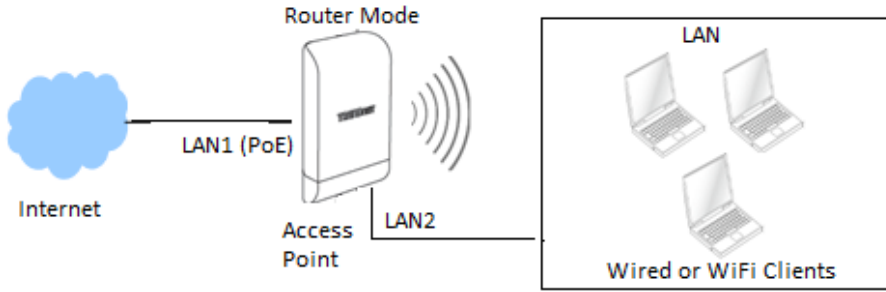

### CAP (Control AP) Mode

CAP mode functions in AP mode but in addition, this mode allows you to manage, monitor, and control other APs using the same firmware/software. You can configure multiple settings for multiple APs at the same time, push out batch firmware upgrades from one convenient GUI interface. The CAP Mode AP can discover and manage any CAP mode compatible APs on any of interfaces including WDS bridged links. **Note:** Currently, the only TRENDnet TEW-740APBO (H/W: v2.XR) is CAP mode firmware/software compatible.

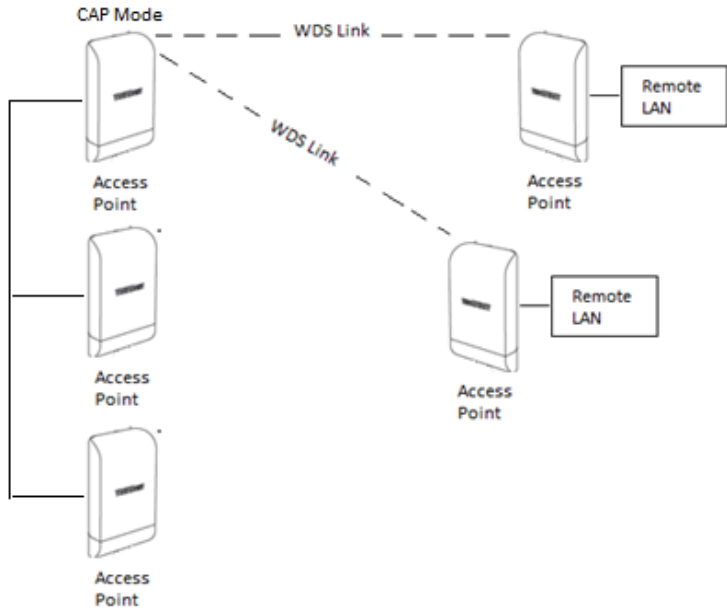

## Access your access point management page

**Note:** TEW-740APBO Users: Your access point management page default IP address <http://192.168.10.100> is accessed through the use of your Internet web browser (e.g. Internet Explorer®, Firefox®, Chrome™, Safari®, Opera™) and will be referenced frequently in this User's Guide.

TEW-740APBO2K Users: Your access point management page default IP addresses are <http://192.168.10.50> and <http://192.168.10.51>. Additionally, the pre-defined user name and password will be unique. This information will be printed on both the wireless stickers and device label located inside the access point enclosure.

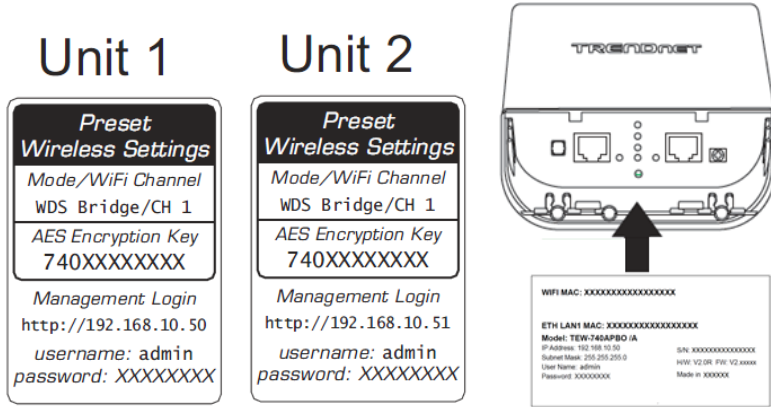

If you have changed the default IP address, you will need to ensure that your computer is configured with IP address settings in the same subnet as the as the access point in order to access the access point management page. Also, make sure your access point is powered on through the included PoE injector and your computer is connected to the 10/100 DATA IN port on injector or connect to LAN2 Ethernet port. (Ex. Access Point IP address changed to 192.168.0.100 / 255.255.255.0, example computer address 192.168.0.25 / 255.255.255.0).

1. Open your web browser and go to the address <http://192.168.10.100> (TEW-740APBO) or <http://192.168.10.50> and <http://192.168.10.51> (TEW-740APBO2K). Your access point will prompt you for a user name and password.

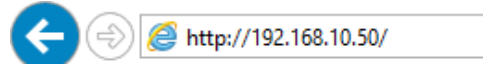

2. TEW-740APBO Users: By default, the user name is *admin* and password is *admin*. TEW-740APBO2K Users: You can also find the wireless settings sticker included with the access points and on the device inside the access point enclosure. Enter your **Username** and **Password**, then click **Login**.

**Note:** If you have changed the password already such as in the Setup Wizard, you will need to login using the new password. User Name and Password are case sensitive.

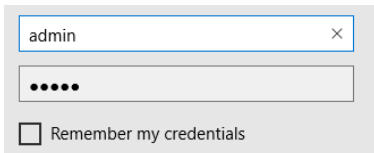

## AP Management Settings

### Management Setup

System > Management

These settings will allow you to configure the AP system information, administrator password, management access methods, external logging, and automatic reboot schedule.

1. Log into your access point management page (see "[Access your access point management page](#)" on page 28).
2. Click **System** and click on **Management**. Review the settings and click **Save** to apply the changes.

#### System Information

- **System Name** – Specifies the device or hostname of the AP for easily identifying the device and network management purposes.
- **Description** – Specifies a brief description of the device for easily identifying the device and network management purposes.
- **Location** – Specifies the location of the device relative to the network for easily identify the device and network management purposes.

**System Information**

<b>System Name</b>	<input type="text" value="TEW-740APBO"/>
<b>Description</b>	<input type="text" value="10 dBi Wireless N300 Outdoor PoE Access Point."/>
<b>Location</b>	<input type="text"/>

#### Administrator Password

- **New/Check Admin Password** – To change the default administrator password, enter the new password in the field provide and again in the check field to confirm the password change.

**Administrator Password**

<b>New Admin Password</b>	<input type="password"/>
<b>Check Admin Password</b>	<input type="password"/>

#### Login Methods

- **HTTP** – The standard unsecured web GUI method is enabled by default. Check the box to enable or disable management access to the device via http web GUI access. You can also check the default port used for management access.
- **HTTPS** – This type of management access is also through the web GUI but secured using SSL (Secure Socket Layer) encryption. The default port may also be changed. Additionally, you can upload your own SSL certificate under Utility > Profile Settin.
- **Telnet** – This type of unsecured management access is through the CLI (Command Line Interface) through the AP IP address and has been disabled by default for security purposes. The default port may also be changed.
- **SSH** – This type of secured and encrypted management access is also through the CLI (Command Line Interface) through the AP IP address. The default port may also be changed. For additional security, the Host Key Footprint may also be changed by clicking **Generate Key**.

**Login Methods**

<b>HTTP</b>	<input checked="" type="checkbox"/>	<input type="text" value="80"/>	Port
<b>HTTPS</b>	<input type="checkbox"/>	<input type="text" value="443"/>	Port
<b>Telnet</b>	<input type="checkbox"/>	<input type="text" value="23"/>	Port
<b>SSH</b>	<input type="checkbox"/>	<input type="text" value="22"/>	Port
<b>Host Key Footprint</b>	<input style="width: 100%;" type="text" value="ssh-rsa AAAAB3NzaC1yc2EAAAADAQABAAQ="/>		<b>Generate Key</b>



### System Log Setup

- **Remote Server** – To enable external logging to be sent, check the option and enter the IP address of the remote logging server (Syslog Server).
- **Port** – By default, Syslog logging uses port UDP 514 but can be changed. Please note the port would also need to be changed on external Syslog server.

 System Log Setup

**Remote Server**

**Port**

### Auto Reboot

- **Type** – Click the drop-down list and select the frequency of when the AP will auto reboot, Daily, Weekly, or Monthly.
  - **Daily** – The AP will auto reboot once a day. Specify the time when to initiate the device reboot.
  - **Weekly** – The AP will auto reboot once a week. Specify the day of the week and time when to initiate the device reboot.
  - **Monthly** – The AP will auto reboot once a month. Specify the day of the month and the time to initiate the device reboot.

 Auto Reboot

**Type**

**Hour**

**Minute**

### Set the device date and time

System > Time

1. Log into your access point management page (see "[Access your access point management page](#)" on page 28).
2. Click **System** and click on **Time**. Review the settings and click **Save** to apply the changes.

- **Local Time** – Displays the current device date and time.
- **Mode:**
- **NTP Server** – The device will obtain the date and time information automatically from an external NTP server. Please note that the default gateway IP address and DNS must be configured properly to access an NTP server located on the Internet.
  - **Default NTP Server** – Click the drop-down list and select an available NTP server from the list.
  - **NTP Server** – Allows you to manually enter an NTP server that is not available in the predefined NTP server list.
  - **Time Zone** – Click the drop-down list and select the correct Time Zone.
  - **Daylight Savings Time** – Enable or Disable the daylight savings time function if it is currently active in your region.
- **Manual** – Allows you to manually set the device date and time.
  - **Date (Y/M/D)** – Click drop-down lists to set the correct date manually. Year / Month / Day
  - **Time (H:M:S)** – Click the drop-down lists to set the correct time manually. Hour:Minute:Second.

**System Time**

Local Time: 2016/12/08 16:00:24

Mode:  NTP Server  Manual

**NTP Server**

Default NTP Server: time.trendnet.com

NTP Server: time.trendnet.com

Time Zone: (GMT-08:00) Pacific Time (US & Canada)

Daylight Saving Time:  Enable  Disable

**System Time**

Local Time: 2016/12/08 16:00:47

Mode:  NTP Server  Manual

**User Setup**

Date(Y/M/D): 2016 12 8

Time(H:M:S): 16 0 29 (GMT+8:00)

## SNMP Settings

System > SNMP

### SNMP v2c

1. Log into your access point management page (see "[Access your access point management page](#)" on page 28).
2. Click **System** and click on **SNMP**. Review the settings and click **Save** to apply the changes.
  - **Active** – Enable or disable SNMP version 2c.
  - **RO Community** – Enter the read only community name.
  - **RW Community** – Enter the ready/write community name.

**SNMP v2c**

Active  Enable  Disable

RO Community:

RW Community:

## SNMP v3

1. Log into your access point management page (see "[Access your access point management page](#)" on page 28).
2. Click **System** and click on **SNMP**. Review the settings and click **Save** to apply the changes.
  - **Active** – Enable or disable SNMP version 3.
  - **RO Username** – Enter the read only user name.
  - **RO Password** – Enter the read only password.
  - **RW Username** – Enter the read/write user name.
  - **RW Password** – Enter the read/write password.

SNMP v3

Active
  Enable
  Disable

RO Username

RO Password

RW Username

RW Password

## SNMP Trap

1. Log into your access point management page (see "[Access your access point management page](#)" on page 28).
2. Click **System** and click on **SNMP**. Review the settings and click **Save** to apply the changes.
  - **Active** – Enable or disable SNMP Trap.
  - **Community** – Enter the community name for SNMP trap.
  - **IP 1** – Enter the IP address of the 1<sup>st</sup> SNMP trap receiver.
  - **IP 2** – Enter the IP address of the additional SNMP trap receiver.
  - **IP 3** – Enter the IP address of the additional SNMP trap receiver.
  - **IP 4** – Enter the IP address of the additional SNMP trap receiver.

SNMP Trap

Active
  Enable
  Disable

Community

IP 1

IP 2

IP 3

IP 4

## Backup and restore your AP configuration settings

Utility > Profile Setting

### Backup configuration settings

1. Log into your access point management page (see "[Access your access point management page](#)" on page 28).
2. Click **Utility** and click on **Profile Setting**.
3. Next to **Save Settings To PC**, click **Save**.

A blue rectangular button with the word "Save" in white text.

Depending on your web browser settings, you may be prompted to save a file (specify the location) or the file may be downloaded automatically to the web browser settings default download folder. (Default Filename: *config.bin*)

### Restore configuration settings

1. Log into your access point management page (see "[Access your access point management page](#)" on page 28).
2. Click **Utility** and click on **Profile Setting**.
3. Next to **Load Settings From PC**, click **Browse** or **Choose File**.

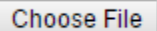
A light gray button with the text "Choose File" in blue and "No file chosen" in gray.

4. A separate file navigation window should open.
5. Select the configuration file to restore and click **Upload**. (Default Filename: *config.bin*). If prompted, click **Yes** or **OK**.

A blue rectangular button with the word "Upload" in white text.

6. Wait for the device restore settings.

## Reset your AP to factory defaults

Utility > Profile Setting

You may want to reset your device to factory defaults if you are encountering difficulties and have attempted all other troubleshooting. Before you reset to defaults, if possible, you should backup your router configuration first. If you are using are resetting an AP from the TEW-740APBO2K Bridge Kit, the APs will default to the original predefined settings which can be located on the device label inside the enclosure or predefined sticker.

There are two methods that can be used to reset your device to factory defaults.

- **Reset Button** – Located inside the enclosure where Ethernet ports and LEDs are located. Use this method if you are encountering difficulties with accessing your router management page.

**OR**

- **Management Page**

1. Log into your access point management page (see "[Access your access point management page](#)" on page 28).
2. Click **Utility** and click on **Profile Setting**.
3. Next to **Reset To Factory Default**, click **Default**.

## Soft reboot your AP

Utility > Reboot

1. Log into your access point management page (see "[Access your access point management page](#)" on page 28).
2. Click **Utility** and click on **Network Utility**.
3. Click **Reboot**.

A blue rectangular button with the word "Reboot" in white text.

## Upgrade your AP firmware

*Utility > System Upgrade*

TRENDnet may periodically release firmware upgrades that may add features or fix problems associated with your TRENDnet device and date/version. To check if there is a firmware upgrade available for your device, please check your TRENDnet model and version using the link. <http://www.trendnet.com/downloads/>

In addition, it is also important to verify if the latest firmware version is newer than the one your AP is currently running. To identify the firmware that is currently loaded on your AP, log in to the AP, click on Utility > Status. The firmware version and date used by the AP will be displayed. If there is a newer version available, also review the release notes to check if there were any new features you may want or if any problems were fixed that you may have been experiencing.

1. If a firmware upgrade is available, download the firmware to your computer.
2. Unzip the file to a folder on your computer.

### Please note the following:

- Do not interrupt the firmware upgrade process. Do not turn off the device or press the Reset button during the upgrade.
- If you are upgrade the firmware using a laptop computer, ensure that the laptop is connected to a power source or ensure that the battery is fully charged.
- Disable sleep mode on your computer as this may interrupt the firmware upgrade process.
- Do not upgrade the firmware using a wireless connection, only using a wired network connection.
- Any interruptions during the firmware upgrade process may permanently damage your router.

3. Log into your access point management page (see "[Access your access point management page](#)" on page 28).
4. Click **Utility** and click on **System Upgrade**.
5. Next to **Upgrade Via Local PC**, click **Browse** or **Choose File**.

Choose File No file chosen

6. A separate file navigation window should open.

7. Select the firmware file to restore and click **Upload**. If prompted, click **Yes** or **OK**.

Upload

### Other Firmware Upgrade Methods:

- **Via TFTP Server** – If you have a computer running as a TFTP server or running third party TFTP server software, you can copy the file to your TFTP server computer, enter the TFTP server IP address and firmware filename, then click **Upload**.
- **Via HTTP URL** – If you have the firmware file loaded to an HTTP web server and the file is downloadable via link, enter the URL link to the firmware download and click **Upload**.

## Network Utilities

*Utility > Network Utility*

The built-in network test utilities ping and traceroute can be used for troubleshooting purposes.

1. Log into your access point management page (see "[Access your access point management page](#)" on page 28).

2. Click **Utility** and click on **Network Utility**.

- **Ping Utility** – Enter the IP/Domain address to test connectivity and enter the amount of ping requests sent, click Ping.
- **Traceroute** – Enter the Destination Host IP address to test and enter the maximum number of router hops allowed.

## View system information

Status > Overview

This page will display the AP system summary information such as the currently operating mode, system time, firmware version, MAC and IP address settings WiFi information.

1. Log into your access point management page (see "[Access your access point management page](#)" on page 28).
2. Click **Status** and click on **Overview**.

Overview

<b>Mode</b>	CAP Mode
<b>System Name</b>	TEW-740APBO
<b>System Time</b>	2014/12/31 16:13:13
<b>System Uptime</b>	10:55
<b>Firmware Version</b>	Pme-CPE-AP12X V2.0R
<b>Firmware Date</b>	2016/12/08 13:33:58
<b>LAN1 MAC Address</b>	00:22:aa:00:12:0a
<b>LAN2 MAC Address</b>	00:22:aa:00:12:09
<b>Wifi0 MAC Address</b>	00:22:aa:00:12:0b
<b>Gateway</b>	192.168.10.1
<b>DNS1</b>	192.168.10.1
<b>DNS2</b>	

Information

CPU Usage

0 % 100

Memory

0 % 100

Wireless Client

0 People 100

Radio 0

<b>Band Mode</b>	802.11b/g/n
<b>Channel</b>	1
<b>Rate</b>	144.4 Mb/s
<b>TX Power</b>	29dbm (794mw)

## View currently connected wireless client devices

Status > Wireless Client

This page will display the wireless client devices that are currently connected to your AP.

1. Log into your access point management page (see "[Access your access point management page](#)" on page 28).
2. Click **Status** and click on **Wireless Client**.
  - **Radio** – Displays the radio the wireless client device is connected. Since the TEW-740APBO only has one radio (Radio 0), only Radio 0 will be shown for this model.
  - **MAC Address** – Displays the wireless client device MAC address.
  - **Rate (RX/TX)** – Displays the estimated receive and transmission rates at which the wireless client device is connected.
  - **RSSI** – Displays the estimated signal strength of the wireless client device relative to the AP. The value is a negative number, therefore, the lower the value, the better signal and connectivity of the client device.

Radio	MAC Address	Rate(RX/TX)	RSSI
Radio 0	9c:f4:8e:07:11:00	11Mb / 2Mb	52

## View currently connected authenticated users

Status > Online Users

Only when using the guest or user authentication feature, this page will display information about the currently connected authenticated users.

1. Log into your access point management page (see "[Access your access point management page](#)" on page 28).
2. Click **Status** and click on **Online Users**.

VLAN#	Authentication	User Count	Download Packets	Upload Packets	Download Bytes	Upload Bytes	Action
-	-	-	-	-	-	-	-

## View authentication log information

Status > Authentication Log

Only when using the guest or user authentication feature and authentication log has been enabled, this page will display authentication status logs and attempts for each VLAN.

1. Log into your access point management page (see "[Access your access point management page](#)" on page 28).
2. Click **Status** and click on **Authentication Log**.

Date	VLAN 0	VLAN 1	VLAN 2	VLAN 3	VLAN 4	VLAN 5	VLAN 6
-	-	-	-	-	-	-	-

## View the device system log information

Status > System Log

This page will display general device logging information about the system operation, functions, and status.

1. Log into your access point management page (see "[Access your access point management page](#)" on page 28).
2. Click **Status** and click on **System Log**.

Time	Facility	Severity	Message
2014-12-31 16:00:22	System	Info	Authentication successful for admin from 192.168.10.200
2014-12-31 16:02:31	System	Info	Authentication successful for admin from 192.168.10.25
2014-01-01 00:04:00	System	Info	SSDP[DISCOVER] 192.168.10.25 18542031-fa36-40f7-a7fe-a237fa476343

## Configuring additional application modes

### Access Point (AP) Mode

In AP mode, the access point creates a wireless network to allow wireless devices to connect and access your network. The access point allows wireless connectivity to your existing wired network by connecting directly to your wired network's router/gateway or network switch via the access point RJ-45 Ethernet port using the 10/100 DATA IN on the PoE injector or LAN2 port.

The diagram below shows your access point to your router/gateway and functioning in AP mode creating a wireless network for your wireless clients (ex. laptops, smart phones, etc.) to connect and adding wireless connectivity to an existing wired network.

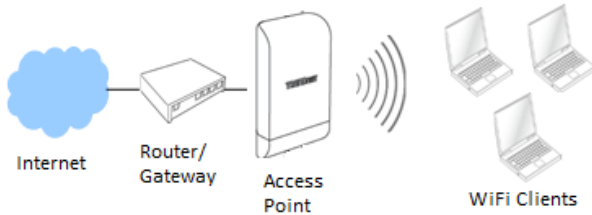

### Set the device to AP mode

*System > Mode Setup*

1. Log into your access point management page (see "[Access your access point management page](#)" on page 28).
2. Click **System** and click on **Mode Setup**.
3. Select **Access Point (AP) Mode** in the mode drop down list. Then click **Save & Reboot**.

System Mode

Mode

Access Point(AP) Mode

Save & Reboot

### Set the device LAN IP address

*System > VLAN Setup*

By default, the primary LAN interface and management interface is set to VLAN 0. You can configure up to 7 VLAN tagged interfaces. Each VLAN can be configured with its own IP address settings and SSID.

1. Log into your access point management page (see "[Access your access point management page](#)" on page 28).
2. Click **System** and click on **VLAN Setup**. In this page, you can configure the router/Internet gateway/default gateway IP address and DNS server IP addresses. (ex. 192.168.10.1)

Gateway

Default Gateway

192.168.10.1

(ex. 192.168.10.1)

DNS

DNS1

192.168.10.1

DNS2

3. For the first entry in the list VLAN #0, under the **Action** column, click **Network**.

#	VLAN Mode	Flag	IP Address	Netmask	Action
0	On	Native ETH0 Native ETH1 Access Control	192.168.10.100	255.255.255.0	Network
1	Off	ETH0.101 ETH1.101	-	-	
2	Off	ETH0.102 ETH1.102	-	-	



4. Under **IP Setup**, enter the primary LAN IP address and Subnet Mask of the device. Then click **Save**. When prompted to reboot, reboot and apply the changes.

**Note:** Please note you will need to log back into the access point management page using the new IP address settings. (ex. 192.168.10.50 / 255.255.255.0)

IP Setup

IP Mode  Enable  Disable

IP Address

Netmask

#### Additional Network Settings

- **VLAN Mode** – For each virtual AP interface, enable or disable tagged VLAN traffic.
- **IP Setup** – For each virtual AP interface, aside from the primary IP address settings assigned for VLAN 0, you can assign an IP interface for each virtual AP which can be used for management access over different VLANs/IP subnets.  
**Note:** It is recommended to leave VLAN #0 enabled for management purposes.
- **Access Point** – Enable or Disable the wireless network interface.
- **802.1d Spanning Tree** – Enable this setting only if you are using redundant wired and wireless bridged links (WDS) to prevent loops and multiple paths. Example below with redundant WDS bridge link between 3 access points.

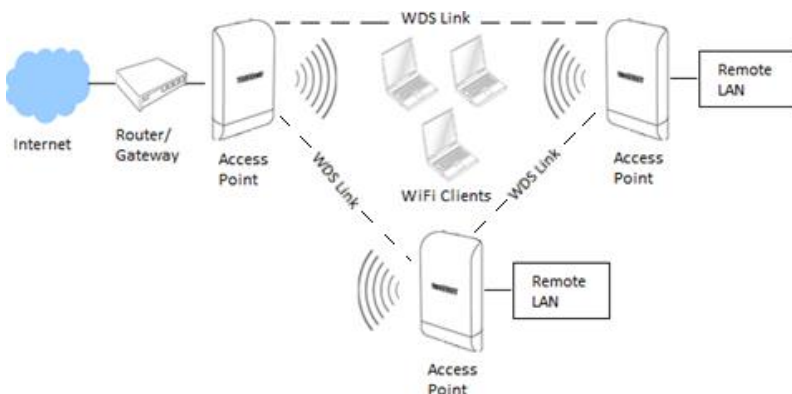

- **Control Port (Used CAP Mode Only)** – Enable this setting to allow management access from another TEW-740ABPO AP running in CAP (Control AP) mode. This will allow the management AP to push settings the current AP on the selected VLAN interface.
- **LAN1/LAN2 VLAN Tag Setup** – By default, VLANs are setup as untagged ports. To set the LAN2 Ethernet interface as a tagged member of specified VLAN, check the VLAN Tag option and enter the VLAN ID. This will allow you to map a specific wireless network to specific VLAN IDs on LAN1/2 Ethernet interfaces.  
**Note:** The example diagram below displays the access point broadcasting multiple SSIDs mapped to specific VLANs.

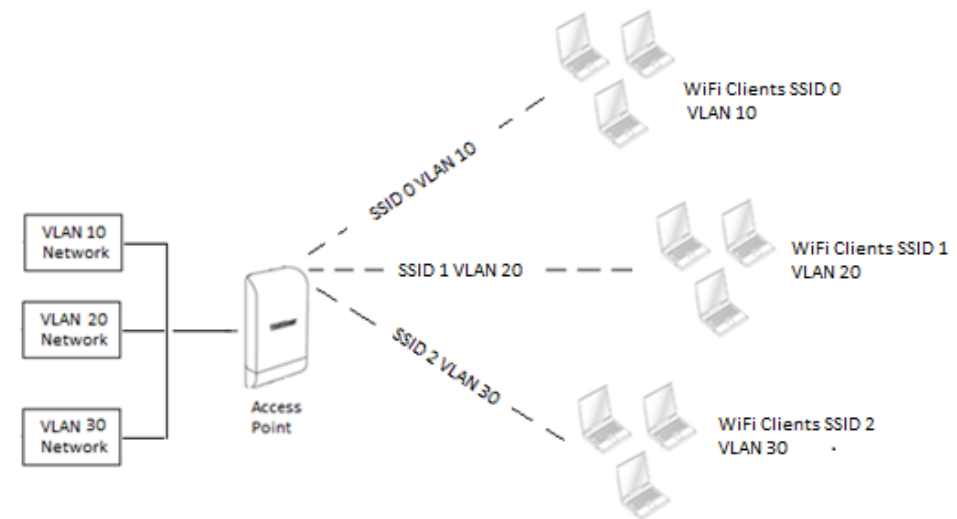

#### Configure primary wireless network settings

System > VLAN Setup > VLAN # > Access Point

1. Log into your access point management page (see "[Access your access point management page](#)" on page 28).
2. Click **System** and click on **VLAN Setup**.

- For the first entry in the list VLAN #0, under the **Action** column, click the arrow next to the Network button and select **Access Point**.

**Note:** If you under the Network section in the VLAN 0 configuration, you can click VLAN 0 at the top and click on Access Point in the drop-down list.

- Review the settings, click **Save** when finished.

Access Point	<input type="radio"/> Enable	<input checked="" type="radio"/> Disable
ESSID	<input type="text" value="TRENDnet740_0"/>	
SSID Visibility	<input checked="" type="radio"/> Enable	<input type="radio"/> Disable
Client Isolation	<input checked="" type="radio"/> Enable	<input type="radio"/> Disable
Connection Limit	<input type="radio"/> Enable	<input checked="" type="radio"/> Disable
User Limit	<input type="text" value="32"/>	
Authentication	<input type="text" value="Open System"/>	

- **Access Point** – Enable or Disable the wireless network interface.
- **Wireless Network Name (ESSID):** Enter the wireless name (SSID) for your wireless network. It differentiates your wireless network from others around you.
- **SSID Visibility** – Enable or disable your wireless network name from being discovered by wireless scanning or client devices. Please note that this does not disable your radio, only hides the network name.
- **Client Isolation** – When isolation is enabled, this restricts wireless client devices from communicating to each other when connected to the same wireless network providing an extra level of security. If disabled, this allows wireless client devices to communicate to each other when connected to the same wireless network.
- **Connection Limit** – The maximum number of connected wireless client devices can be set using this setting for additional control and prevention of overloading the wireless network with too many client connections. Check the Enable option, and enter the maximum number of connections in the User Limit field
- **Authentication** – Set the wireless encryption for the wireless network.
  - **Open System** – No encryption required to connect to wireless network.

- **WPA/WPA2 Personal** – Applies standard WPA or WPA2 wireless security requiring a specifically assigned passphrase to connect to the wireless network. (Passphrase: 8-63 alphanumeric characters).
- **WPA/WPA2 Enterprise** – Applies standard WPA or WPA2 wireless security requiring the use of the third party RADIUS authentication server to authenticate wireless clients connecting to the wireless network. The third party RADIUS authentication server is external to the access point and must be set up and configured separately. Once the RADIUS is properly set up on the network, the access point will forward and authentication requests to the external RADIUS server via IP address and shared secret.
- **802.1X** – This authentication method is similar to WPA/WPA2 enterprise in that it requires an external third party RADIUS authentication server. Standard WPA/WPA2 encryption is not applied, only the requirement for RADIUS.

#### MAC Address Filter

System > VLAN Setup > VLAN # > MAC Filter

This feature will add another layer of security by restricting access by WiFi MAC address. You can specify either which MAC addresses to allow or which MAC addresses to deny access.

- Log into your access point management page (see "[Access your access point management page](#)" on page 28).
- Click **System** and click on **VLAN Setup**.
- For the first entry in the list VLAN #0, under the **Action** column, click the arrow next to the Network button and select **MAC Filter**.
 

**Note:** First, decide whether you would like to specify only MAC addresses allow or MAC addresses to deny and add them to the list. It is easier to specify only MAC addresses to allow and deny all other since the MAC addresses are known.
- In the **Add MAC Address** section, enter the first MAC address to allow or deny in the MAC address field in the following format (XX:XX:XX:XX:XX:XX). Click **Add** to add the MAC address to the MAC address list. Repeat to add additional MAC addresses.

5. In the **MAC Rules**, select the rule action.

**Only Allow List MAC** – This rule only allows listed MAC addresses to connect and denies all others.

**Only Deny List MAC** – This rule denies all listed MAC addresses and allows all others to connect.

## DHCP Server

*System > VLAN Setup > VLAN # > DHCP Server*

This feature will allow to distribute IP address automatically on the selected interface. Typically, your network router will already be automatically distribute IP address settings via DHCP.

1. Log into your access point management page (see "[Access your access point management page](#)" on page 28).
2. Click **System** and click on **VLAN Setup**.
3. For the first entry in the list VLAN #0, under the **Action** column, click the arrow next to the Network button and select **DHCP Server**. Review the settings below and click **Save** when completing the changes.

- **Mode** – Enable or Disable the DHCP service.

- **Start IP:** Enter the first IP address of the IP address range/pool to distribute to DHCP client devices. (ex. 192.168.10.101)
- **End IP:** Enter the last IP address of the IP address range/pool to distribute to DHCP client devices. (ex. 192.168.10.199)
- **Netmask:** Enter the subnet mask to distribute to DHCP client devices. (ex. 255.255.255.0)
- **Gateway:** Enter the default gateway IP address to distribute to DHCP client devices. (ex. 192.168.10.1)
- **DNS1 IP:** Enter the IP address of the primary DNS server to distribute to DHCP client devices.
- **DNS2 IP:** Enter the IP address of the secondary DNS server to distribute to DHCP client devices.
- **WINS IP:** Enter the IP address of the WINS (Windows Internet Name Service) server to distribute to DHCP client devices. Typically this is used on a Windows network to allow the resolution of computer and device names.
- **Domain:** Enter the domain name to distribute to DHCP client devices. (ex. *trendnet.com*)
- **Lease Time:** Enter the time in seconds how long DHCP client devices will retain their settings assigned by the DHCP service before expiration. Upon expiration, DHCP client devices will initiate new requests for DHCP client settings.

**DHCP Setup**

**Start IP**

**End IP**

**Netmask**

**Gateway**

**DNS1 IP**

**DNS2 IP**

**WINS IP**

**Domain**

**Lease Time**

After the DHCP server settings have been configured and changes have been applied, dynamic DHCP client leases will appear in the **DHCP Client List** table.

**DHCP Client List**

#	IP Address	MAC Address	Expired	Action
-	-	-	-	-

**DHCP Reservation/Static Lease**

System > VLAN Setup > VLAN # > DHCP Server

From the DHCP IP address range, you can set a permanent IP address assignment to a specific client device MAC address so the IP address assignment will not change.

1. Log into your access point management page (see "[Access your access point management page](#)" on page 28).
2. Click **System** and click on **VLAN Setup**.
3. For the first entry in the list VLAN #0, under the **Action** column, click the arrow next to the Network button and select **DHCP Server**. In the Static Lease IP Setup section, please review the settings below and click **Save** when completing the changes.
  - **Comment:** Add a comment or name to help easily identify the device or purpose of the DHCP static IP lease/reservation.
  - **IP Address:** Enter the IP address from the DHCP server IP address range/pool to permanently assign. (ex. 192.168.10.20)
  - **MAC Address:** Enter the MAC address of the client device to assign the permanent lease in the example format provided and click **Add** to add the static IP lease to the list. (ex. 00:11:22:AA:BB:CC). Repeat to add additional static IP leases.

**Static Lease IP Setup**

**Comment**

**IP Address**

**MAC Address**  **Add**

**Static Lease IP List**

#	Comment	IP Address	MAC Address	Action
-	-	-	-	-

**802.11r/802.11k Fast Roaming**

System > VLAN Setup > VLAN # > 802.11r Fast Roaming

When the APs are configured with the same SSID and encryption, these settings enable WiFi clients to seamlessly roam between APs with minimal or no downtime during transitions. For these fast roaming functions to work properly, the WiFi clients must also support 802.11r and 802.11k. 802.11r speeds up WiFi client roaming and transition by pre-authentication eliminating the need for the client to pre-authenticate at every access point. 802.11k enhances roaming efficiency by providing information (signal strength & utilization) to WiFi clients about APs in the network allowing the clients choose the next AP to connect to or transition.

**Note:** Please note that fast roaming features require the WiFi clients to also support 802.11r and 802.11k. Please check your wireless client device or adapter specifications.

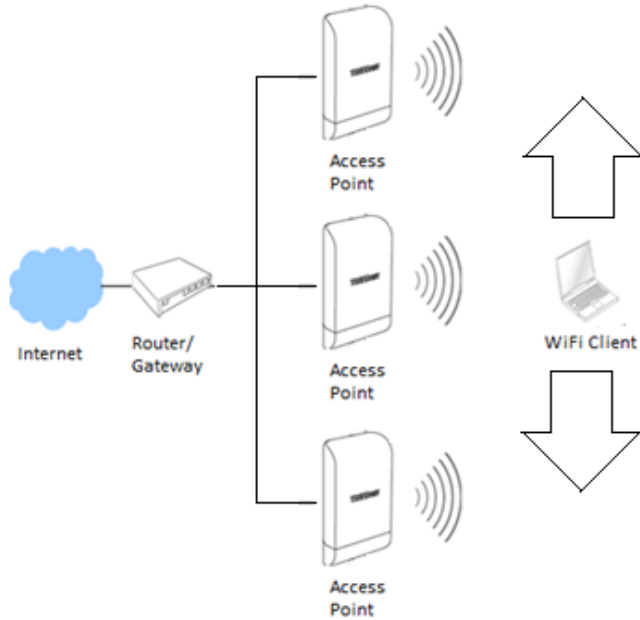

1. Log into your access point management page (see "[Access your access point management page](#)" on page 28).

2. Click **System** and click on **VLAN Setup**.

3. For the first entry in the list VLAN #0, under the **Action** column, click the arrow next to the Network button and select **802.11r Fast Roaming**. In the Static Lease IP Setup section, please review the settings below and click **Save** when completing the changes.

- **Fast Roaming:** Enable or Disable the fast roaming features.

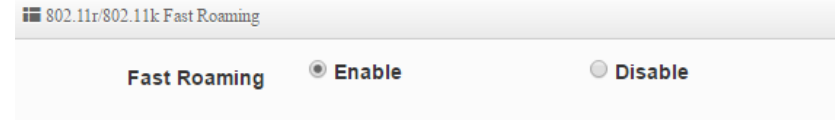

- **Mobility Domain:** The identifier used to indicate a domain or group of access points. Enter the ID (2 octets) as a 4-digit hexadecimal string. (Hex Format: 0-9 and A-F) (ex. a1b2)  
**Note:** When enabling roaming, the domain ID must be the same on all APs in same wireless roaming group.
- **Reassoc Deadline:** Re-association deadline time units (TU2 / 1.024 ms; range 1000 – 65535).
- **R0/NAS Identifier:** PMK-R0 Key Holder Identifier. When using IEEE 802.11R, this value must be configured and must be between 1 to 48 octets long alphanumeric characters. (ex. ap.example.com) This value will need to be entered in other APs in the same mobility domain as the R0 Key Holder NAS identifier.
- **R1 Identifier:** PMK-R1 Key Holder ID (6 octets) as a 12-digit hexadecimal string. (Hex Format: 0-9 and A-F) (ex. 000102030405)
- **R1 Push:** Enables or disables the R1 key to automatically be sent. Enable this setting if you are only configuring roaming between APs without a wireless controller.

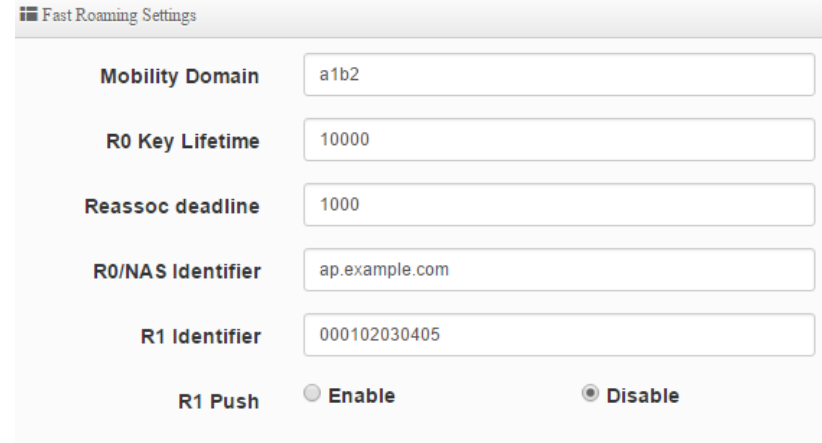

In the R0 Key Holders field, you will need to enter in all other APs in the Mobility Domain for roaming. To add an AP, enter the MAC address, NAS identifier, and 128-bit key (26 hexadecimal characters, Hex Format: 0-9 and A-F)

**R0 Key holders**

<b>MAC Address</b>	Destination MAC Address
<b>NAS Identifier</b>	(1-48 octets)
<b>128-bit Key</b>	128-bit key as hex string <span style="float: right;"><b>Add</b></span>

- **MAC Address:** Enter the WiFi MAC address of the remote AP to add.
- **NAS Identifier:** Enter the NAS identifier of the remote AP.
- **128-bit Key:** Enter the 128-bit key of the remote AP. (26 hexadecimal characters, Hex Format: 0-9 and A-F)

In the R1 Key Holders field, enter a unified set of R1 Key Holder information, enter the MAC address, NAS identifier, and 128-bit key (26 hexadecimal characters, Hex Format: 0-9 and A-F)

**R1 Key Holders**

<b>MAC Address</b>	Destination MAC Address
<b>R1 Identifier</b>	R1 Identifier
<b>128-bit Key</b>	128-bit key as hex string <span style="float: right;"><b>Add</b></span>

- **MAC Address:** Enter the main roaming device MAC address.
- **R1 Identifier:** Enter the Shared Identifier.
- **128-bit Key:** Enter the 128-bit key. (26 hexadecimal characters, Hex Format: 0-9 and A-F)

### Additional Wireless Settings

*Wireless > Radio 0 Basic Setup*

1. Log into your access point management page (see "[Access your access point management page](#)" on page 28).
2. Click **Wireless** and click on **Radio 0 Basic Setup**.
3. Review the settings, click **Save** when finished.

<b>MAC Address</b>	00:22:aa:00:12:0b
<b>Country</b>	United States ▼
<b>Band Mode</b>	802.11b/g/n ▼
<b>Auto Channel</b>	<input type="radio"/> Enable <input checked="" type="radio"/> Disable
<b>Channel</b>	1 (2412 Mhz) ▼
<b>Tx Power</b>	Level 9 ▼
<b>Slot Time</b>	9 <span style="float: right;"><b>Distance</b></span>
<b>ACK Timeout</b>	64

- **MAC Address:** Displays the WiFi MAC address of the access point.
- **Country** – Displays the current country/region the access point is set to currently operate.
- **Band Mode** – Allows you to set which wireless client devices are able to connect to the access point. 802.11b/g/n, 802.11b/g. Wireless client devices that do not support the 802.11 mode specified will not be able to connect to the access point.
- **Auto Channel** – Enables your access point to automatically scan for which wireless channel to operate automatically. Please note for WDS bridging only, the wireless channel must match on both sides of the wireless WDS bridge link.

- **Channel** – If Auto Channel is disabled, select the wireless channel the access point will operate.
- **Tx Power** – You can adjust the wireless output power of the access point to achieve the appropriate wireless coverage. It is recommended to keep the default setting, level 9.
- **Slot Time:** By default, the slot time is set to **9 microsecond**. Slot time is the amount of time a device waits after a collision before retransmitting a packet. Reducing the slot time decreases the overall back-off, which increases throughput. Back-off, which is a multiple of the slot time, is the random length of time a station waits before sending a packet on the LAN. For a sender and receiver own right of the channel the shorter slot time help manage shorter wait time to re-transmit from collision because of hidden wireless clients or other causes. When collision sources can be removed sooner and other senders attempting to send are listening the channel (CSMA/CA) the owner of the channel should continue ownership and finish their transmission and release the channel. Then, following ownership of the channel will be sooner for the new pair due to shorter slot time. However, when long duration of existing collision sources and shorter slot time exist the owners might experience subsequent collisions. When adjustment to longer slot time can't improve performance then RTS/CTS could supplement and help improve performance. Additionally, if you are encountering wireless connection issues specifically with wireless WDS bridge linked connectivity, you can click distance and enter the distance in m (meters) and slot time will be automatically adjusted accordingly. It is recommended to keep the default setting.
- **ACK Timeout:** ACK timeout is in the range of **1~255** and set in unit of *microsecond*. The default value is **85** microsecond. All data transmission in 802.11b/g request an "Acknowledgement" (ACK) send by receiving radio. The transmitter will resend the original packet if correspondent ACK failed to arrive within specific time interval, also refer to as "ACK Timeout".  
ACK Timeout is adjustable due to the fact that distance between two radio links may vary in different deployment. ACK Timeout makes significant influence in performance of long distance radio link. If ACK Timeout is set too short, transmitter will start to "Resend" packet before ACK is received, and throughputs become low due to excessively high re-transmission. ACK Timeout is best determined by distance between the radios, data rate of average environment. The Timeout value is calculated based on round-trip time of packet with a little tolerance, So, if experiencing re-transmissions or poor performance the ACK Timeout could be made longer to accommodate.

- **TX/RX Stream:** This will allow you to set the number of wireless streams. By default, this is set to 2T2R (2 Transmit / 2 Receive) streams approximately 300Mbps operating @ 64 QAM. If using 1T1R (1 Transmit / 1 Receive) streams the maximum possible speed is approximately 150Mbps.
- **Channel Width:** Select the appropriate channel width for your wireless network. This setting only applies to 802.11n. For greater 802.11n performance, select **20/40MHz (Auto)** (Options: 20MHz or 20/40MHz (Auto)). It is recommended to use the default channel bandwidth settings.  
**Note:** Please note that this setting may provide more stability than the higher channel bandwidth settings such as 20/40MHz (Auto) for connectivity in busy wireless environments where there are several wireless networks in the area.
  - **20 MHz** – This mode operates using a single 20MHz channel for wireless devices connecting at 802.11n on both 2.4GHz and 5GHz. This setting may provide more stability than 20/40MHz (Auto) for connectivity in busy wireless environments where there are several neighboring wireless networks in the area.
  - **20/40MHz (Auto)** –When 20/40MHz (Auto) is active, this mode is capable of providing higher performance only if the wireless devices support the channel bandwidth settings. Enabling 20/40MHz (Auto)

typically results in substantial performance increases when connecting an 802.11n client.

- **Short GI** – Short GI standard for short guard interval. Enabling this setting may increase wireless throughput in less busy wireless environments by decreasing the standard guard interval time to ensure distinct transmissions do not interfere with each other. Although enabling this setting may slightly increase wireless throughput, it may also increase errors depending on the wireless environment.
- **Aggregation** – This setting may increase wireless throughput by sending additional frames in a single transmission. This maximum number of aggregation frames and total aggregation size can also be set for single transmission.

### Advanced Wireless Settings

*Wireless > Advanced Setup*

1. Log into your access point management page (see "[Access your access point management page](#)" on page 28).
2. Click **Wireless** and click on **Radio 0 Basic Setup**.
3. Review the settings, click **Save** when finished.

Beacon Interval

100

DTIM Interval

1

Fragment  
Threshold

2346

RTS Threshold

2346

Short Preamble

Enable

Disable

IGMP Snooping

Enable

Disable

Greenfield

Enable

Disable

- **Beacon Interval:** Beacon Interval is in the range of **20~1024** and set in unit of *millisecond*. The default value is **100** msec.

Access Point (AP) in IEEE 802.11 will send out a special approximated 50-byte frame, called "Beacon". Beacon is broadcast to all the stations, provides the basic information of AP such as SSID, channel, encryption keys, signal strength, time stamp, support data rate.

All the radio stations received beacon recognizes the existence of such AP, and may proceed next actions if the information from AP matches the requirement. Beacon is sent on a periodic basis, the time interval can be adjusted.

By increasing the beacon interval, you can reduce the number of beacons and associated overhead, but that will likely delay the association and roaming process because stations scanning for available access points may miss the beacons. You can decrease the beacon interval, which increases the rate of beacons. This will make the association and roaming process very responsive; however, the network will incur additional overhead and throughput will go down.

- **DTIM Interval:** The DTIM interval is in the range of **1~255**. The default is **1**. DTIM is defined as *Delivery Traffic Indication Message*. It is used to notify the



wireless stations, which support power saving mode, when to wake up to receive multicast frame. DTIM is necessary and critical in wireless environment as a mechanism to fulfill power-saving synchronization. A DTIM interval is a count of the number of beacon frames that must occur before the access point sends the buffered multicast frames. For instance, if DTIM Interval is set to 3, then the Wi-Fi clients will expect to receive a multicast frame after receiving three Beacon frame. The higher DTIM interval will help power saving and possibly decrease wireless throughput in multicast applications.

- **Fragment Threshold:** The default range for the fragment threshold is 256~2346 bytes. The default is 2346 byte. This setting is used to specify the maximum size for a data packet before being fragmented into multiple data packets.
- **RTS Threshold:** RTS Threshold is in the range of 1~2347 byte. The default is 2346 byte. The main purpose of enabling RTS by changing RTS threshold is to reduce possible collisions due to hidden wireless clients. RTS in AP will be enabled automatically if the packet size is larger than the Threshold value. By default, RTS is disabled in a normal environment supports non-jumbo frames.
- **Short Preamble:** By default, it's "Enable". To Disable is to use Long 128-bit Preamble Synchronization field. The preamble is used to signal "here is a train of data coming" to the receiver. The short preamble provides 72-bit Synchronization field to improve WLAN transmission efficiency with less overhead.
- **IGMP Snooping** – Enabling this setting identifies multicast traffic transmitted over the access point and filter accordingly to prevent multicast flooding.
- **Greenfield** – When enabled, restricts the access point to communicate only with other 802.11n devices. Other pre-802.11n clients such as 802.11b/g will be ignored.

**Wireless WMM QoS Setup**

Wireless > WMM Setup

1. Log into your access point management page (see "[Access your access point management page](#)" on page 28).
2. Click **Wireless** and click on **WMM Setup**.
3. Review the settings, click **Save** when finished.

To achieve optimal wireless performance, it is necessary to tweak advance setting per requirements properly, not necessary higher the better or lower. The administrator can change the RTS threshold and fragmentation threshold settings for the system.

WMM Parameters of Access Point					
AC Type	CWmin	CWmax	AIFS	TxOp Limit	No ACK Policy bit
AC_BE(0)	4	6	3	0	<input type="checkbox"/>
AC_BK(1)	4	10	7	0	<input type="checkbox"/>
AC_VI(2)	3	4	1	3008	<input type="checkbox"/>
AC_VO(3)	2	3	1	1504	<input type="checkbox"/>

WMM Parameters of Station					
AC Type	CWmin	CWmax	AIFS	TxOp Limit	ACM bit
AC_BE(0)	4	10	3	0	<input type="checkbox"/>
AC_BK(1)	4	10	7	0	<input type="checkbox"/>
AC_VI(2)	3	4	2	3008	<input type="checkbox"/>
AC_VO(3)	2	3	2	1504	<input type="checkbox"/>

- **WMM Parameters of Access Point** : This affects traffic flowing from the access point to the client station

Queue	Data Transmitted AP to Clients	Priority	Description
AC_BK	Background.	Low	High throughput. Bulk data that requires maximum throughput and is not time-sensitive is sent to this queue (FTP data, for example).
AC_BE	Best Effort	Medium	Medium throughput and delay. Most traditional IP data is sent to this queue
AC_VI	Video	High	Minimum delay. Time-sensitive video data is automatically sent to this queue
AC_VO	Voice	High	Time-sensitive data like VoIP and streaming media are automatically sent to this queue

Queue	Data Transmitted Clients to AP	Priority	Description
AC_BK	Background.	Low	High throughput. Bulk data that requires maximum throughput and is not time-sensitive is sent to this queue (FTP data, for example).
AC_BE	Best Effort	Medium	Medium throughput and delay. Most traditional IP data is sent to this queue
AC_VI	Video	High	Minimum delay. Time-sensitive video data is automatically sent to this queue
AC_VO	Voice	High	Time-sensitive data like VoIP and streaming media are automatically sent to this queue

Configuring QoS options consists of setting parameters on existing queues for different types of wireless traffic. You can configure different minimum and maximum wait times for the transmission of packets in each queue based on the requirements of the media being sent. Queues automatically provide minimum transmission delay for Voice, Video, multimedia, and mission critical applications, and rely on best-effort parameters for traditional IP data.

As an Example, time-sensitive Voice & Video, and multimedia are given effectively higher priority for transmission (lower wait times for channel access), while other applications and traditional IP data which are less time-sensitive but often more data-intensive are expected to tolerate longer wait times.

- **Aifsn**: The Arbitration Inter-Frame Spacing Number specifies a wait time (in milliseconds) for data frames
- **CWmin**: Minimum Contention Window. This parameter is input to the algorithm that determines the initial random back-off wait time ("window") for retry of a transmission. The value specified here in the Minimum Contention Window is the upper limit (in milliseconds) of a range from which the initial random back-off wait time is determined.
- **CWmax**: Maximum Contention Window. The value specified here in the Maximum Contention Window is the upper limit (in milliseconds) for the doubling of the random back-off value. This doubling continues until either the data frame is sent or the Maximum Contention Window size is reached. Once the Maximum Contention Window size is reached, retries will continue until a maximum number of retries allowed is reached. Valid values for the "cwmax" are 1, 3, 7, 15, 31, 63, 127, 255, 511, or 1024. The value for "cwmax" must be higher than the value for "cwmin".
- **Txop**: Transmission Opportunity is an interval of time when a WME AP has the right to initiate transmissions onto the wireless medium (WM). This value specifies (in milliseconds) the Transmission Opportunity (TXOP) for AP; that is, the interval of time when the WMM AP has the right to initiate transmissions on the wireless network.
- **ACM**: Admission Control Mandatory, ACM only takes effect on AC\_VI and AC\_VO. When you do not click Checkbox, it means that the ACM is controlled by the connecting AP. If you click Checkbox, it means that the Client is in charge.
- **AckPolicy**: Acknowledgment Policy, WMM defines two ACK policies: **Normal ACK** and **No ACK**. Click "Checkbox" indicates "No ACK"

When the no acknowledgment (No ACK) policy is used, the recipient does not acknowledge received packets during wireless packet exchange. This policy is suitable in the environment where communication quality is fine and interference

is weak. While the No ACK policy helps improve transmission efficiency, it can cause increased packet loss when communication quality deteriorates. This is because when this policy is used, a sender does not retransmit packets that have not been received by the recipient. When the Normal ACK policy is used, the recipient acknowledges each received unicast packet.

- **WMM Parameters of Station:** This affects traffic flowing from the client station to the access point.
- **Aifsn:** The Arbitration Inter-Frame Spacing Number specifies a wait time (in milliseconds) for data frames
- **CWmin:** Minimum Contention Window. This parameter is input to the algorithm that determines the initial random backoff wait time ("window") for retry of a transmission. The value specified here in the Minimum Contention Window is the upper limit (in milliseconds) of a range from which the initial random backoff wait time is determined.
- **CWmax:** Maximum Contention Window. The value specified here in the Maximum Contention Window is the upper limit (in milliseconds) for the doubling of the random backoff value. This doubling continues until either the data frame is sent or the Maximum Contention Window size is reached. Once the Maximum Contention Window size is reached, retries will continue until a maximum number of retries allowed is reached. Valid values for the "cwmax" are 1, 3, 7, 15, 31, 63, 127, 255, 511, or 1024. The value for "cwmax" must be higher than the value for "cwmin".
- **Txop:** Transmission Opportunity is an interval of time when a WME AP has the right to initiate transmissions onto the wireless medium (WM). This value specifies (in milliseconds) the Transmission Opportunity (Txop) for AP; that is, the interval of time when the WMM AP has the right to initiate transmissions on the wireless network.
- **ACM:** Admission Control Mandatory, ACM only takes effect on AC\_VI and AC\_VO. When you do not click Checkbox, it means that the ACM is controlled by the connecting AP. If you click Checkbox, it means that the Client is in charge.

Click **Save** button to save your changes. Click **Reboot** button to activate your changes. The items in this page are for AP's RF advanced settings and will be applied to **all VAPs** and **WDS Links**.

## WDS (Wireless Distribution System)

### Wireless > WDS Setup

When in AP (Access Point) mode, you can also configure the access point to establish wireless WDS bridged links at the same time (AP + WDS mode).

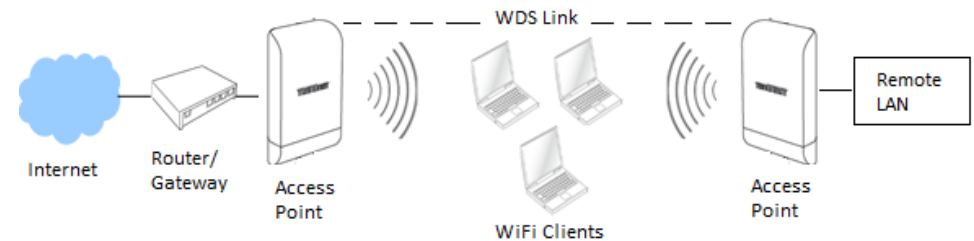

1. Log into your access point management page (see "[Access your access point management page](#)" on page 28).
2. Click **Wireless** and click on **WDS Setup**.
3. Review the settings, click **Save** when finished.

**WDS Setup**

WDS Setup  **Enable**  **Disable**

**ESSID**

**Authentication**

**PassPhrase**

- **WDS Setup** – Enable or Disable WDS functionality.
- **ESSID** – The SSID or wireless network name for WDS connections only.
- **Authentication** – Specifies the type of security used for the WDS link. None or AES. Please note this is not the same as WPA/WPA2 and can only be used for WDS connections to this access, not standard wireless client devices.

WDS Client Setup

Enable	MAC Address
<input checked="" type="checkbox"/>	<input type="text" value="00:22:aa:00:12:08"/>
<input type="checkbox"/>	<input type="text"/>
<input type="checkbox"/>	<input type="text"/>

- **WDS Client Setup** – Enter the remote access points wireless MAC addresses in the table to establish the wireless WDS link.

MAC Address

Radio 0	<input type="text" value="00:22:aa:00:12:0b"/>
---------	--

- **MAC Address** – Displays the currently managed access point wireless MAC address or BSSID.

VLAN Setup

VLAN#	Radio 0		
	Native	TAG	TAG ID
VLAN 0	<input checked="" type="radio"/>	<input type="checkbox"/>	<input type="text"/>
VLAN 1	<input type="radio"/>	<input type="checkbox"/>	<input type="text" value="101"/>
VLAN 2	<input type="radio"/>	<input type="checkbox"/>	<input type="text" value="102"/>

- **VLAN Setup** – Allows you to configure VLANs that will communicate across the wireless WDS link. See the example diagrams below.

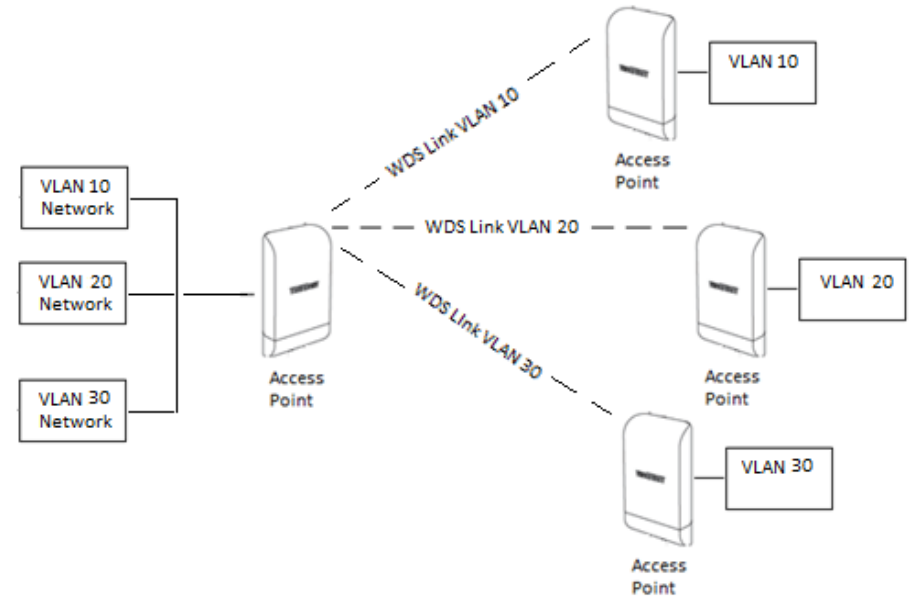
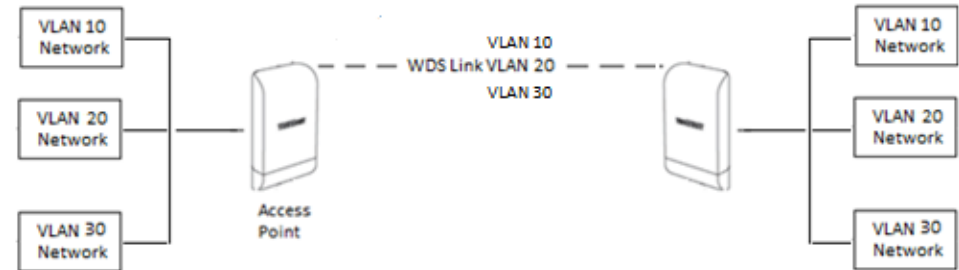

Radio0 Client

MAC Address	Rntr(RX/TX)	RSSI
00:22:aa:00:12:08	0Mb / 19Mb	-1

- **WDS Status** – Displays information about currently established wireless WDS links to the managed access point.

**Authentication/Captive Portal***System > Authentication > VLAN #*

On each VLAN interface/SSID, guest authentication can be used using either the local user database, RADIUS, or OAuth 2.0 Authentication Server (ex. Google, Facebook, etc.)

Additionally, you can use the built-in page template for captive portal/wall garden user login or upload your own customized page.

**Authentication***System > Authentication > VLAN # > Authentication*

This section allows you to configure the user name and password type authentication method through either the local user database or external RADIUS server.

1. Log into your access point management page (see "[Access your access point management page](#)" on page 28).
2. Click **System**, click on **Authentication**, and in the first entry VLAN 0, in the **Action** column, and click on **Authentication**. Review the settings and click **Save** to apply the changes.

- **Authentication** - Enable or disable the authentication function on the interface.

 Authentication

Authentication

 Enable Disable

- **Multiple Login** – Check the option to allow multiple logins concurrently with the same user.
- **Login Timeout** – Enter the idle timeout period before automatically logging out users in minutes.
- **Redirect URL** – Enter the URL of the web page to automatically redirect users after successful login.
- **Login URL** – Enter the URL of the login page for users.
- **Authentication Log** – Enable or disable authentication logging.
- **Session Log** – Enable or disable session logging.

 Authentication Setup

Multiple Login



3

User(s)

Login Timeout

10

Minutes

Redirect URL

http://www.google.com

Login URL

domain0.url

Authentication Log



Enable



Disable

Session Log



Enable



Disable

There are 2 methods to authenticate users you can choose, Local User or RADIUS. If you are running your own external RADIUS server for authentication, you can choose the RADIUS option and configure server settings accordingly.

**Local User** – Enable or disable local user authentication. This will authenticate users through the internal local user database.

 Local User Setup

Local User



Enable



Disable

Display Name

Local User

If using Local User, create your user accounts **System > Authentication > VLAN # > Local User**.

**RADIUS Setup** – Enable or disable RADIUS authentication. This will authenticate users through the external RADIUS authentication server and require that you have already a server set up manually.

- **Primary Server IP** – Enter the IP address of the primary RADIUS.
- **Secondary Server IP** – If you have a secondary or backup RADIUS server, enter the IP address.
- **Authentication Port** – Enter the authentication port number used by your RADIUS server for authentication requests. Typically, the default RADIUS server port is 1812.
- **Accounting Service** – If your RADIUS server also has accounting enabled, check the option and enter the accounting port. Typically, the default RADIUS server account port is 1813.
- **Authentication** – Select the authentication type used by your RADIUS server for user authentication. Typically, CHAP is used since it is more secure than PAP.
- **Secret Key** – Enter the shared secret required by your RADIUS server.

☰ RADIUS Setup

Radius
 Enable
 Disable

Display Name

Primary Server IP

Secondary Server IP

Authentication Port

Port

Accounting Service

Port

Authentication Type
 PAP
 CHAP

Secret Key

If you have bandwidth restriction limits for your guest users, you can specify those limits per user and total allocated bandwidth in Kbps.

☰ Bandwidth Control

Peer Users
 Enable
 Disable

Upload

Kbps

Download

Kbps

Total
 Enable
 Disable

Upload

Kbps

Download

Kbps

### Guest Authentication

*System > Authentication > VLAN # > Guest*

This section allows you configure the guest authentication function.

1. Log into your access point management page (see "[Access your access point management page](#)" on page 28).
2. Click **System**, click on **Authentication**, and in the first entry VLAN 0, in the **Action** column, and click on drop-down list and click **Guest**. Review the settings and click **Save** to apply the changes.

- **Service** – Enable or disable the guest authentication function.
- **Login Type:**
  - **One Time** – Allows a single user account to be logged in only one instance.
  - **Multiple Time** – Allows a single user account to be logged in at multiple instances.
- **Count Limit** – Specifies the maximum amount of connected users at any given time. Once the maximum is reached, other users will not be able to log on until of the existing users logs out or disconnects.
- **Login Time** - Specifies the maximum amount of time users can be logged on before automatically disconnected.
- **QoS** – Allows use to specify the maximum total amount of upload and download bandwidth allowed for guest authenticated users in Kbps.

Guest

Service  Enable  Disable

Login Type  One Time  Multiple Time

Count Limit

Login Time  Minutes

QoS  Enable  Disable

Upload  Kbps

Download  Kbps

**OAuth 2.0**

System > Authentication > VLAN # > OAuth 2.0

OAuth 2.0 is an open standard for authorization for allowing users to authenticate to third-party websites using their Microsoft, Google, Facebook, Twitter accounts etc. without exposing their passwords. Additionally, these providers may allow for methods of creating a custom walled garden/splash page. By default, Google and Facebook provider entries have already been created but you may add more providers to the list.

Assuming you have the developer API account and splash page already set up with your provider.

1. Log into your access point management page (see "[Access your access point management page](#)" on page 28).
2. Click **System**, click on **Authentication**, and in the first entry VLAN 0, in the **Action** column, and click on drop-down list and click **OAuth 2.0**. Review the settings and click **Save** to apply the changes.
  - **Create New Provider** – Click this option to create a new provider if it is not listed in the table.
  - **Provider** – Enter the provider name to easily identify.
  - **Active** – Enable or disable OAuth 2.0 authorization with the provider.
  - **Client ID** – Enter the client ID used with the provider.
  - **Client Secret** – Enter the client secret or password used with the provider.
  - **Advanced** – Click the Advanced button to specify the **Scope**, **Auth URL**, **Token URL**, **User Info URL**, and **Revoke URL** used for the provider.
  - **Walled URL** – Enter in the URLs used for your walled garden with the providers and click **Add** to add them to the list.

OAuth 2.0 Provider List Create New Provider

#	Active	Provider	Action
1	Off	Google	Edit
2	Off	Facebook	Edit

## POP3 Server

System > Authentication > VLAN # > POP3

1. Log into your access point management page (see "[Access your access point management page](#)" on page 28).
2. Click **System**, click on **Authentication**, and in the first entry VLAN 0, in the **Action** column, and click on drop-down list and click **POP3 Server**. Review the settings and click **Save** to apply the changes.
  - **Service** – Enable or disable POP3.
  - **Display Name** – Enter the name displayed for the POP3 user.
  - **Host** – Enter the server domain or IP address.
  - **Port** – Enter the port used for incoming POP3 traffic. Default for POP3 is port 110.
  - **Connect Type** – Click the drop-down and select the connection type used for POP3 incoming services, none, STARTTLS, or SSL/TTL.

### POP3 Server Test

- **Email** – To test the POP3 server settings, enter the email address used to test the settings.
- **Password** – to test the POP3 server settings, enter the along with the email account used to test the settings.

#### POP3 Server

Service  **Enable**  **Disable**

#### POP3 Settings

**Display Name**

**Host**

**Port**  **Port**

**Connect Type**  ▼

#### POP3 Server Test

**EMAIL**

**Password**  **Test**



## Customize Page

System > Authentication > VLAN # > Customize Page

This section allows you to customize the captive portal login page using the default template or apply your own code.

- Log into your access point management page (see "[Access your access point management page](#)" on page 28).
- Click **System**, click on **Authentication**, and in the first entry VLAN 0, in the **Action** column, and click on drop-down list and click **Customize Page**. Review the settings and click **Save** to apply the changes.
  - Template** – Enable or disable the built-in login page template. The preview area will display a preview of the built-in login page. Disabling the template option will allow you to enter in your own code for customization.
    - Style** – Select one the predefined color schemes for the built-in page template.
    - Body Background** – Enter the HTML color code for the built-in login page background.
    - Content Background** – Enter the HTML color code for the built-in login page content area background.
    - Font Color** – Enter the HTML color code for the built-in login page font.
    - Content Width** – Enter the pixel width for the entire built-in login page.
    - AD Background** – Enter the HTML color code for the ad background.
    - AD Font Color** – Enter the HTML color code for the ad font.
  - Multiple Language** – Enable or disable multiple languages on the built-in login page. To define additional languages, go to System > Authentication > VLAN # > Language.

☰ Page Setup

**Template**     **Enable**                       **Disable**

**Multiple Language**     **Enable**                       **Disable**

☰ Page Color Setup

**Style**    Default ▾ Apply

**Body Background**    #EEEEEE

**Content Background**    #FFFFFF

**Font Color**    #333333

**Content Width**    350 px

**AD Background**    #47A747

**AD Font Color**    #FFFFFF

☰ Preview

Please sign in

Remember me

Sign in

Guest

AD1

AD2

AD3

AD4

AD5

☰ Customize HTML Source code

```

      <html>
      <head>
      <title>Hotspot</title>
      <script src="/javascripts/login.js" charset="utf-8" type="text/javascript">
      </script>
      </head>
      <body>
      <div class="container"></div>
      </body>
      </html>
    
```

Preview
Preview

**Multiple Language**

System > Authentication > VLAN # > Multiple Language

This section allows you to create additional languages when using the multiple language option for the built-in captive portal login page template.

1. Log into your access point management page (see "[Access your access point management page](#)" on page 28).
2. Click **System**, click on **Authentication**, and in the first entry VLAN 0, in the **Action** column, and click on drop-down list and click **Multiple Language**. Review the settings and click **Save** to apply the changes.
  - **Create New Language** – By default, English has already been added to the list. To create a new language, click this option and enter in the text strings for the new language. The preview window will display the current built-in login page template.

Language List <span style="float: right;">Create New Language</span>			
#	Default	Language	Action
1	★	English	Edit <span style="font-size: 0.8em;">▼</span>

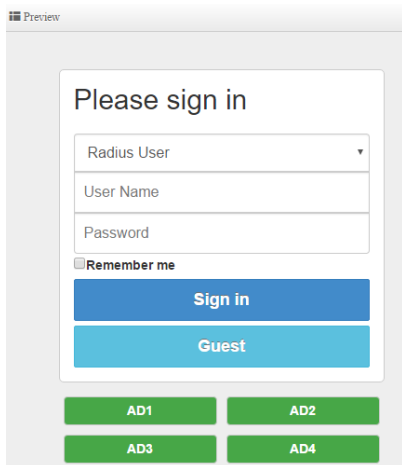

**Walled Garden**

System > Authentication > VLAN # > Walled Garden

This section can allow you to provide content such as advertisement web pages for users to access the websites listed before login and authentication.

1. Log into your access point management page (see "[Access your access point management page](#)" on page 28).
2. Click **System**, click on **Authentication**, and in the first entry VLAN 0, in the **Action** column, and click on drop-down list and click **Walled Garden**. Review the settings and click **Add** to add the entry to the walled garden list and click **Save** to apply the changes.
  - **Display Name** – Enter display name to easily identify the wall garden entry.
  - **IP Address/Domain**: Enter the IP address or domain/URL of the website to add to the walled garden.
  - **Full URL**: Enter the full URL or website name.

Walled Garden	
Display Name	<input type="text" value="(4 -32 chars)"/>
IP Address/Domain	<input type="text"/>
Full URL	<input type="text"/> <span style="float: right;">Add</span>

### Privilege Address

System > Authentication > VLAN # > Privilege Address

This section can allow you to set a privileged host addresses that may connect to your network without the need for authentication.

1. Log into your access point management page (see "[Access your access point management page](#)" on page 28).
2. Click **System**, click on **Authentication**, and in the first entry VLAN 0, in the **Action** column, and click on drop-down list and click **Privilege Address**. Review the settings and click **Add** to add the entry to the device list and click **Save** to apply the changes.
  - **Device Name** – Enter device name to easily identify device in the list.
  - **IP Address:** Enter the IP address of the privileged host device.
  - **MAC Address:** Enter the MAC address of the privileged host device.

#### Privilege Address

Device Name

(4-32 characters)

IP Address

MAC Address

Add

### Backup/Restore Authentication Profile & Customized Pages

System > Authentication > VLAN # > Profile

This section can allow you to backup/restore the authentication profile to your local drive and also backup/store customized captive portal pages.

1. Log into your access point management page (see "[Access your access point management page](#)" on page 28).
2. Click **System**, click on **Authentication**, and in the first entry VLAN 0, in the **Action** column, and click on drop-down list and click **Profile**.
  - **Download Profile Setting** – Click download to back up the authentication profile to your local drive.
  - **Upload Profile Setting** - Click **Browse** or **Choose File** to restore a previously backed up authentication profile. Click **Upload** to start the restore process.
  - **Download Customize Page** – Click download to back up the customized captive portal pages to your local drive.
  - **Upload Customize Page** - Click **Browse** or **Choose File** to restore a previously backed up captive portal page. Click **Upload** to start the restore process.

#### VLAN Profile

Download Profile Setting

Download

Upload Profile Setting

Choose File No file chosen

Upload

#### VLAN Customize Page

Download Customize Page

Download

Upload Customize Page

Choose File No file chosen

Upload

## Client Bridge + AP Mode

Client Bridge mode functions similar to that of a wireless client adapter like the one built into your notebook PC or mobile device. It wireless connects to a wireless network provided by a wireless AP or router and bridges this connection to the device Ethernet ports. Additionally, in Client Bridge mode, the device can function as an AP and create another wireless network to also bridge over it's connection from the wireless AP or router.

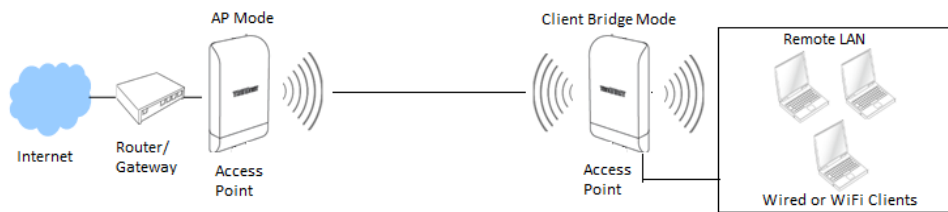

### Set the device to Client Bridge + AP mode

*System > Mode Setup*

1. Log into your access point management page (see "[Access your access point management page](#)" on page 28).
2. Click **System** and click on **Mode Setup**.
3. Select **Client Bridge + AP Mode** in the mode drop down list. Then click **Save & Reboot**.

☰ System Mode

**Mode** ClientBridge + AP Mode ▼

**Save & Reboot**

### Set the device IP address settings

*System > LAN Setup*

To set the IP address, gateway, and DNS settings, click on **System** and click on **LAN Setup**. Click **Save** when you have completed your settings.

☰ Ethernet Connection Type

**Mode**     **Static IP**     **Dynamic IP**

☰ Static IP

**IP Address** 192.168.10.100

**Netmask** 255.255.255.0

**Gateway** 192.168.10.1

☰ DNS

**Primary DNS**

**Secondary DNS**

**Connect the device to your wireless network**

*Wireless > Station Setup*

To connect to a wireless network, click on **Wireless** and click on **Station Setup**. In the AP Station List, click on **Site Survey** to scan for your wireless network.

AP Station List Site Survey

Channel	Signal	BSSID	ESSID	Security	Setup
-	-	-	-	-	-

Site Survey

Find your wireless network and click **Setup** within the entry.

Setup

The AP Station Security Settings at the top left of the page will populate with the information of the selected wireless network. If security is enabled on the wireless network, enter the WPA/WPA2 PassPhrase or WEP key in the field provided. Scroll to the bottom of the page and click **Save** when you have completed your settings and click **Reboot** in the top right menu to reboot the device and commit the changes.

AP Station Security Settings

**ESSID**

**Security Type**

**WPS Push Button** Push Button

PassPhrase Settings

**Security**

**Cipher Type**

**PassPhrase**

**Configure your wireless network settings (WLAN)**

*Wireless > AP Setup*

Verify you have established wireless bridged connectivity by attempting to communicate to the Internet or access devices or network resources.

To configure the AP wireless settings to allow other wireless clients to connect, click on **Wireless** and click on **AP Setup**. Click **Save** when you have completed your settings.

Security

**Access Point**  **Enable**  **Disable**

**ESSID**

**SSID Visibility**  **Enable**  **Disable**

**Client Isolation**  **Enable**  **Disable**

**Connection Limit**  **Enable**  **Disable**

**User Limit**

**IAPP**  **Enable**  **Disable**

**Security Type**

## WISP (CPE) + AP Mode

WISP (CPE) + AP mode is typically used to provide Internet connectivity to buildings in remote areas where telco hard wired service lines for Internet service (such as DSL or cable) are scarce or unavailable and Wireless Internet Service Providers (WISPs) are the only means of establishing Internet connectivity. In this case, the device functions similar to that of a router except the wireless interface of the AP serves the purpose of WAN (Internet) connectivity to the WISP wireless network and NAT functions performed between the wireless WAN connection to the WISP and the LAN (wired Ethernet ports LAN1/2 and AP wireless WLAN network). Additionally, DHCP server, virtual server/DMZ, MAC/IP filter functions will be available for access control similar to simple NAT router.

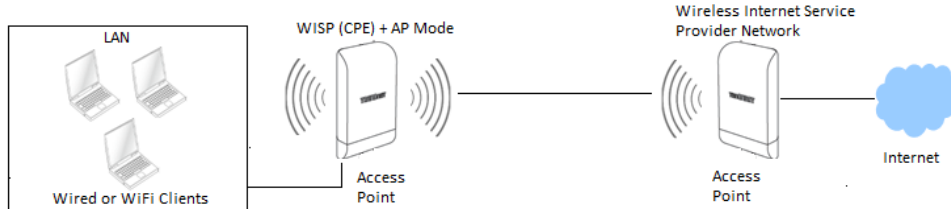

1. Log into your access point management page (see "[Access your access point management page](#)" on page 28).
2. Click **System** and click on **Mode Setup**.
3. Select **WISP (CPE) + AP Mode** in the mode drop down list. Then click **Save & Reboot**.

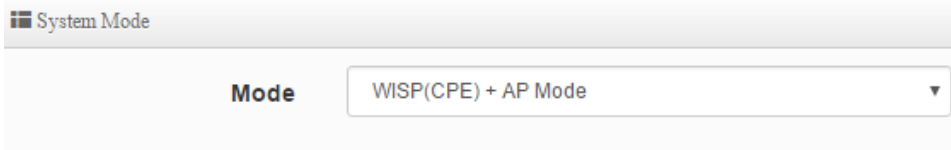

## Set the device LAN IP address settings

*System > LAN Setup*

To set the IP address, gateway, and DNS settings, click on **System** and click on **LAN Setup**. Click **Save** when you have completed your settings.

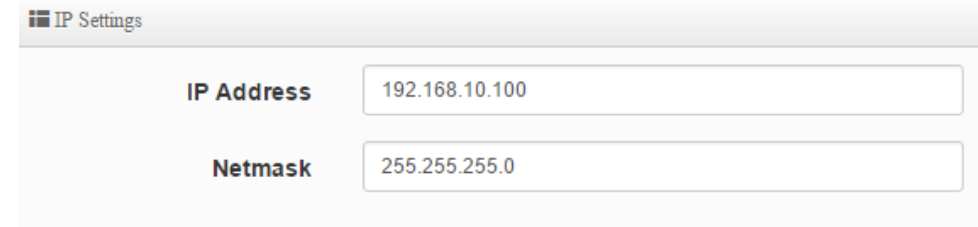

## Configure the LAN DHCP Server

*System > DHCP Setup*

To setup the DHCP Server for LAN and WLAN clients, click on **System** and click on **DHCP Setup**.

- **Mode** – Enable or Disable the DHCP service.

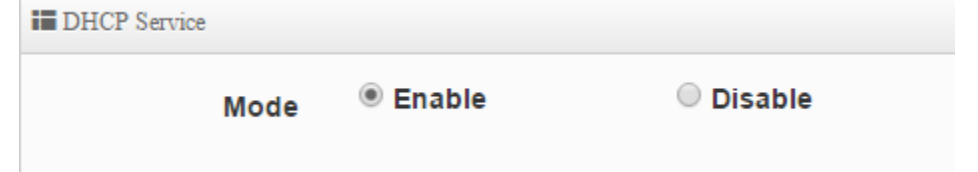

- **Start IP:** Enter the first IP address of the IP address range/pool to distribute to DHCP client devices. (ex. 192.168.10.101)
- **End IP:** Enter the last IP address of the IP address range/pool to distribute to DHCP client devices. (ex. 192.168.10.199)
- **Netmask:** Enter the subnet mask to distribute to DHCP client devices. (ex. 255.255.255.0)
- **Gateway:** Enter the default gateway IP address to distribute to DHCP client devices. This should typically be the LAN IP of the device when using WISP (CPE) + AP mode. (ex. 192.168.10.100)
- **DNS1 IP:** Enter the IP address of the primary DNS server to distribute to DHCP client devices.

- **DNS2 IP:** Enter the IP address of the secondary DNS server to distribute to DHCP client devices.
- **WINS IP:** Enter the IP address of the WINS (Windows Internet Name Service) server to distribute to DHCP client devices. Typically this is used on a Windows network to allow the resolution of computer and device names.
- **Domain:** Enter the domain name to distribute to DHCP client devices. (ex. *trendnet.com*)
- **Lease Time:** Enter the time in seconds how long DHCP client devices will retain their settings assigned by the DHCP service before expiration. Upon expiration, DHCP client devices will initiate new requests for DHCP client settings.

**DHCP Setup**

**Start IP**

**End IP**

**Netmask**

**Gateway**

**DNS1 IP**

**DNS2 IP**

**WINS IP**

**Domain**

**Lease Time**

After the DHCP server settings have been configured and changes have been applied, dynamic DHCP client leases will appear in the **DHCP Client List** table.

**DHCP Client List**

#	IP Address	MAC Address	Expired	Action
-	-	-	-	-

**DHCP Reservation/Static Lease**

System > DHCP Setup

- **Comment:** Add a comment or name to help easily identify the device or purpose of the DHCP static IP lease/reservation.
- **IP Address:** Enter the IP address from the DHCP server IP address range/pool to permanently assign. (ex. 192.168.10.20)
- **MAC Address:** Enter the MAC address of the client device to assign the permanent lease in the example format provided and click **Add** to add the static IP lease to the list. (ex. 00:11:22:AA:BB:CC). Repeat to add additional static IP leases.

**Static Lease IP Setup**

**Comment**

**IP Address**

**MAC Address**  **Add**

**Static Lease IP List**

#	Comment	IP Address	MAC Address	Action
-	-	-	-	-

**Configure WAN connection settings for WISP**

System > WAN Setup

To setup the WAN interface connection method to the WISP, click on **System** and click on **WAN Setup**. The device supports Dynamic IP, Static IP, PPPoE, and PPTP connection types. Click **Save** when you have completed the changes.

**Note:** Please check with your Wireless Internet Service Provider for the required connection settings and configure them accordingly.

- **Static IP** – Your WISP requires the IP address, Subnet Mask, Default Gateway, and DNS Server IP address settings to be manually entered and statically assigned. If required by your WISP, specify the MAC address for this interface.
- **Dynamic** – Your WISP will automatically provide you the IP address, Subnet Mask, Default Gateway, and DNS Server IP address settings. . If required by your WISP, specify the MAC address for this interface.
- **PPPoE (Point-to-Point Protocol over Ethernet)**– Your WISP requires a specifically assigned user name and password for authentication in order to establish connectivity.
- **PPTP (Point-to-Point Tunneling Procotol)** - Your WISP requires a specifically assigned user name and password for authentication in order to establish connectivity similar to PPPoE but a different type of tunneling technology.

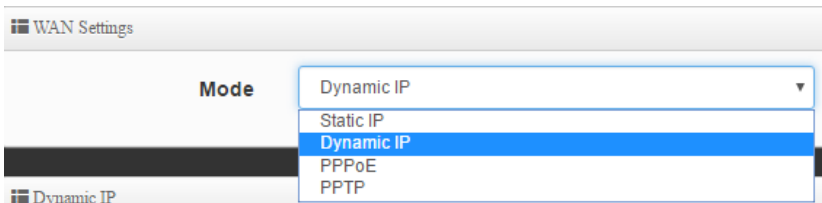

**Connect to your WISP (Wireless Internet Service Provider)**

Wireless > Station Setup

To connect to your WISP wireless network to establish Internet connectivity, click on **Wireless** and click on **Station Setup**. In the AP Station List, click on **Site Survey** to scan for your wireless network.

AP Station List						Site Survey
Channel	Signal	BSSID	ESSID	Security	Setup	
-	-	-	-	-	-	-



Find your wireless network and click **Setup** within the entry.



The AP Station Security Settings at the top left of the page will populate with the information of the selected wireless network. If security is enabled on the wireless network, enter the WPA/WPA2 PassPhrase or WEP key in the field provided. Scroll to the bottom of the page and click **Save** when you have completed your settings and click **Reboot** in the top right menu to reboot the device and commit the changes.

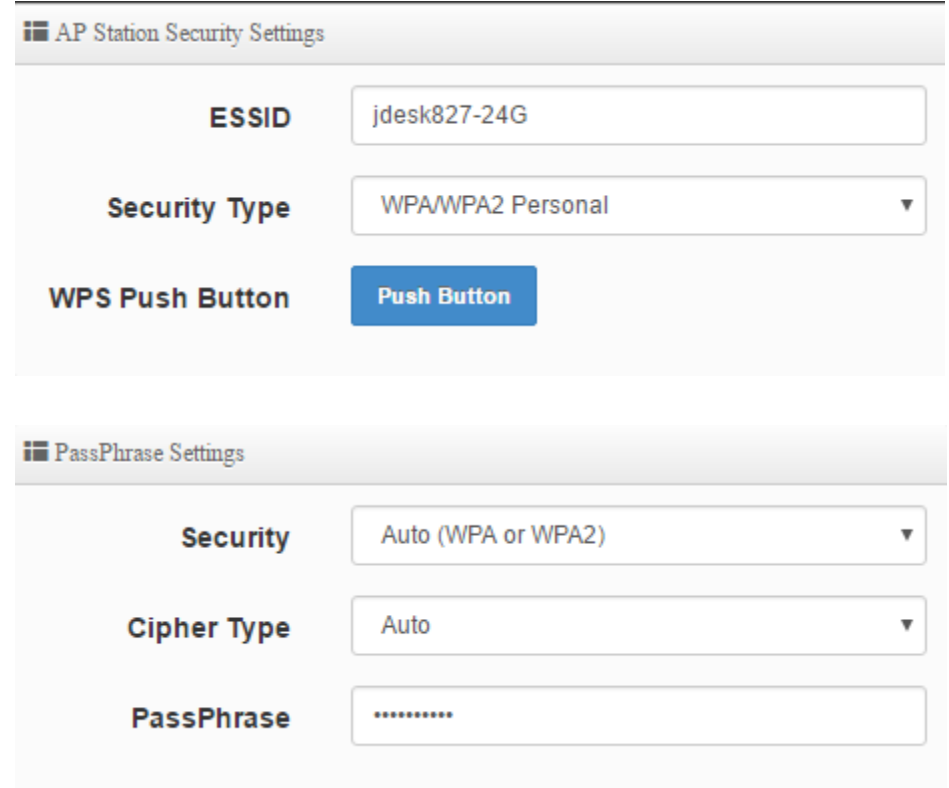



Verify you have established wireless connectivity by attempting to communicate to the Internet.

To configure the AP wireless settings to allow other wireless clients to connect, click on **Wireless** and click on **AP Setup**. Click **Save** when you have completed your settings.

**Security**

**Access Point**  **Enable**  **Disable**

**ESSID**

**SSID Visibility**  **Enable**  **Disable**

**Client Isolation**  **Enable**  **Disable**

**Connection Limit**  **Enable**  **Disable**

**User Limit**

**IAPP**  **Enable**  **Disable**

**Security Type**

### DMZ (Demilitarized Zone)

*Advance > DMZ*

You may want to expose a specific computer or device on your network to the Internet to allow anyone to access it. The DMZ (Demilitarized Zone) feature that makes all the ports and services available on the WAN/Internet side and forwards them to a single LAN IP address (computer or network device) on your network. The DMZ feature is an easy way of allowing access from the Internet however, it is a very **insecure** technology and will open local area network to greater threats from Internet attacks.

It is strongly recommended to use **Virtual Server** to allow access to your computers or network devices from the Internet.

**Note:** Make the computer or network device (for which you are establishing a DMZ link) has a static IP address or static DHCP Lease.

1. Log into your access point management page (see "[Access your access point management page](#)" on page 28).

2. Click **Advance** and click on **DMZ**.

3. Review the settings below. Click **Save** when completed.

- **Automatic Assignment** – This option allows you to assign only one DMZ host and forward all traffic requests received on the WAN side to a single LAN IP address.
  - **Internal IP Address** – Enter the LAN IP address to set as the DMZ host to forward all traffic.

**Automatic Assignment Setup**

**Internal IP Address**

- **Static Assignment** – If you have multiple WAN static IP addresses assigned by your Internet provider, this option allows you to assign multiple DMZ hosts and map them to specific static public/external IP addresses.
  - **External IP Address** – Enter the external public static IP address to map to the internal LAN IP address.
  - **Internal IP Address** – Enter the LAN IP address to set as the DMZ host to forward all traffic.

**Static Assignment Setup**

**External IP Address**

**Internal IP Address**

**IP Filter***Advance > IP Filter*

The IP filter function allows or denies services (or TCP/UDP ports or ICMP) based on source and destination IP address.

1. Log into your access point management page (see "[Access your access point management page](#)" on page 28).
2. Click **Advance** and click on **IP Filter**.
3. In the first IP filter rule entry in the list. Click **Edit**.



4. Review the settings below. Click **Save** when completed.
  - **Active** – Enable or disable the IP Filter rule.
  - **Comment** – Enter a name for the rule so it can easily be identified.
  - **Policy:**
    - **Deny** – This option blocks the port/protocol specified in the rule between source and destination IP address.
    - **Pass** – This option allows the port/protocol specified in the rule between source and destination IP address.
  - **In/Out** – Specify the traffic direction to apply the filter. **In** means ingress or inbound. **Out** means egress or outbound.
  - **Protocol** – Specify the port/protocol to deny or allow.
    - **ALL** – Specifies all TCP/UDP ports and ICMP traffic.
    - **TCP** – Specifies TCP protocol only.
    - **UDP** – Specifies UDP protocol only.
    - **ICMP** – Specifies ICMP traffic only.
  - **Source Address/Mask** – Enter the source IP address/Subnet Mask (CIDR). (ex. 192.168.10.15/32 specifies only IP address 192.168.10.15, Any: 0.0.0.0/0)
  - **Source Port** – Enter the source port number to apply the filter. (ex. Port Range: 1:65535)
  - **Destination Address/Mask** – Enter the destination IP address/Subnet Mask (CIDR). (ex. 10.10.10.30/32)
  - **Destination Port** – Enter the destination port number to apply the filter. (ex. Port

Range: 1:65535)

- **Listen** – Enable or disable filtering only TCP packet that contain the SYN flag. (TCP only).
- **Interface** – Choose the interface the IP filter applies, LAN or WAN.
- **Schedule** – You can specify a schedule under Advance > Time Policy when IP filter rule is active.

**MAC Filter***Advance > MAC Filter*

The MAC Filter function allows or denies traffic based on device MAC addresses.

1. Log into your access point management page (see "[Access your access point management page](#)" on page 28).

2. Click **Advance** and click on **MAC Filter**.

3. Choose the **Mode**.

- **Deny** – Denies traffic from all specified MAC addresses in the list and allows all others. (Blacklist)
- **Allow** – Allows traffic from all specified MAC addresses in the list and denies all others. (Whitelist)

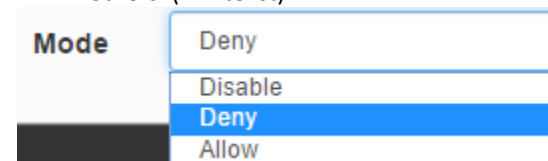

4. In the MAC Filter List, review the settings below and click **Save** to apply changes.

- **Active** – Check this option to enable the entry.
- **Comment** – Enter a name for the rule so it can easily be identified.
- **MAC Address** – Enter the MAC address to deny or allow. (00:11:22:AA:BB:CC)
- **Policy** – You can specify a schedule under Advance > Time Policy when the MAC filter rule is active.

MAC Filter List				
#	Active	Comment	MAC Address	Policy
1	<input type="checkbox"/>			Always Run

## Virtual Server

Advance > Virtual Server

Virtual Server (also called port forwarding) allows you to define specific ports (used or required by a specific application) and forward them to a single IP address (a computer or device) on your network. Using this feature is more secure compared to using DMZ in which DMZ forwards all ports instead of only specific ports used by an application. An example would be forwarding a port to an IP camera (TRENDnet IP cameras default to HTTP TCP port 80 for remote access web requests) on your network to be able to view it over the Internet.

1. Log into your access point management page (see "[Access your access point management page](#)" on page 28).
2. Click **Advance** and click on **Virtual Server**.
3. In the first Virtual Server entry in the list. Click **Edit**.

Edit

4. Review the settings and click **Save** when changes are completed.
  - **Active** – Enable or disable the virtual server.
  - **Comment** – Enter a name for the virtual server so it can easily be identified.
  - **Protocol** – Select the protocol required for your device. **TCP** or **UDP**.
  - **Public Port** – Enter the port number used to access the device from the Internet.
  - **Private IP Address** - Enter the IP address of the device to forward the port (e.g. *192.168.10.101*).
  - **Private Port** – Enter the port number required by your device. Refer to the connecting device's documentation for reference to the network port(s) required.
 

**Note:** *The Public Port can be assigned a different port number than the Private Port (also known as port redirection), however it is recommended to use the same port number for both settings. Please refer to the device documentation to determine which ports and protocols are required. It is recommended to assign a static IP address to the device or use Static IP Reservation to ensure the IP address of the device does not change.*
  - **Schedule** – You can specify a schedule under Advance > Time Policy when Virtual Server is active.

## Access Control

Advance > Access Control

The Access Control function can block TCP/UDP ports and ICMP traffic based on MAC address and/or IP address but also includes content filtering functions such as URL blocking, Keyword blocking, and also blocking specific applications. (Listed applications only)

1. Log into your access point management page (see "[Access your access point management page](#)" on page 28).
2. Click **Advance** and click on **Access Control**.
3. In the first Access Control entry in the list. Click **Edit**.

Edit

4. Review the settings and click **Save** when changes are completed.
  - **Active** – Enable or disable the access control rule.
  - **Comment** – Enter a name for the access control rule it can easily be identified.
  - **Protocol:**
    - **ANY** – Block TCP, UDP, and ICMP.
    - **TCP** – Block TCP protocol only.
    - **UDP** – Block UDP protocol only.
    - **ICMP** – Block ICMP traffic only.
    - **Content Filter** – Block web content based on Keyword. Specify the keywords in the Keyword field and click **Add** to add them to the list.
    - **Application** – Block applications specified in the predefined list. Select specified applications to block in the application drop-down list.
    - **Domain Filter** – Block specific web pages. (HTTP only). Specify the URLs/Domains to block in the Domain field and click **Add** to add them to the list.
  - **Schedule** - You can specify a schedule under Advance > Time Policy when the Access Control rule is active.

**Access Control Rules**

Active  **Enable**  **Disable**

Comment

Protocol

Schedule

- ANY
- TCP
- UDP
- ICMP
- Content Filter
- Application
- Domain Filter

**MAC Address Setup**

- **MAC Address** – Enter the device MAC address to apply the access control rule. (ex. 00:11:22:AA:BB:CC) and click **Add** to add it to the list. You can apply the rule to multiple MAC addresses.

**MAC Address Setup**

MAC Address  **Add**

- **IP Address Setup**
  - **Local IP Address** – Enter the IP address range to apply the rule.
  - **Local Port** – Enter the local port number.
  - **Destination IP Address** – Enter the destination IP address to apply the rule.
  - **Destination Port** – Enter the destination port number.

**IP Address Setup**

Local IP Address  -

Local Port

Destination IP Address  -

Destination Port

### Time Policy / Schedule

*Advance > Time Policy*

For additional security control, you can create schedules to specify a time period when a feature should be activated or deactivated. Before you use the scheduling feature, ensure that your device/system time is configured correctly under System > Time Server.

1. Log into your access point management page (see "[Access your access point management page](#)" on page 28).
2. Click **Advance** and click on **Time Policy**.
3. In the first Time Policy entry in the list. Click **Edit**.

**Edit**

4. Review the settings and click **Save** when changes are completed.
  - **Comment** – Enter a name for the time policy so it can be easily identified.
  - **Mode:**
    - **On Schedule:** For the rule used, the schedule will be activated during the time period defined in the schedule and deactivated any time period outside of the defined schedule.

- **Out of Schedule:** For the rule used, the schedule will be deactivated during the time period defined in the schedule and activated any time period outside of the defined schedule.

The screenshot shows the 'Time Policy Rules' configuration interface. It includes a 'Comment' field with the text 'Policy 1'. Below the comment field, there is a 'Mode' section with two radio button options: 'On Schedule' (which is selected) and 'Out Of Schedule'.

In the Policy List, click **Create New Policy**.



- **Days of Week** – Tick the days to apply to the time policy.
- **Start Time** – Define the start time for the time policy. (24-hr format)
- **End Time** – Define the end time for the time policy. (24-hr format)

The screenshot shows the 'Time Policy Rules' configuration interface for selecting days and times. Under the 'Day of Week' section, checkboxes are present for Sun, Mon, Tue, Wed, Thu, and Sat, all of which are checked. Below this, there are two columns of time selection. The first column has 'Start Time' and 'End Time' labels, each followed by a dropdown menu. The second column has two dropdown menus for selecting the hour and minute. The 'Start Time' dropdown is set to '00' and the 'End Time' dropdown is set to '23'. The two hour/minute dropdowns are both set to '00'.

## Router Mode

Router Mode functions as a wireless NAT router. LAN2 functions as the primary LAN interface and LAN1 functions as the WAN interface. VLANs are configurable on the LAN side and access control functions such as DMZ/Virtual Server, and IP/MAC/Domain filters are available in this mode.

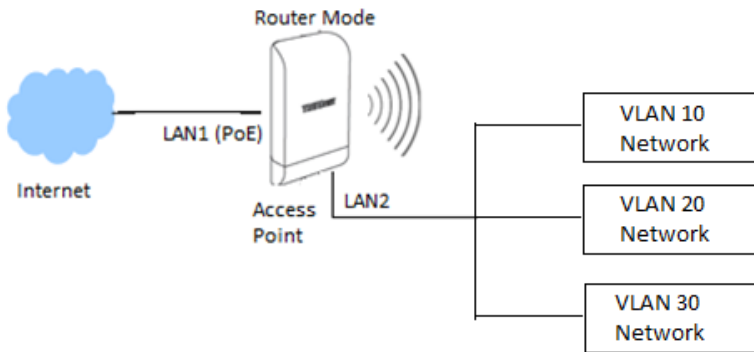
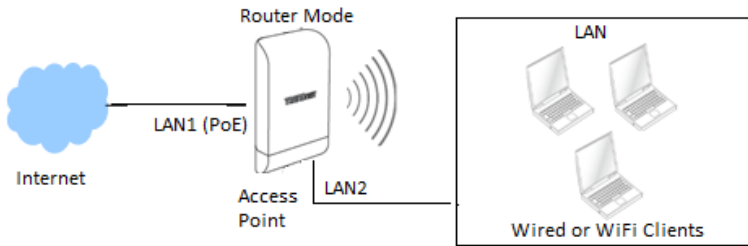

1. Log into your access point management page (see "[Access your access point management page](#)" on page 28).
2. Click **System** and click on **Mode Setup**.
3. Select **Router** in the mode drop down list. Then click **Save & Reboot**.

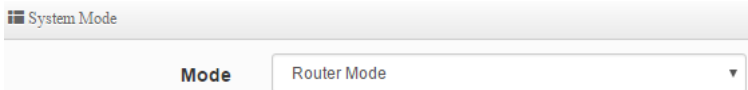

### Set the device LAN IP address settings

*System > VLAN Setup > VLAN 0 > Network*

To set the IP address, gateway, and DNS settings, click on **System** and click on **VLAN Setup**. You can configure the **Default Gateway** IP address and **DNS** addresses on this page. For the LAN IP address, within the first entry in the list VLAN 0, click on **Network**. Click **Save** when you have completed your settings.

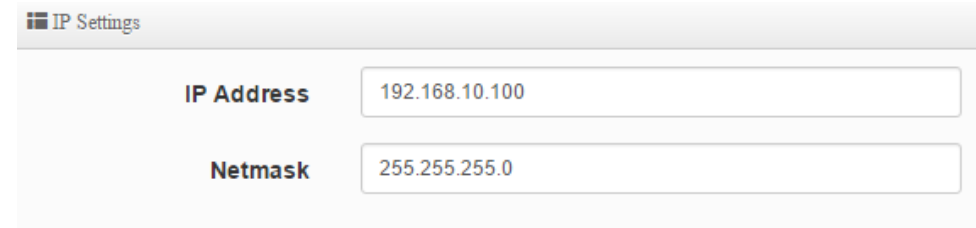

### Configure the LAN DHCP Server

*System > VLAN Setup > VLAN 0 > DHCP Server*

To setup the DHCP Server for LAN and WLAN clients, click on **System** and click on **VLAN Setup**. Within the first entry in the list, VLAN 0, click the arrow next to **Network**, and click on **DHCP Server**.

- **Mode** – Enable or Disable the DHCP service.

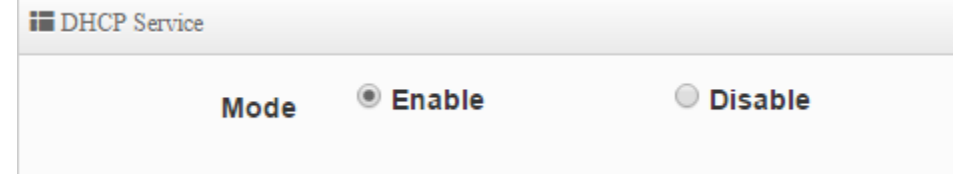

- **Start IP:** Enter the first IP address of the IP address range/pool to distribute to DHCP client devices. (ex. 192.168.10.101)
- **End IP:** Enter the last IP address of the IP address range/pool to distribute to DHCP client devices. (ex. 192.168.10.199)
- **Netmask:** Enter the subnet mask to distribute to DHCP client devices. (ex. 255.255.255.0)
- **Gateway:** Enter the default gateway IP address to distribute to DHCP client devices. This should typically be the LAN IP of the device when using WISP (CPE) + AP mode. (ex. 192.168.10.100)

- **DNS1 IP:** Enter the IP address of the primary DNS server to distribute to DHCP client devices.
- **DNS2 IP:** Enter the IP address of the secondary DNS server to distribute to DHCP client devices.
- **WINS IP:** Enter the IP address of the WINS (Windows Internet Name Service) server to distribute to DHCP client devices. Typically this is used on a Windows network to allow the resolution of computer and device names.
- **Domain:** Enter the domain name to distribute to DHCP client devices. (ex. *trendnet.com*)
- **Lease Time:** Enter the time in seconds how long DHCP client devices will retain their settings assigned by the DHCP service before expiration. Upon expiration, DHCP client devices will initiate new requests for DHCP client settings.

#### DHCP Setup

<b>Start IP</b>	<input type="text"/>
<b>End IP</b>	<input type="text"/>
<b>Netmask</b>	<input type="text" value="255.255.255.0"/>
<b>Gateway</b>	<input type="text"/>
<b>DNS1 IP</b>	<input type="text"/>
<b>DNS2 IP</b>	<input type="text"/>
<b>WINS IP</b>	<input type="text"/>
<b>Domain</b>	<input type="text"/>
<b>Lease Time</b>	<input type="text" value="86400"/>

After the DHCP server settings have been configured and changes have been applied, dynamic DHCP client leases will appear in the **DHCP Client List** table.

#### DHCP Client List

#	IP Address	MAC Address	Expired	Action
-	-	-	-	-

**DHCP Reservation/Static Lease***System > DHCP Setup*

- **Comment:** Add a comment or name to help easily identify the device or purpose of the DHCP static IP lease/reservation.
- **IP Address:** Enter the IP address from the DHCP server IP address range/pool to permanently assign. (ex. 192.168.10.20)
- **MAC Address:** Enter the MAC address of the client device to assign the permanent lease in the example format provided and click **Add** to add the static IP lease to the list. (ex. 00:11:22:AA:BB:CC). Repeat to add additional static IP leases.

Static Lease IP Setup

**Comment**

**IP Address**

**MAC Address**  **Add**

Static Lease IP List

#	Comment	IP Address	MAC Address	Action
-	-	-	-	-

**Configure WAN connection settings***System > WAN Setup*

To setup the WAN interface connection method for the LAN1 Ethernet interface, click on **System** and click on **WAN Setup**. The device supports Dynamic IP, Static IP, PPPoE, and PPTP connection types. Click **Save** when you have completed the changes.

**Note:** Please check with your Internet Service Provider for the required connection settings and configure them accordingly.

- **Static IP** – Your ISP requires the IP address, Subnet Mask, Default Gateway, and DNS Server IP address settings to be manually entered and statically assigned. If required by your ISP, specify the MAC address for this interface.
- **Dynamic** – Your ISP will automatically provide you the IP address, Subnet Mask, Default Gateway, and DNS Server IP address settings. . If required by your WISP, specify the MAC address for this interface.
- **PPPoE (Point-to-Point Protocol over Ethernet)**– Your ISP requires a specifically assigned user name and password for authentication in order to establish connectivity.
- **PPTP (Point-to-Point Tunneling Procotol)** - Your ISP requires a specifically assigned user name and password for authentication in order to establish connectivity similar to PPPoE but a different type of tunneling technology.

WAN Settings

**Mode**

- Dynamic IP
- Static IP
- Dynamic IP
- PPPoE
- PPTP

Dynamic IP

Verify you have established wireless connectivity by attempting to communicate to the Internet.



To setup the DHCP Server for LAN and WLAN clients, click on **System** and click on **VLAN Setup**. Within the first entry in the list, VLAN 0, click the arrow next to **Network**, and click on **DHCP Server**.

To configure the AP wireless settings to allow other wireless clients to connect, click on **System** and click on **VLAN Setup**. Within the first entry in the list, VLAN 0, click the arrow next to **Network**, and click on **Access Point**. Click **Save** when you have completed your settings.

Security

<b>Access Point</b>	<input checked="" type="radio"/> <b>Enable</b>	<input type="radio"/> <b>Disable</b>
<b>ESSID</b>	<input type="text" value="default"/>	
<b>SSID Visibility</b>	<input checked="" type="radio"/> <b>Enable</b>	<input type="radio"/> <b>Disable</b>
<b>Client Isolation</b>	<input checked="" type="radio"/> <b>Enable</b>	<input type="radio"/> <b>Disable</b>
<b>Connection Limit</b>	<input type="radio"/> <b>Enable</b>	<input checked="" type="radio"/> <b>Disable</b>
<b>User Limit</b>	<input type="text" value="64"/>	
<b>IAPP</b>	<input type="radio"/> <b>Enable</b>	<input checked="" type="radio"/> <b>Disable</b>
<b>Security Type</b>	<input type="text" value="Open System"/>	

### DMZ (Demilitarized Zone)

*Advance > DMZ*

You may want to expose a specific computer or device on your network to the Internet to allow anyone to access it. The DMZ (Demilitarized Zone) feature that makes all the ports and services available on the WAN/Internet side and forwards them to a single LAN IP address (computer or network device) on your network. The DMZ feature is an easy way of allowing access from the Internet however, it is a very **insecure** technology and will open local area network to greater threats from Internet attacks.

It is strongly recommended to use **Virtual Server** to allow access to your computers or network devices from the Internet.

**Note:** Make the computer or network device (for which you are establishing a DMZ link) has a static IP address or static DHCP Lease.

1. Log into your access point management page (see "[Access your access point management page](#)" on page 28).
2. Click **Advance** and click on **DMZ**.
3. Review the settings below. Click **Save** when completed.

- **Automatic Assignment** – This option allows you to assign only one DMZ host and forward all traffic requests received on the WAN side to a single LAN IP address.
  - **Internal IP Address** – Enter the LAN IP address to set as the DMZ host to forward all traffic.

Automatic Assignment Setup

<b>Internal IP Address</b>	<input type="text"/>
----------------------------	----------------------

- **Static Assignment** – If you have multiple WAN static IP addresses assigned by your Internet provider, this option allows you to assign multiple DMZ hosts and map them to specific static public/external IP addresses.
  - **External IP Address** – Enter the external public static IP address to map to the internal LAN IP address.
  - **Internal IP Address** – Enter the LAN IP address to set as the DMZ host to forward all traffic.

Static Assignment Setup

<b>External IP Address</b>	<input type="text"/>
<b>Internal IP Address</b>	<input type="text"/>

**IP Filter***Advance > IP Filter*

The IP filter function allows or denies services (or TCP/UDP ports or ICMP) based on source and destination IP address.

1. Log into your access point management page (see "[Access your access point management page](#)" on page 28).
2. Click **Advance** and click on **IP Filter**.
3. In the first IP filter rule entry in the list. Click **Edit**.



4. Review the settings below. Click **Save** when completed.
  - **Active** – Enable or disable the IP Filter rule.
  - **Comment** – Enter a name for the rule so it can easily be identified.
  - **Policy:**
    - **Deny** – This option blocks the port/protocol specified in the rule between source and destination IP address.
    - **Pass** – This option allows the port/protocol specified in the rule between source and destination IP address.
  - **In/Out** – Specify the traffic direction to apply the filter. **In** means ingress or inbound. **Out** means egress or outbound.
  - **Protocol** – Specify the port/protocol to deny or allow.
    - **ALL** – Specifies all TCP/UDP ports and ICMP traffic.
    - **TCP** – Specifies TCP protocol only.
    - **UDP** – Specifies UDP protocol only.
    - **ICMP** – Specifies ICMP traffic only.
  - **Source Address/Mask** – Enter the source IP address/Subnet Mask (CIDR). (ex. 192.168.10.15/32 specifies only IP address 192.168.10.15, Any: 0.0.0.0/0)
  - **Source Port** – Enter the source port number to apply the filter. (ex. Port Range: 1:65535)
  - **Destination Address/Mask** – Enter the destination IP address/Subnet Mask (CIDR). (ex. 10.10.10.30/32)
  - **Destination Port** – Enter the destination port number to apply the filter. (ex. Port

Range: 1:65535)

- **Listen** – Enable or disable filtering only TCP packet that contain the SYN flag. (TCP only).
- **Interface** – Choose the interface the IP filter applies, LAN or WAN.
- **Schedule** – You can specify a schedule under Advance > Time Policy when IP filter rule is active.

**MAC Filter***Advance > MAC Filter*

The MAC Filter function allows or denies traffic based on device MAC addresses.

1. Log into your access point management page (see "[Access your access point management page](#)" on page 28).
2. Click **Advance** and click on **MAC Filter**.
3. Choose the **Mode**.

- **Deny** – Denies traffic from all specified MAC addresses in the list and allows all others. (Blacklist)
- **Allow** – Allows traffic from all specified MAC addresses in the list and denies all others. (Whitelist)

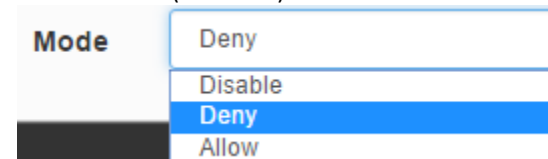

4. In the MAC Filter List, review the settings below and click **Save** to apply changes.

- **Active** – Check this option to enable the entry.
- **Comment** – Enter a name for the rule so it can easily be identified.
- **MAC Address** – Enter the MAC address to deny or allow. (00:11:22:AA:BB:CC)
- **Policy** – You can specify a schedule under Advance > Time Policy when the MAC filter rule is active.

MAC Filter List				
#	Active	Comment	MAC Address	Policy
1	<input type="checkbox"/>			Always Run

## Virtual Server

Advance > Virtual Server

Virtual Server (also called port forwarding) allows you to define specific ports (used or required by a specific application) and forward them to a single IP address (a computer or device) on your network. Using this feature is more secure compared to using DMZ in which DMZ forwards all ports instead of only specific ports used by an application. An example would be forwarding a port to an IP camera (TRENDnet IP cameras default to HTTP TCP port 80 for remote access web requests) on your network to be able to view it over the Internet.

1. Log into your access point management page (see "[Access your access point management page](#)" on page 28).
2. Click **Advance** and click on **Virtual Server**.
3. In the first Virtual Server entry in the list. Click **Edit**.

Edit

4. Review the settings and click **Save** when changes are completed.
  - **Active** – Enable or disable the virtual server.
  - **Comment** – Enter a name for the virtual server so it can easily be identified.
  - **Protocol** – Select the protocol required for your device. **TCP** or **UDP**.
  - **Public Port** – Enter the port number used to access the device from the Internet.
  - **Private IP Address** - Enter the IP address of the device to forward the port (e.g. 192.168.10.101).
  - **Private Port** – Enter the port number required by your device. Refer to the connecting device's documentation for reference to the network port(s) required.
 

**Note:** The Public Port can be assigned a different port number than the Private Port (also known as port redirection), however it is recommended to use the same port number for both settings. Please refer to the device documentation to determine which ports and protocols are required. It is recommended to assign a static IP address to the device or use Static IP Reservation to ensure the IP address of the device does not change.
  - **Schedule** – You can specify a schedule under Advance > Time Policy when Virtual Server is active.

## Access Control

Advance > Access Control

The Access Control function can block TCP/UDP ports and ICMP traffic based on MAC address and/or IP address but also includes content filtering functions such as URL blocking, Keyword blocking, and also blocking specific applications. (Listed applications only)

1. Log into your access point management page (see "[Access your access point management page](#)" on page 28).
2. Click **Advance** and click on **Access Control**.
3. In the first Access Control entry in the list. Click **Edit**.

Edit

4. Review the settings and click **Save** when changes are completed.
  - **Active** – Enable or disable the access control rule.
  - **Comment** – Enter a name for the access control rule it can easily be identified.
  - **Protocol:**
    - **ANY** – Block TCP, UDP, and ICMP.
    - **TCP** – Block TCP protocol only.
    - **UDP** – Block UDP protocol only.
    - **ICMP** – Block ICMP traffic only.
    - **Content Filter** – Block web content based on Keyword. Specify the keywords in the Keyword field and click **Add** to add them to the list.
    - **Application** – Block applications specified in the predefined list. Select specified applications to block in the application drop-down list.
    - **Domain Filter** – Block specific web pages. (HTTP only). Specify the URLs/Domains to block in the Domain field and click **Add** to add them to the list.
  - **Schedule** - You can specify a schedule under Advance > Time Policy when the Access Control rule is active.

**Access Control Rules**

Active  Enable  Disable

Comment

Protocol ANY ▼

Schedule

MAC Address Setup

- **MAC Address** – Enter the device MAC address to apply the access control rule. (ex. 00:11:22:AA:BB:CC) and click **Add** to add it to the list. You can apply the rule to multiple MAC addresses.

**MAC Address Setup**

MAC Address  **Add**

- **IP Address Setup**
  - **Local IP Address** – Enter the IP address range to apply the rule.
  - **Local Port** – Enter the local port number.
  - **Destination IP Address** – Enter the destination IP address to apply the rule.
  - **Destination Port** – Enter the destination port number.

**IP Address Setup**

Local IP Address  -

Local Port

Destination IP Address  -

Destination Port

### Time Policy / Schedule

*Advance > Time Policy*

For additional security control, you can create schedules to specify a time period when a feature should be activated or deactivated. Before you use the scheduling feature, ensure that your device/system time is configured correctly under System > Time Server.

1. Log into your access point management page (see "[Access your access point management page](#)" on page 28).
2. Click **Advance** and click on **Time Policy**.
3. In the first Time Policy entry in the list. Click **Edit**.

**Edit**

4. Review the settings and click **Save** when changes are completed.
  - **Comment** – Enter a name for the time policy so it can be easily identified.
  - **Mode:**
    - **On Schedule:** For the rule used, the schedule will be activated during the time period defined in the schedule and deactivated any time period outside of the defined schedule.

- **Out of Schedule:** For the rule used, the schedule will be deactivated during the time period defined in the schedule and activated any time period outside of the defined schedule.

Time Policy Rules

Comment

Mode  On Schedule  Out Of Schedule

In the Policy List, click **Create New Policy**.



- **End Time** – Define the end time for the time policy. (24-hr format)

Time Policy Rules

Day of Week

Sun  Mon  Tue

Wed  Thu  Fri

Sat

Start Time

End Time

## CAP (Control AP) Mode

CAP mode functions in AP mode but in addition, this mode allows you to manage, monitor, and control other APs using the same firmware/software. You can configure multiple settings for multiple APs at the same time, push out batch firmware upgrades from one convenient GUI interface. The CAP Mode AP can discover and manage any CAP mode compatible APs on any of interfaces including WDS bridged links. **Note:** Currently, the only TRENDnet TEW-740APBO (H/W: v2.XR) is CAP mode firmware/software compatible.

The diagram below displays of a group of CAP mode firmware/software compatible APs either connected through the wired network interfaces or WDS link. One AP is configured in CAP mode is able to discover and centrally manage all other APs in this example scenario.

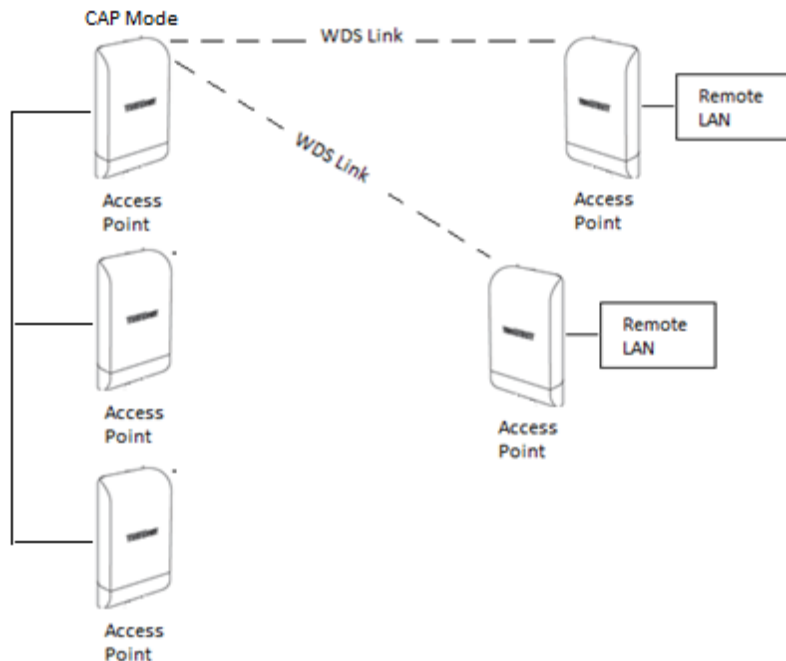

**Note:** You can reference the all the AP mode functions and settings in the AP mode section. This section will primarily cover the CAP mode features only.

1. Log into your access point management page (see "[Access your access point management page](#)" on page 28).
2. Click **System** and click on **Mode Setup**.
3. Select **CAP Mode** in the mode drop down list. Then click **Save & Reboot**.

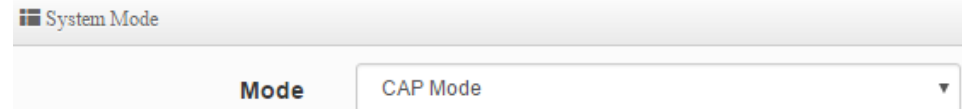

In the top menu, a new section will be available called **AP Control**.

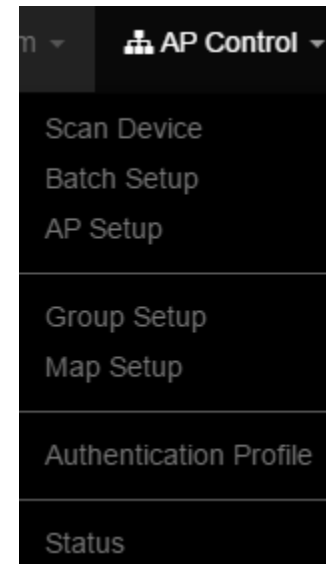

**Scan and Import CAP Mode compatible APs**

AP Control > Scan Device

This function allows you to scan for CAP mode compatible remote APs that are available for management.

**Note:** Please note that the Control Port function must be enabled on the remote access points in order for the remote AP to be manageable by the AP set to CAP mode.

Management

Access Point  Enable  Disable

802.1d Spanning Tree  Enable  Disable

**Control Port  Enable  Disable**

Click **AP Control** and click on **Scan Device**.

In the Filter Device section, enter the criteria to narrow the scope of discovery.

- **VLAN#** – Click the drop-down to select which VLAN to scan for available APs. If you have multiple VLAN interfaces configured on the AP, these VLANs will be available in the drop-down.
- **Default Password**- Enter the default administrator password for the remote APs. By default, TRENDnet APs use default password: admin. If you are using the kit (TEW-740APBO2K H/W: v2.0R), the default password will be a unique predefined administrator password found on the device label or wireless settings sticker.
- **Sort** – Click the drop-down list and select which parameter to use to sort the APs in the Scan Result list, **IP Address** or **MAC Address**

Filter Device

VLAN#

Default Password

Sort

After you have discovered the manageable APs, the Update IP Address & Netmask section will allow you to assign batch IP address and subnet mask configuration to all of the APs discovered.

- **Control Port** – Click the drop-down list to select which VLAN and IP subnet the APs can be managed. By default, TRENDnet APs have the Control Port capability enabled on native VLAN 0 under the 192.168.10.0/24 IP subnet.
- **VLAN** – If VLAN tagging is enabled on the remote APs along with the control port feature, check the option and add the correct VLAN tag for the management VLAN to access the APs. **Note:** By default, TRENDnet APs have management enabled on native VLAN 0, untagged VLAN interface.
- **IP Address** – Enter the starting IP address to assign to the listed APs. IP addressing will automatically assign and auto increment the IP assignment by one for each AP.
- **Netmask** – Enter the subnet mask to assign to the APs.

Update IP Address & Netmask

Control Port

VLAN TAG

IP Address

Netmask

To add the AP to the managed list, check the entry under the **Device** column and click on **Import** to add the AP to the managed list.

Scan Result

#	Device	IP Address	MAC Address	Password	Host Name	F/W Version	F/W Date	IP Address	Netmask	Action
1	<input checked="" type="checkbox"/>	192.168.10.51	00:22:aa:00:12:06	*****	TEW-740APBO	Pme-CPE-AP12X V2.0R	2016/12/08 13:33:58	192.168.10.51	255.255.255.0	<input type="button" value="Info"/>

**Modify and view your managed AP list**

AP Control > AP Setup

In this section, you can view the currently managed APs, remove APs, reboot, or configure settings such as group assignment, IP address, password and GUI HTTP port.

Click **AP Control** and click on **AP Setup**. The list displays all of the imported APs to manage. From the managed AP list, you can delete or reboot the APs in the list. To select multiple APs, tick the option under the **Device** column.

Device List							
VLAN#	Device	Status	System Name	IP Address	MAC Address	Uptime	Action
VLAN0	<input type="checkbox"/>		TEW-740APBO	192.168.10.51	00:22:aa:00:12:06	03:06:49	Setup

For the selected AP entry, click on **Setup**.

You can change the management settings used to access the AP such as AP group assignment, IP address, administrator password. Click **Save** to apply the changes.

Device Setup

**VLAN**

**Group**

**IP Address**

**MAC Address**

**Password**

**HTTP Port**

**Batch Configuration Settings**

AP Control > Batch Setup

This section allows you to apply configuration change to multiple APs by VLAN group including batch configuration and firmware upgrade.

Click **AP Control** and click on **Batch Setup**.

- **VLAN** – Select the VLAN group you would like to apply changes. Once selected, the APs part of the selected VLAN group will appear under the Device List. You can check which APs in the list you would like to apply the configuration settings.
- **Group** – Click the drop-down list to select the group name assignment. You can create groups by VLAN under AP Control > Group Setup.
- **Batch Setup** – Click the drop-down list and select which configuration settings to configure and assign to the selected APs. Enter the settings you would like to apply, then click Apply to apply the configuration to the selected APs.



VLAN List

**VLAN**

**Group**

**Batch Setup**

- VLAN Setup
- Authentication Profile
- Gateway & DNS
- Time Server
- Management Setup
- Wireless Basic Setup
- Wireless Advanced Setup
- VAP Setup
- Upgrade Via TFTP Server
- Upgrade Via HTTP URL
- Reboot

Device List

Choice	VLAN#
<input checked="" type="checkbox"/>	VLAN 0



## Group Setup

AP Control > Group Setup

This section allows you to create specific AP groups for batch configuration to be applied.

Click **AP Control** and click on **Map Setup**. Click **Create New Map**. Click **Save** to save the new map reference.

- **Map Name** – Enter a name to identify this map.
- **Image URL** – Enter the URL location of the image to use.
- **Description** – Enter a brief text description to help further provide detail about the map.
- **Image** – After the correct image URL has been provided, click **View** to view the map.

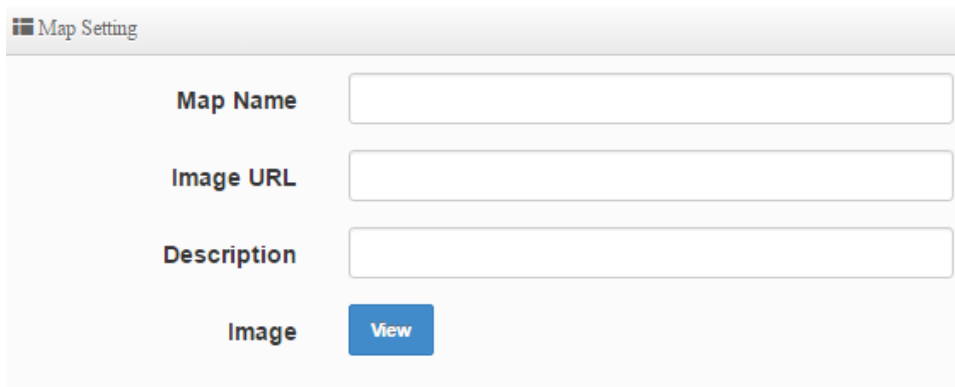

The screenshot shows the 'Map Setting' form. It has a title bar with a small icon and the text 'Map Setting'. Below the title bar, there are three input fields: 'Map Name', 'Image URL', and 'Description'. Each field is a simple white box with a thin border. Below the 'Image' label, there is a blue button with the text 'View' in white.

## Map Setup

AP Control > Map Setup

This section allows you to reference online maps to help you identify AP deployment areas and locations. Please note that you can only reference and view maps from interface only. Map editing is not supported. You will need to create and edit your map using another third party software.

Click **AP Control** and click on **Map Setup**. Click **Create New Map**. Click **Save** to save the new map reference.

- **Map Name** – Enter a name to identify this map.
- **Image URL** – Enter the URL location of the image to use.
- **Description** – Enter a brief text description to help further provide detail about the map.
- **Image** – After the correct image URL has been provided, click **View** to view the map.

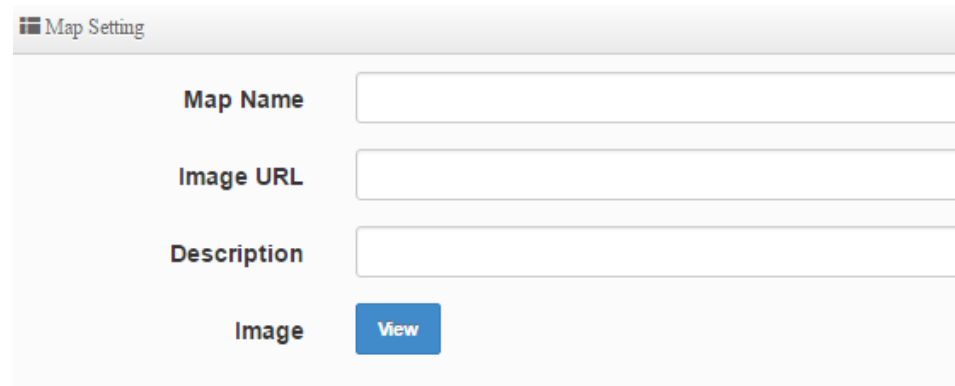

The screenshot shows the 'Map Setting' form. It has a title bar with a small icon and the text 'Map Setting'. Below the title bar, there are three input fields: 'Map Name', 'Image URL', and 'Description'. Each field is a simple white box with a thin border. Below the 'Image' label, there is a blue button with the text 'View' in white.

**Authentication Profile**

AP Control > Authentication Profile

If you are using the AP authentication feature across multiple APs, this section allows you to create authentication profiles to apply per VLAN to multiple APs through the Batch Setup section.

Click **AP Control** and click on **Authentication Profile**. Click **Create New Profile**. Click **Save** to save the new authentication profile.

- **Profile Name** –Enter a name to identify this authentication profile.
- **Description** – Enter a brief text description to help further provide detail about the profile.

After you have created the new profile, in the entry in the list, click on the drop-down arrow next to **Authentication**. You'll be able to create the customized authentication settings for the newly created profile. After you created your customized authentication profile, the profile can be applied to multiple APs under AP Control > Batch Setup.

#	Name	Description	Authentication	Edit	Action
1	test		Auth	Authentication	Setup

**Managed AP Status**

AP Control > Status

This section provides status information about all of the current APs managed by the CAP mode AP.

Click **AP Control** and click on **Status**.

VLAN#	Status	System Name	IP Address	Uptime	Radio Information	Receive(Bytes)	Transmit(Bytes)	User(s)
VLAN0	🟢	TEW-740APBO	192.168.10.51	04:10:01	1(144.4 Mb/s)	2.43KB	444B	0

## Technical Specifications

### Standards

- IEEE 802.3
- IEEE 802.3u
- IEEE 802.1d
- IEEE 802.1p
- IEEE 802.1Q
- IEEE 802.1X
- IEEE 802.11d
- IEEE 802.11e
- IEEE 802.11f
- IEEE 802.11h
- IEEE 802.11i
- IEEE 802.11b
- IEEE 802.11g
- IEEE 802.11n (2.4 GHz up to 300 Mbps)
- IEEE 802.11r
- IEEE 802.11k

### Hardware Interface

- 1 x 10/100 Mbps LAN1 port (proprietary PoE max. cable length 60 m (197 ft.))
- 1 x 10/100 Mbps LAN2 port
- LED indicators
- Reset button
- Grounding Point

### Special Features

- IPX6 weather rated
- 802.1Q VLAN assignment per SSID
- Schedule radio on/off time policy
- 802.11r / 802.11k fast roaming

### Access Control

- Wireless encryption: WPA/WPA2-PSK, WPA/WPA2-Enterprise, 802.1X
- Firewall (CPE Mode): NAT, Virtual Server, DMZ Host, PPTP/L2TP/IPsec VPN Passthrough
- Access Controls: MAC, IP Filter, Layer 2 Client Isolation, Per-SSID client limiting
- 802.1Q VLAN
- OAuthentication 2.0 / Walled Garden for guest authentication
- Customizable Captive Portal for guest authentication

### QoS

- WMM

### Operation Modes

- Access Point (AP)
- Access Point (AP) + WDS
- Wireless Distribution System (WDS)
- WISP (CPE) + AP
- Client Bridge + AP
- Router
- Control AP (CAP)

### SSID

- Up to 7 SSIDs

### Internet Connection Types (WISP (CPE) + AP & Router modes)

- Dynamic IP (DHCP)
- Static IP (Fixed)
- PPPoE (Dynamic IP/Static IP)
- PPTP (Dynamic IP/Static IP)

### Management/Monitoring

- Local/remote web based management (HTTP, HTTPS)
- Local/remote CLI based management (Telnet, SSH)
- SNMP v2c/v3
- SNMP Trap
- Upgrade firmware

- Backup/restore configuration
- Event logging
- Authentication log
- Reboot
- Restore to factory defaults
- Ping test
- Traceroute
- LED Control

**Frequency**

- FCC: 2.412 - 2.462 GHz
- ETSI: 2.412 – 2.472 GHz
- IC: 2.412 - 2.462 GHz

**Wireless Channels**

- FCC: 1-11
- ETSI: 1-13

**Modulation**

- 802.11b: DBPK, DQPSK, CCK with DSSS
- 802.11g/n: BPSK, QPSK, 16-QAM, 64-QAM with OFDM

**Media Access Protocol**

- CSMA/CA with ACK

**Antenna Gain**

- 10 dBi internal sector antenna

**Wireless Output Power/Receiving Sensitivity**

- 802.11b: FCC/ETSI: FCC: 28 dBm (max.), ETSI: 10.4 dBm (max.), IC: 28 dBm (max.)/-88 dBm (typical) @ 11 Mbps
- 802.11g: FCC/ETSI: FCC: 26 dBm (max.), ETSI: 10.5 dBm (max.), IC: 26 dBm (max.)/- 74 dBm (typical) @ 54 Mbps

- 802.11n: FCC/ETSI: FCC: 26 dBm (max.), ETSI: 10.6 dBm (max.), IC: 26 dBm (max.)/- 69 dBm (typical) @ 300 Mbps

**Power**

- Input: 100 – 220 V, 50 - 60 Hz, 0.5 A
- Output: 12V / 1A
- Consumption: 13.5 Watts Max.

**Operating Temperature**

- -20 - 60° C (-4 - 140° F)

**Operating Humidity**

- Max. 99 % non-condensing

**Certifications**

- CE
- FCC

**Dimensions**

- 195 x 118 x 61 mm (7.6 x 4.6 x 2.4 in.)

**Weight**

- 320 g (0.7 lbs.)

**Disclaimer**

\* Effective wireless coverage may vary depending on the wireless device's output power, antenna gain, antenna alignment, receiving sensitivity, and radio interference. Additionally, environmental factors such as weather conditions, physical obstacles, and other considerations may affect performance. For optimal results, we recommended consulting a professional installer for site survey, safety precautions, and proper installation.

## Appendix

### How to find your IP address?

**Note:** Please note that although the following procedures provided to follow for your operating system on configuring your network settings can be used as general guidelines, however, it is strongly recommended that you consult your computer or operating system manufacturer directly for assistance on the proper procedure for configuring network settings.

#### Command Prompt Method

##### **Windows 2000/XP/Vista/7/8.1/10**

1. On your keyboard, press **Windows Logo+R** keys simultaneously to bring up the Run dialog box.
2. In the dialog box, type **cmd** to bring up the command prompt.
3. In the command prompt, type **ipconfig /all** to display your IP address settings.

##### **MAC OS X**

1. Navigate to your **Applications** folder and open **Utilities**.
2. Double-click on **Terminal** to launch the command prompt.
3. In the command prompt, type **ipconfig getifaddr <en0 or en1>** to display the wired or wireless IP address settings.

**Note:** **en0** is typically the wired Ethernet and **en1** is typically the wireless Airport interface.

#### Graphical Method

##### **MAC OS 10.6/10.5**

1. From the Apple menu, select **System Preferences**.
2. In System Preferences, from the **View** menu, select **Network**.
3. In the Network preference window, click a network port (e.g., Ethernet, AirPort, modem). If you are connected, you'll see your IP address settings under "Status:"

##### **MAC OS 10.4**

1. From the Apple menu, select **Location**, and then **Network Preferences**.
2. In the Network Preference window, next to "Show:", select **Network Status**. You'll see your network status and your IP address settings displayed.

**Note:** If you are experiencing difficulties, please contact your computer or operating system manufacturer for assistance.

### How to configure your network settings to obtain an IP address automatically or use DHCP?

**Note:** Please note that although the following procedures provided to follow for your operating system on configuring your network settings can be used as general guidelines, however, it is strongly recommended that you consult your computer or operating system manufacturer directly for assistance on the proper procedure for configuring network settings.

#### **Windows 7/8.1/10**

- a. Go into the **Control Panel**, click **Network and Sharing Center**.
- b. Click **Change Adapter Settings**, right-click the **Local Area Connection** icon.
- c. Then click **Properties** and click **Internet Protocol Version 4 (TCP/IPv4)**.
- d. Then click **Obtain an IP address automatically** and click **OK**.

#### **Windows Vista**

- a. Go into the **Control Panel**, click **Network and Internet**.
- b. Click **Manage Network Connections**, right-click the **Local Area Connection** icon and click **Properties**.
- c. Click **Internet Protocol Version (TCP/IPv4)** and then click **Properties**.
- d. Then click **Obtain an IP address automatically** and click **OK**.

#### **Windows XP/2000**

- a. Go into the **Control Panel**, double-click the **Network Connections** icon
- b. Right-click the **Local Area Connection** icon and the click **Properties**.
- c. Click **Internet Protocol (TCP/IP)** and click **Properties**.
- d. Then click **Obtain an IP address automatically** and click **OK**.

#### **MAC OS 10.4/10.5/10.6**

- a. From the **Apple**, drop-down list, select **System Preferences**.
- b. Click the **Network** icon.
- c. From the **Location** drop-down list, select **Automatic**.
- d. Select and view your Ethernet connection.
  - In MAC OS 10.4, from the **Show** drop-down list, select **Built-in Ethernet** and select the **TCP/IP** tab.
  - In MAC OS 10.5/10.6, in the left column, select **Ethernet**.
- e. Configure TCP/IP to use DHCP.

In MAC 10.4, from the **Configure IPv4**, drop-down list, select **Using DHCP** and click the **Apply Now** button.

In MAC 10.5, from the **Configure** drop-down list, select **Using DHCP** and click the **Apply** button.

In MAC 10.6, from the **Configure** drop-down list, select **Using DHCP** and click the **Apply** button.

f. Restart your computer.

**Note:** *If you are experiencing difficulties, please contact your computer or operating system manufacturer for assistance.*

#### How to configure your network settings to use a static IP address?

**Note:** *Please note that although the following procedures provided to follow for your operating system on configuring your network settings can be used as general guidelines, however, it is strongly recommended that you consult your computer or operating system manufacturer directly for assistance on the proper procedure for configuring network settings.*

#### Windows 7/8.1/10

- a. Go into the **Control Panel**, click **Network and Sharing Center**.
- b. Click **Change Adapter Settings**, right-click the **Local Area Connection** icon.
- c. Then click **Properties** and click **Internet Protocol Version 4 (TCP/IPv4)**.
- d. Then click **Use the following IP address**, and assign your network adapter a static IP address. Click **OK**

#### Windows Vista

- a. Go into the **Control Panel**, click **Network and Internet**.
- b. Click **Manage Network Connections**, right-click the **Local Area Connection** icon and click **Properties**.
- c. Click **Internet Protocol Version (TCP/IPv4)** and then click **Properties**.
- d. Then click **Use the following IP address**, and assign your network adapter a static IP address. Click **OK**

#### Windows XP/2000

- a. Go into the **Control Panel**, double-click the **Network Connections** icon
- b. Right-click the **Local Area Connection** icon and the click **Properties**.
- c. Click **Internet Protocol (TCP/IP)** and click **Properties**.

d. Then click **Use the following IP address**, and assign your network adapter a static IP address. Click **OK**

#### MAC OS 10.4/10.5/10.6

- a. From the **Apple**, drop-down list, select **System Preferences**.
- b. Click the **Network** icon.
- c. From the **Location** drop-down list, select **Automatic**.
- d. Select and view your Ethernet connection.

#### How to find your MAC address?

In Windows 2000/XP/Vista/7/8,

Your computer MAC addresses are also displayed in this window, however, you can type **getmac -v** to display the MAC addresses only.

In MAC OS 10.4,

1. **Apple Menu > System Preferences > Network**
2. From the **Show** menu, select **Built-in Ethernet**.
3. On the **Ethernet** tab, the **Ethernet ID** is your MAC Address.

In MAC OS 10.5/10.6,

1. **Apple Menu > System Preferences > Network**
2. Select **Ethernet** from the list on the left.
3. Click the **Advanced** button.
3. On the **Ethernet** tab, the **Ethernet ID** is your MAC Address.

**How do I use the ping tool to check for network device connectivity?****Windows 2000/XP/Vista/7/8.1/10**

1. On your keyboard, press **Windows Logo+R** keys simultaneously to bring up the Run dialog box.
2. In the dialog box, type **cmd** to bring up the command prompt.
3. In the command prompt, type **ping <ip\_address>** with the *<ip\_address>* being the IP address you want ping and check for connectivity.

**Example:** Usage of ping command and successful replies from device.

```
C:\Users>ping 192.168.10.100
```

```
Pinging 192.168.10.100 with 32 bytes of data:
```

```
Reply from 192.168.10.100: bytes=32 time<1ms TTL=64
```

```
Reply from 192.168.10.100: bytes=32 time<1ms TTL=64
```

```
Reply from 192.168.10.100: bytes=32 time<1ms TTL=64
```

```
Reply from 192.168.10.100: bytes=32 time<1ms TTL=64
```

Ping statistics for 192.168.10.100:

```
Packets: Sent = 4, Received = 4, Lost = 0 (0% loss),
```

Approximate round trip times in milli-seconds:

```
Minimum = 0ms, Maximum = 0ms, Average = 0ms
```

**MAC OS X**



1. Navigate to your **Applications** folder and open **Utilities**.
2. Double-click on **Terminal** to launch the command prompt.
3. In the command prompt, type **ping -c <#> <ip\_address>** with the *<#>* ping being the number of time you want to ping and the *<ip\_address>* being the IP address you want ping and check for connectivity.

**Example:** `ping -c 4 192.168.10.100`

**How to connect to a wireless network using the built-in Windows utility?**

**Note:** Please note that although the following procedures provided to follow for your operating system on configuring your network settings can be used as general guidelines, however, it is strongly recommended that you consult your computer or operating system manufacturer directly for assistance on the proper procedure for connecting to a wireless network using the built-in utility.

**Windows 7/8.1/10**

1. Open Connect to a Network by clicking the network icon ( or ) in the notification area.
2. In the list of available wireless networks, click the wireless network you would like to connect to, then click **Connect**.
4. You may be prompted to enter a security key in order to connect to the network.
5. Enter in the security key corresponding to the wireless network, and click **OK**.

**Windows Vista**

1. Open Connect to a Network by clicking the **Start Button**  and then click **Connect To**.
2. In the **Show** list, click **Wireless**.
3. In the list of available wireless networks, click the wireless network you would like to connect to, then click **Connect**.
4. You may be prompted to enter a security key in order to connect to the network.
5. Enter in the security key corresponding to the wireless network, and click **OK**.

**Windows XP**

1. Right-click the network icon in the notification area, then click **View Available Wireless Networks**.
2. In **Connect to a Network**, under **Available Networks**, click the wireless network you would like to connect to.
3. You may be prompted to enter a security key in order to connect to the network.
4. Enter in the security key corresponding to the wireless network, and click **Connect**.

### Federal Communication Commission Interference Statement

This equipment has been tested and found to comply with the limits for a Class B digital device, pursuant to Part 15 of the FCC Rules. These limits are designed to provide reasonable protection against harmful interference in a residential installation. This equipment generates, uses and can radiate radio frequency energy and, if not installed and used in accordance with the instructions, may cause harmful interference to radio communications. However, there is no guarantee that interference will not occur in a particular installation. If this equipment does cause harmful interference to radio or television reception, which can be determined by turning the equipment off and on, the user is encouraged to try to correct the interference by one of the following measures:

- Reorient or relocate the receiving antenna.
- Increase the separation between the equipment and receiver.
- Connect the equipment into an outlet on a circuit different from that to which the receiver is connected.
- Consult the dealer or an experienced radio/TV technician for help.



FCC Caution: Any changes or modifications not expressly approved by the party responsible for compliance could void the user's authority to operate this equipment.

This device complies with Part 15 of the FCC Rules. Operation is subject to the following two conditions: (1) This device may not cause harmful interference, and (2) this device must accept any interference received, including interference that may cause undesired operation.

#### IMPORTANT NOTE:

##### Radiation Exposure Statement:

This equipment complies with FCC radiation exposure limits set forth for an uncontrolled environment. This equipment should be installed and operated with minimum distance 20cm between the radiator & your body.

This transmitter must not be co-located or operating in conjunction with any other antenna or transmitter.

Country Code selection feature to be disabled for products marketed to the US/CANADA

### Europe – EU Declaration of Conformity

TRENDnet hereby declare that the product is in compliance with the essential requirements and other relevant provisions under our sole responsibility.

#### Safety

EN 60950-1: 2006 + A11: 2010 + A12: 2011 + A2: 2013

#### EMC

EN 301 489-1 V1.9.2: 09-2011

EN 301 489-17 V2.2.1: 09-2012

EN 55024: 2010 + A1: 2015

EN 55032: 2015



#### Radio Spectrum & Health

EN 300 328 V1.8.1: 02-2015

EN 62311: 2008

#### Energy Efficiency

Regulation (EC) No. 1275/2008, No. 801/2013

This product is herewith confirmed to comply with the Directives.

#### Directives

Low Voltage Directive 2014/35/EU

EMC Directive 2014/30/EU

RED Directive 2014/53/EU

RoHS Directive 2011/65/EU

REACH Regulation (EC) No. 1907/2006

This device is designed to provide uninterrupted monitoring and/or recording. This device does not offer power management functionality such as Off mode or Standby mode.



<b>cs</b> Český [Czech]	TRENDnet tímto prohlašuje, že tento TEW-740APBO je ve shodě se základními požadavky a dalšími příslušnými ustanoveními směrnice 2014/35/EU, 2014/30/EU, 2014/53/EU, a 2011/65/EU.
<b>da</b> Dansk [Danish]	Undertegnede TRENDnet erklærer herved, at følgende udstyr TEW-740APBO overholder de væsentlige krav og øvrige relevante krav i direktiv 2014/35/EU, 2014/30/EU, 2014/53/EU, og 2011/65/EU.
<b>de</b> Deutsch [German]	Hiermit erklärt TRENDnet, dass sich das Gerät TEW-740APBO in Übereinstimmung mit den grundlegenden Anforderungen und den übrigen einschlägigen Bestimmungen der Richtlinie 2014/35/EU, 2014/30/EU, 2014/53/EU, und 2011/65/EU befindet.
<b>et</b> Eesti [Estonian]	Käesolevaga kinnitab TRENDnet seadme TEW-740APBO vastavust direktiivi 2014/35/EU, 2014/30/EU, 2014/53/EU, ja 2011/65/EU põhinõuetele ja nimetatud direktiivist tulenevatele teistele asjakohastele sätetele.
<b>en</b> English	Hereby, TRENDnet, declares that this TEW-740APBO is in compliance with the essential requirements and other relevant provisions of Directive 2014/35/EU, 2014/30/EU, 2014/53/EU, and 2011/65/EU.
<b>es</b> Español [Spanish]	Por medio de la presente TRENDnet declara que el TEW-740APBO cumple con los requisitos esenciales y cualesquiera otras disposiciones aplicables o exigibles de la Directiva 2014/35/EU, 2014/30/EU, 2014/53/EU, 2011/65/EU y.
<b>el</b> Ελληνική [Greek]	ΜΕ ΤΗΝ ΠΑΡΟΥΣΑΤRENDnet ΔΗΛΩΝΕΙ ΟΤΙΤΕW-740ΑΡΒΟΣΥΜΜΟΡΦΩΝΕΤΑΙ ΠΡΟΣ ΤΙΣ ΟΥΣΙΩΔΕΙΣ ΑΠΑΙΤΗΣΕΙΣ ΚΑΙ ΤΙΣ ΛΟΙΠΕΣ ΣΧΕΤΙΚΕΣ ΔΙΑΤΑΞΕΙΣ ΤΗΣ ΟΔΗΓΙΑΣ 2014/35/EU, 2014/30/EU, 2014/53/EU, 2011/65/EU και.
<b>fr</b> Français [French]	Par la présente TRENDnet déclare que l'appareil TEW-740APBO est conforme aux exigences essentielles et aux autres dispositions pertinentes de la 2014/35/EU, 2014/30/EU, 2014/53/EU, 2011/65/UE et.
<b>it</b> Italiano [Italian]	Con la presente TRENDnet dichiara che questo TEW-740APBO è conforme ai requisiti essenziali ed alle altre disposizioni pertinenti stabilite dalla direttiva 2014/35/EU, 2014/30/EU, 2014/53/EU, e 2011/65/EU.
Latviski [Latvian]	Ar šo TRENDnet deklarē, ka TEW-740APBO atbilst Direktīvas 2014/35/EU, 2014/30/EU, 2014/53/EU, un 2011/65/EU būtiskajām prasībām un citiem ar to saistītajiem noteikumiem.
Lietuvių [Lithuanian]	Šiuo TRENDnet deklaruoja, kad šis TEW-740APBO atitinka esminius reikalavimus ir kitas 2014/35/EU, 2014/30/EU, 2014/53/EU, ir 2011/65/EU Direktyvos nuostatas.
<b>nl</b> Nederlands [Dutch]	Hierbij verklaart TRENDnet dat het toestel TEW-740APBO in overeenstemming is met de essentiële eisen en de andere relevante

	bepalingen van richtlijn 2014/35/EU, 2014/30/EU, 2014/53/EU, en 2011/65/EU.
<b>mt</b> Malti [Maltese]	Hawnhekk, TRENDnet, jiddikjara li dan TEW-740APBO jikkonforma mal-ħtiġijiet essenzjali u ma provvedimenti oħrajn relevanti li hemm fid-Dirrettiva 2014/35/EU, 2014/30/EU, 2014/53/EU, u 2011/65/EU.
<b>hu</b> Magyar [Hungarian]	Alulírott, TRENDnet nyilatkozom, hogy a TEW-740APBO megfelel a vonatkozó alapvető követelményeknek és az 2014/35/EU, 2014/30/EU, 2014/53/EU, irányelv és a 2011/65/EU irányelv egyéb előírásainak.
<b>pl</b> Polski [Polish]	Niniejszym TRENDnet oświadcza, że TEW-740APBO jest zgodny z zasadniczymi wymogami oraz pozostałymi stosownymi postanowieniami Dyrektywy 2014/35/EU, 2014/30/EU, 2014/53/EU, i 2011/65/EU.
<b>pt</b> Português [Portuguese]	TRENDnet declara que este TEW-740APBO está conforme com os requisitos essenciais e outras disposições da Directiva 2014/35/EU, 2014/30/EU, 2014/53/EU, e 2011/65/EU.
<b>sl</b> Slovensko [Slovenian]	TRENDnet izjavlja, da je ta TEW-740APBO v skladu z bistvenimi zahtevami in ostalimi relevantnimi določili direktive 2014/35/EU, 2014/30/EU, 2014/53/EU, in 2011/65/EU.
Slovensky [Slovak]	TRENDnet týmto vyhlasuje, že TEW-740APBO spĺňa základné požiadavky a všetky príslušné ustanovenia Smernice 2014/35/EU, 2014/30/EU, 2014/53/EU, a 2011/65/EU.
<b>fi</b> Suomi [Finnish]	TRENDnet vakuuttaa täten että TEW-740APBO tyyppinen laite on direktiivin 2014/35/EU, 2014/30/EU, 2014/53/EU, ja 2011/65/EU oleellisten vaatimusten ja sitä koskevien direktiivin muiden ehtojen mukainen.
<b>sv</b> Svenska [Swedish]	Härmed intygar TRENDnet att denna TEW-740APBO står i överensstämmelse med de väsentliga egenskapskrav och övriga relevanta bestämmelser som framgår av direktiv 2014/35/EU, 2014/30/EU, 2014/53/EU, och 2011/65/EU.

**Industry Canada Statement**

---

This device complies with Industry Canada license-exempt RSS standard(s). Operation is subject to the following two conditions: (1) this device may not cause interference, and (2) this device must accept any interference, including interference that may cause undesired operation of the device.

*Le présent appareil est conforme aux CNR d'Industrie Canada applicables aux appareils radio exempts de licence. L'exploitation est autorisée aux deux conditions suivantes : (1) l'appareil ne doit pas produire de brouillage, et (2) l'utilisateur de l'appareil doit accepter tout brouillage radioélectrique subi, même si le brouillage est susceptible d'en compromettre le fonctionnement.*

**Radiation Exposure Statement:**

This equipment complies with IC radiation exposure limits set forth for an uncontrolled environment. This equipment should be installed and operated with minimum distance 20cm between the radiator & your body.

**Déclaration d'exposition aux radiations:**

Cet équipement est conforme aux limites d'exposition aux rayonnements IC établies pour un environnement non contrôlé. Cet équipement doit être installé et utilisé avec un minimum de 20 cm de distance entre la source de rayonnement et votre corps.

## Limited Warranty

---

TRENDnet warrants only to the original purchaser of this product from a TRENDnet authorized reseller or distributor that this product will be free from defects in material and workmanship under normal use and service. This limited warranty is non-transferable and does not apply to any purchaser who bought the product from a reseller or distributor not authorized by TRENDnet, including but not limited to purchases from Internet auction sites.

### Limited Warranty

TRENDnet warrants its products against defects in material and workmanship, under normal use and service. Specific warranty periods are listed on each of the respective product pages on the TRENDnet website.

- AC/DC Power Adapter, Cooling Fan, and Power Supply carry a one-year warranty.

### Limited Lifetime Warranty

TRENDnet offers a limited lifetime warranty for all of its metal-enclosed network switches that have been purchased in the United States/Canada on or after 1/1/2015.

- Cooling fan and internal power supply carry a one-year warranty

To obtain an RMA, the ORIGINAL PURCHASER must show Proof of Purchase and return the unit to the address provided. The customer is responsible for any shipping-related costs that may occur. Replacement goods will be shipped back to the customer at TRENDnet's expense.

Upon receiving the RMA unit, TRENDnet may repair the unit using refurbished parts. In the event that the RMA unit needs to be replaced, TRENDnet may replace it with a refurbished product of the same or comparable model.

In the event that, after evaluation, TRENDnet cannot replace the defective product or there is no comparable model available, we will refund the depreciated value of the product.

If a product does not operate as warranted during the applicable warranty period, TRENDnet shall reserve the right, at its expense, to repair or replace the defective product or part and deliver an equivalent product or part to the customer. The repair/replacement unit's warranty continues from the original date of purchase. All products that are replaced become the property of TRENDnet. Replacement products may be new or reconditioned. TRENDnet does not issue refunds or credit. Please contact the point-of-purchase for their return policies.

TRENDnet shall not be responsible for any software, firmware, information, or memory data of customer contained in, stored on, or integrated with any products returned to TRENDnet pursuant to any warranty.

There are no user serviceable parts inside the product. Do not remove or attempt to service the product by any unauthorized service center. This warranty is voided if (i) the product has been modified or repaired by any unauthorized service center, (ii) the product was subject to accident, abuse, or improper use, or (iii) the product was subject to conditions more severe than those specified in the manual.

Warranty service may be obtained by contacting TRENDnet within the applicable warranty period and providing a copy of the dated proof of the purchase. Upon proper submission of required documentation, a Return Material Authorization (RMA) number will be issued. An RMA number is required in order to initiate warranty service support for all TRENDnet products. Products that are sent to TRENDnet for RMA service must have the RMA number marked on the outside of return packages and sent to TRENDnet prepaid, insured and packaged appropriately for safe shipment. International customers

shipping from outside of the USA and Canada are responsible for any return shipping and/or customs charges, including but not limited to, duty, tax, and other fees.

**Refurbished product:** Refurbished products carry a 90-day warranty after date of purchase. Please retain the dated sales receipt with purchase price clearly visible as evidence of the original purchaser's date of purchase. Replacement products may be refurbished or contain refurbished materials. If TRENDnet, by its sole determination, is unable to replace the defective product, we will offer a refund for the depreciated value of the product.

**WARRANTIES EXCLUSIVE:** IF THE TRENDNET PRODUCT DOES NOT OPERATE AS WARRANTED ABOVE, THE CUSTOMER'S SOLE REMEDY SHALL BE, AT TRENDNET'S OPTION, REPAIR OR REPLACE. THE FOREGOING WARRANTIES AND REMEDIES ARE EXCLUSIVE AND ARE IN LIEU OF ALL OTHER WARRANTIES, EXPRESSED OR IMPLIED, EITHER IN FACT OR BY OPERATION OF LAW, STATUTORY OR OTHERWISE, INCLUDING WARRANTIES OF MERCHANTABILITY AND FITNESS FOR A PARTICULAR PURPOSE. TRENDNET NEITHER ASSUMES NOR AUTHORIZES ANY OTHER PERSON TO ASSUME FOR IT ANY OTHER LIABILITY IN CONNECTION WITH THE SALE, INSTALLATION, MAINTENANCE, OR USE OF TRENDNET'S PRODUCTS.

TRENDNET SHALL NOT BE LIABLE UNDER THIS WARRANTY IF ITS TESTING AND EXAMINATION DISCLOSE THAT THE ALLEGED DEFECT IN THE PRODUCT DOES NOT EXIST OR WAS CAUSED BY CUSTOMER'S OR ANY THIRD PERSON'S MISUSE, NEGLIGENCE, IMPROPER INSTALLATION OR TESTING, UNAUTHORIZED ATTEMPTS TO REPAIR OR MODIFY, OR ANY OTHER CAUSE BEYOND THE RANGE OF THE INTENDED USE, OR BY ACCIDENT, FIRE, LIGHTNING, OR OTHER HAZARD.

LIMITATION OF LIABILITY: TO THE FULL EXTENT ALLOWED BY LAW, TRENDNET ALSO EXCLUDES FOR ITSELF AND ITS SUPPLIERS ANY LIABILITY, WHETHER BASED IN

CONTRACT OR TORT (INCLUDING NEGLIGENCE), FOR INCIDENTAL, CONSEQUENTIAL, INDIRECT, SPECIAL, OR PUNITIVE DAMAGES OF ANY KIND, OR FOR LOSS OF REVENUE OR PROFITS, LOSS OF BUSINESS, LOSS OF INFORMATION OR DATE, OR OTHER FINANCIAL LOSS ARISING OUT OF OR IN CONNECTION WITH THE SALE, INSTALLATION, MAINTENANCE, USE, PERFORMANCE, FAILURE, OR INTERRUPTION OF THE POSSIBILITY OF SUCH DAMAGES, AND LIMITS ITS LIABILITY TO REPAIR, REPLACEMENT, OR REFUND OF THE PURCHASE PRICE PAID, AT TRENDNET'S OPTION. THIS DISCLAIMER OF LIABILITY FOR DAMAGES WILL NOT BE AFFECTED IF ANY REMEDY PROVIDED HEREIN SHALL FAIL OF ITS ESSENTIAL PURPOSE.

**Governing Law:** This Limited Warranty shall be governed by the laws of the state of California.

Some TRENDnet products include software code written by third party developers. These codes are subject to the GNU General Public License ("GPL") or GNU Lesser General Public License ("LGPL").

Visit <http://www.trendnet.com/gpl> or the support section on <http://www.trendnet.com> and search for the desired TRENDnet product to access to the GPL Code or LGPL Code. These codes are distributed WITHOUT WARRANTY and are subject to the copyrights of the developers. TRENDnet does not provide technical support for these codes. Please visit <http://www.gnu.org/licenses/gpl.txt> or <http://www.gnu.org/licenses/lgpl.txt> for specific terms of each license.

PWP07172015v3

2016/12/12



## Product Warranty Registration

Please take a moment to register your product online.  
Go to TRENDnet's website at <http://www.trendnet.com/register>

TRENDnet  
20675 Manhattan Place  
Torrance, CA 90501. USA