



TRENDNET



User's Guide

TEW-435BRM

Table of Contents

CHAPTER 1 INTRODUCTION	1
54Mbps 802.11g ADSL Firewall Modem Router Features.....	2
Package Contents.....	4
Physical Details.....	5
CHAPTER 2 INSTALLATION	7
Requirements.....	7
Procedure	8
CHAPTER 3 SETUP	10
Overview.....	10
Configuration Program	11
Setup Wizard.....	12
Configuring VC2, VC3 and VC4.....	15
Home Screen.....	18
LAN Screen.....	21
Wireless Screen	24
Wireless Security.....	29
Trusted Wireless Stations.....	33
Password Screen.....	35
Mode Screen	37
CHAPTER 4 PC CONFIGURATION	38
Overview.....	38
Windows Clients.....	38
Macintosh Clients.....	49
Linux Clients	49
Other Unix Systems.....	49
Wireless Station Configuration	50
Wireless Configuration on Windows XP	50
CHAPTER 5 OPERATION AND STATUS	60
Operation - Router Mode	60
Status Screen.....	60
Connection Status - PPPoE & PPPoA	65
Connection Details - Dynamic IP Address	66
Connection Details - Fixed IP Address.....	67
Connection Details - BPA (Telstra Big Pond)	68
CHAPTER 6 ADVANCED FEATURES	69
Overview.....	69
Internet.....	69
Dynamic DNS (Domain Name Server).....	75
Firewall Rules.....	77
Services	83
Options	86
Schedule.....	87
Virtual Servers	91
CHAPTER 7 ADVANCED ADMINISTRATION	94
Overview.....	94
PC Database.....	95
Config File	101
Logs	103
E-mail	107
Diagnostics	109

Remote Administration	111
Routing	113
Upgrade Firmware	118
CHAPTER 8 MODEM MODE	119
Overview	119
Management Connections	119
Home Screen	120
Mode Screen	121
ADSL Screen	122
Operation	122
Status Screen	123
APPENDIX A TROUBLESHOOTING	125
Overview	125
General Problems	125
Internet Access	125
Wireless Access	126
APPENDIX B ABOUT WIRELESS LANS	128
Modes	128
BSS/ESS	128
Channels	129
WEP	129
WPA-PSK	129
Wireless LAN Configuration	130
APPENDIX C SPECIFICATIONS	131
Multi-Function Wireless ADSL/Modem Router	131
Wireless Interface	131
Regulatory Approvals	132

P/N: ~~9560LB0001~~

956YBM0037

Copyright © 2006. All Rights Reserved.

Document Version: ~~1.32~~1.0

All trademarks and trade names are the properties of their respective owners.

Chapter 1 Introduction

1

This Chapter provides an overview of the 54Mbps 802.11g ADSL Firewall Modem Router's features and capabilities.

Congratulations on the purchase of your new 54Mbps 802.11g ADSL Firewall Modem Router. The 54Mbps 802.11g ADSL Firewall Modem Router is a multi-function device providing the following services:

- **ADSL Modem.**
- **Shared Broadband Internet Access** for all LAN users.
- **Wireless Access Point** for 802.11b and 802.11g Wireless Stations.
- **4-Port Switching Hub** for 10BaseT or 100BaseT connections.

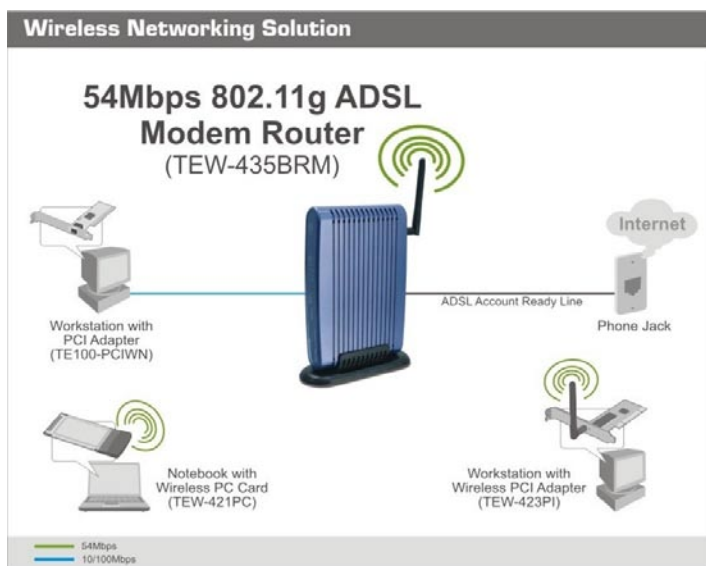

Wireless LAN



Figure 1: 54Mbps 802.11g ADSL Firewall Modem Router

54Mbps 802.11g ADSL Firewall Modem Router Features

The 54Mbps 802.11g ADSL Firewall Modem Router incorporates many advanced features, carefully designed to provide sophisticated functions while being easy to use.

Internet Access Features

- **Shared Internet Access.** All users on the LAN or WLAN can access the Internet through the 54Mbps 802.11g ADSL Firewall Modem Router, using only a single external IP Address. The local (invalid) IP Addresses are hidden from external sources. This process is called NAT (Network Address Translation).
- **Built-in ADSL Modem.** The 54Mbps 802.11g ADSL Firewall Modem Router has a built-in ADSL modem, supporting all common ADSL connections.
- **IPoA, PPPoE, PPPoA, BPA, Direct Connection Support.** The 54Mbps 802.11g ADSL Firewall Modem Router supports all common connection methods.
- **Auto-detection of Internet Connection Method.** [In most situations,](#) the 54Mbps 802.11g ADSL Firewall Modem Router can test your ADSL and Internet connection to determine the connection method used by your ISP. [This will require ISP or network service provider to enable F5 function in the CO side.](#)
- **Fixed or Dynamic IP Address.** On the Internet (ADSL port) connection, the 54Mbps 802.11g ADSL Firewall Modem Router supports both Dynamic IP Address (IP Address is allocated on connection) and Fixed IP Address.

Advanced Internet Functions

- **Application Level Gateways (ALGs).** Applications which use non-standard connections or port numbers are normally blocked by the Firewall. The ability to define and allow such applications is provided, to enable such applications to be used normally.
- **Special Applications.** This feature, also called Port Triggering, allows you to use Internet applications which normally do not function when used behind a firewall.
- **Virtual Servers.** This feature allows Internet users to access Internet servers on your LAN. The required setup is quick and easy.
- **Dynamic DNS Support.** DDNS, when used with the Virtual Servers feature, allows users to connect to Servers on your LAN using a Domain Name, even if you have a dynamic IP address which changes every time you connect.
- **URL Filter.** Use the URL Filter to block access to undesirable Web sites by LAN users.
- **Firewall.** As well as the built-in firewall to protect your LAN, you can define Firewall Rules to determine which incoming and outgoing traffic should be permitted.
- **Scheduling.** Both the URL Filter and Firewall rules can be scheduled to operate only at certain times. This provides great flexibility in controlling Internet -bound traffic.
- **Logs.** Define what data is recorded in the Logs, and optionally send log data to a Syslog Server. Log data can also be E-mailed to you.

Wireless Features

- **Standards Compliant.** The 54Mbps 802.11g ADSL Firewall Modem Router complies with the IEEE802.11g (DSSS) specifications for Wireless LANs.
- **Supports both 802.11b and 802.11g Wireless Stations.** The 802.11g standard provides for backward compatibility with the 802.11b standard, so both 802.11b and 802.11g Wireless stations can be used simultaneously.
- **Speeds to 54Mbps.** All speeds up to the 802.11g maximum of 54Mbps are supported.

- **WEP support.** Support for WEP (Wired Equivalent Privacy) is included. Key sizes of 64 Bit and 128 Bit are supported. WEP encrypts any data before transmission, providing protection against snoopers.
- **WPA support.** Support for WPA is included. WPA is more secure than WEP, and should be used if possible. Both TKIP and AES encryption methods are supported.
- **Wireless MAC Access Control.** The Wireless Access Control feature can check the MAC address (hardware address) of Wireless stations to ensure that only trusted Wireless Stations can access your LAN.
- **Simple Configuration.** If the default settings are unsuitable, they can be changed quickly and easily.

LAN Features

- **4-Port Switching Hub.** The 54Mbps 802.11g ADSL Firewall Modem Router incorporates a 4-port 10/100BaseT switching hub, making it easy to create or extend your LAN.
- **DHCP Server Support.** Dynamic Host Configuration Protocol provides a dynamic IP address to PCs and other devices upon request. The 54Mbps 802.11g ADSL Firewall Modem Router can act as a **DHCP Server** for devices on your local LAN and WLAN.

Configuration & Management

- **Easy Setup.** Use your WEB browser from anywhere on the LAN or WLAN for configuration.
- **Configuration File Upload/Download.** Save (download) the configuration data from the 54Mbps 802.11g ADSL Firewall Modem Router to your PC, and restore (upload) a previously-saved configuration file to the 54Mbps 802.11g ADSL Firewall Modem Router.
- **Remote Management.** The 54Mbps 802.11g ADSL Firewall Modem Router can be managed from any PC on your LAN or Wireless LAN. And, if the Internet connection exists, it can also (optionally) be configured via the Internet.
- **Network Diagnostics.** You can use the 54Mbps 802.11g ADSL Firewall Modem Router to perform a *Ping* or *DNS lookup*.

Security Features

- **Password - protected Configuration.** Password protection is provided to prevent unauthorized users from modifying the configuration data and settings.
- **Wireless LAN Security.** WPA-PSK, WEP and Wireless access control by MAC address are all supported. The MAC-level access control feature can be used to prevent unknown wireless stations from accessing your LAN.
- **NAT Protection.** An intrinsic side effect of NAT (Network Address Translation) technology is that by allowing all LAN users to share a single IP address, the location and even the existence of each PC is hidden. From the external viewpoint, there is no network, only a single device - the 54Mbps 802.11g ADSL Firewall Modem Router.
- **Firewall.** All incoming data packets are monitored and all incoming server requests are filtered, thus protecting your network from malicious attacks from external sources.
- **Protection against DoS attacks.** DoS (Denial of Service) attacks can flood your Internet connection with invalid packets and connection requests, using so much bandwidth and so many resources that Internet access becomes unavailable. The 54Mbps 802.11g ADSL Firewall Modem Router incorporates protection against DoS attacks.

Package Contents

The following items should be included. If any of these items are damaged or missing, please contact your dealer immediately.

- The 54Mbps 802.11g ADSL Firewall Modem Router Unit
- 1 Cat-5 Ethernet (LAN) cable (Gray Color)
- 1 RJ-11 (ADSL) cable (White Color)
- Power Adapter
- Quick Installation Guide
- CD-ROM containing the on-line manual.

Physical Details

Front-mounted LEDs



Figure 2: Front Panel

- Power LED (Green)** **On** - Power on.
 Off - No power.
- Status LED (Yellow)** **Off** - Normal operation.
 Blinking - This LED blinks during start up, and during a Firmware Upgrade.
- LAN** For each port, there are 2 LEDs, to indicate the connection speed (10BaseT or 100BaseT) of each port.
- **100BT** - This will be ON if the LAN connection is using 100BaseT, and Blinking if data is being transferred via the corresponding LAN port.
 - **10BT** - This will be ON if the LAN connection is using 10BaseT, and Blinking if data is being transferred via the corresponding LAN port.
 - If neither LED is on, there is no active connection on the corresponding LAN port.
- ADSL** **On** - ADSL connection established.
 Off - No ADSL connection currently exists.
 Flashing – ADSL is synchronizing.
- WLAN** **On** - Wireless enabled.
 Off - No Wireless connections currently exist.
 Flashing - Data is being transmitted or received via the Wireless access point. This includes "network traffic" as well as user data.
- Internet** **On** - Internet connection is available.
 Off - No Internet connection available.
 Flashing - Data is being transmitted or received via the ADSL connection.

Rear Panel



Figure 3: Rear Panel

ADSL port

Connect this port to your ADSL line.

**10/100BaseT
LAN connections**

Use standard LAN cables (RJ45 connectors) to connect your PCs to these ports.

Note:

Any LAN port on the 54Mbps 802.11g ADSL Firewall Modem Router will automatically function as an "Uplink" port when required. Just connect any port to a normal port on the other hub, using a standard LAN cable.

**Reset Button
(Reset to Defaults)**

This button will reset the 54Mbps 802.11g ADSL Firewall Modem Router to the factory default settings.

To do this, press and hold the Reset Button for five (5) seconds, until the Status LED is lit, then release the Reset Button, and wait the 54Mbps 802.11g ADSL Firewall Modem Router to restart using the factory default values.

Power port

Connect the supplied power adapter here.

Chapter 2

Installation



This Chapter covers the physical installation of the 54Mbps 802.11g ADSL Firewall Modem Router.

Requirements

- Network cables. Use standard 10/100BaseT network (UTP) cables with RJ45 connectors.
- TCP/IP protocol must be installed on all PCs.
- For Internet Access, an Internet Access account with an ISP, and a DSL connection.
- To use the Wireless Access Point, all Wireless devices must be compliant with the IEEE 802.11g or IEEE 802.11b specifications.

Procedure

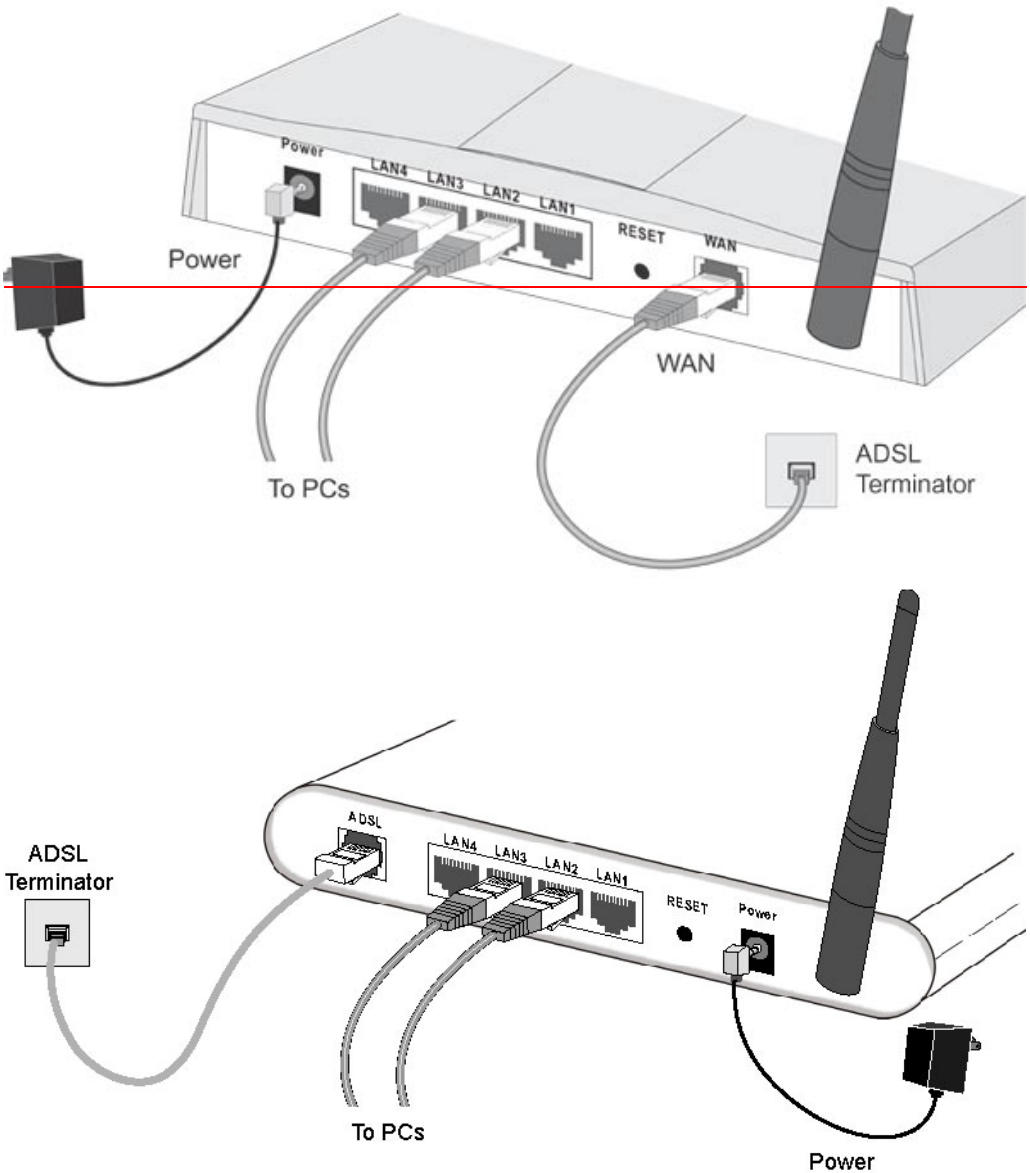

Figure 4: Installation Diagram

1. Choose an Installation Site

Select a suitable place on the network to install the 54Mbps 802.11g ADSL Firewall Modem Router.



Note!

For best Wireless reception and performance, the 54Mbps 802.11g ADSL Firewall Modem Router should be positioned in a central location with minimum obstructions between the 54Mbps 802.11g ADSL Firewall Modem Router and the PCs.

Also, if using multiple Access Points, adjacent Access

Points should use different Channels.

2. Connect LAN Cables

Use standard LAN cables to connect PCs to the Switching Hub ports on the 54Mbps 802.11g ADSL Firewall Modem Router. Both 10BaseT and 100BaseT connections can be used simultaneously.

If required, connect any port to a normal port on another Hub, using a standard LAN cable. Any LAN port on the 54Mbps 802.11g ADSL Firewall Modem Router will automatically function as an "Uplink" port when required.

3. Connect ADSL Cable

Connect the supplied ADSL cable from to the ADSL port on the 54Mbps 802.11g ADSL Firewall Modem Router (the RJ11 connector) to the ADSL terminator provided by your phone company.

4. Power Up

Connect the supplied power adapter to the 54Mbps 802.11g ADSL Firewall Modem Router. Use only the power adapter provided. Using a different one may cause hardware damage.

5. Check the LEDs

- The *Power* LED should be ON.
- The *Status* LED should flash, then turn Off. If it stays on or blinking after 60 seconds, there is a hardware error.
- For each LAN (PC) connection, one of the LAN LEDs should be ON (provided the PC is also ON.)
- The *WLAN* LED should be ON
- The *ADSL* LED should be ON if ADSL line is connected.
- The *Internet* LED may be OFF. After configuration, it should come ON.

For more information, refer to *Front-mounted LEDs* in Chapter 1.

Chapter 3 Setup

3

This Chapter provides Setup details of the 54Mbps 802.11g ADSL Firewall Modem Router.

Overview

This chapter describes the setup procedure for:

- Internet Access
- LAN configuration
- Wireless setup
- Assigning a Password to protect the configuration data.

PCs on your local LAN may also require configuration. For details, see *Chapter 4 - PC Configuration*.

Other configuration may also be required, depending on which features and functions of the 54Mbps 802.11g ADSL Firewall Modem Router you wish to use. Use the table below to locate detailed instructions for the required functions.

To Do this:	Refer to:
Configure PCs on your LAN.	Chapter 4: PC Configuration
Check 54Mbps 802.11g ADSL Firewall Modem Router operation and Status.	Chapter 5: Operation and Status
Use any of the following Advanced features: <ul style="list-style-type: none">• Internet (DMZ, Special Applications, URL Filter)• Dynamic DNS• Firewall Rules and• Firewall Services• Options• Scheduling Schedule• URL Filter• Virtual Servers (Port Forwarding)	Chapter 6: Advanced Features

<p>Use any of the following Administration Configuration settings or features:</p> <ul style="list-style-type: none"> • <u>PC Database</u> • Config File download/upload • Logssand • <u>E-mailing of logs and alerts</u> • Network-Diagnostics (Ping, DNS Lookup) • PC Database • Remote ManagementAdmin • Routing (RIP and static Routing) • Firmware Upgrade <u>Firmware</u> 	<p>Chapter 7 Advanced Administration</p>
---	--

Configuration Program

The 54Mbps 802.11g ADSL Firewall Modem Router contains an HTTP server. This enables you to connect to it, and configure it, using your Web Browser. **Your Browser must support JavaScript.**

The configuration program has been tested on the following browsers:

- Netscape 7.1 or later.
- Mozilla 1.6 or later
- Internet Explorer V5.5 or later

Preparation

Before attempting to configure the 54Mbps 802.11g ADSL Firewall Modem Router, please ensure that:

- Your PC can establish a physical connection to the 54Mbps 802.11g ADSL Firewall Modem Router. The PC and the 54Mbps 802.11g ADSL Firewall Modem Router must be directly connected (using the Hub ports on the 54Mbps 802.11g ADSL Firewall Modem Router) or on the same LAN segment.
- The 54Mbps 802.11g ADSL Firewall Modem Router must be installed and powered ON.
- If the 54Mbps 802.11g ADSL Firewall Modem Router's default IP Address (192.168.0.1) is already used by another device, the other device must be turned OFF until the 54Mbps 802.11g ADSL Firewall Modem Router is allocated a new IP Address during configuration.

Using your Web Browser

To establish a connection from your PC to the 54Mbps 802.11g ADSL Firewall Modem Router:

1. After installing the 54Mbps 802.11g ADSL Firewall Modem Router in your LAN, start your PC. If your PC is already running, restart it.
2. Start your WEB browser.
3. In the *Address* box, enter "HTTP://" and the IP Address of the 54Mbps 802.11g ADSL Firewall Modem Router, as in this example, which uses the 54Mbps 802.11g ADSL Firewall Modem Router's default IP Address:

HTTP://192.168.0.1

4. When prompted for the User name and Password, enter values as follows:

- User name admin
- Password password

If you can't connect

If the 54Mbps 802.11g ADSL Firewall Modem Router does not respond, check the following:

- The 54Mbps 802.11g ADSL Firewall Modem Router is properly installed, LAN connection is OK, and it is powered ON. You can test the connection by using the "Ping" command:
 - Open the MS-DOS window or command prompt window.
 - Enter the command:
`ping 192.168.0.1`
If no response is received, either the connection is not working, or your PC's IP address is not compatible with the 54Mbps 802.11g ADSL Firewall Modem Router's IP Address. (See next item.)
- If your PC is using a fixed IP Address, its IP Address must be within the range 192.168.0.2 to 192.168.0.254 to be compatible with the 54Mbps 802.11g ADSL Firewall Modem Router's default IP Address of 192.168.0.1. Also, the *Network Mask* must be set to 255.255.255.0. See *Chapter 4 - PC Configuration* for details on checking your PC's TCP/IP settings.
- Ensure that your PC and the 54Mbps 802.11g ADSL Firewall Modem Router are on the same network segment. (If you don't have a router, this must be the case.)
- Ensure you are using the wired LAN interface. The Wireless interface can only be used if its configuration matches your PC's wireless settings.

Setup Wizard

The first time you connect to the 54Mbps 802.11g ADSL Firewall Modem Router, you should run the *Setup Wizard* to configure the ADSL and Internet Connection.

1. Click the *Setup Wizard* link on the main menu
2. On the first screen, select *VC 1 (Router - Primary Internet Connection)*, then click "Next"

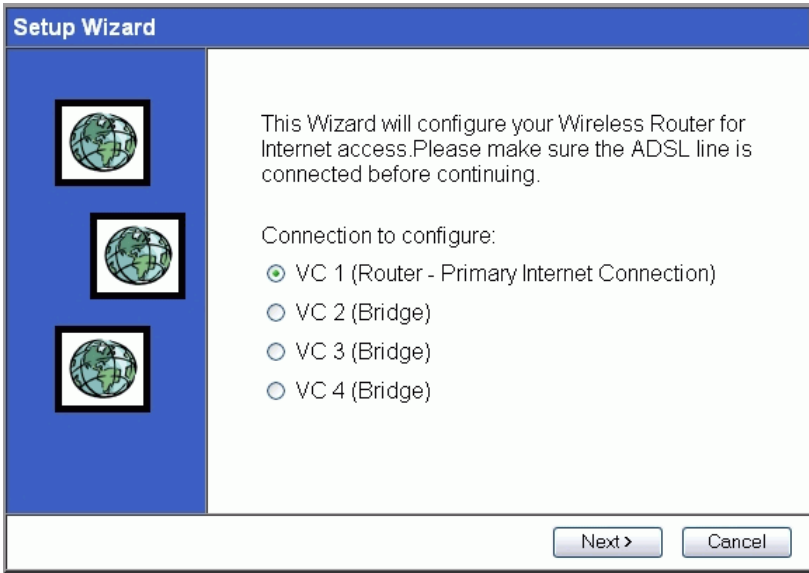

Figure 5: Setup Wizard Home Page

3. On the VC1 screen, shown below, enter the VPI and VCI values provided by your ISP, then click "Next".

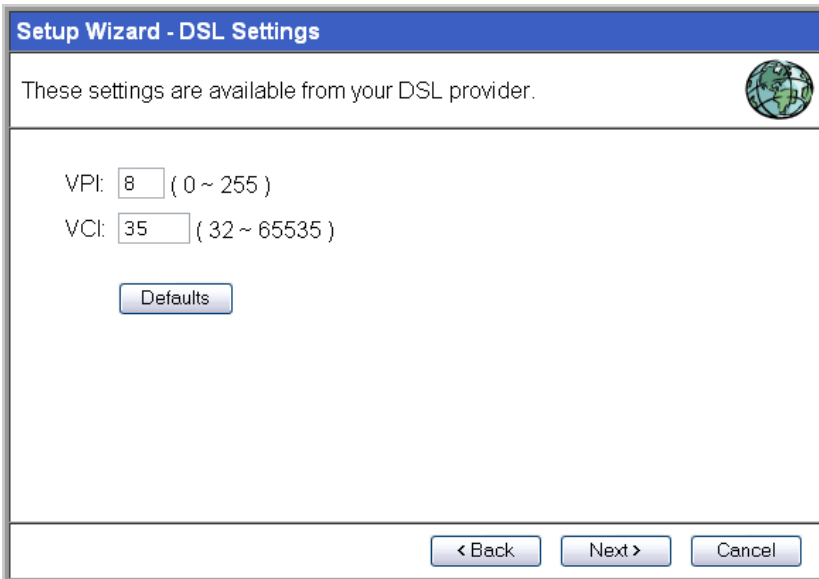

Figure 6: Setup Wizard - VC1

Setup Wizard - Internet Access

Check the data provided by your ISP.

Connection Method

If your ISP requires a User Name and Password for Internet Access, select "Login". Otherwise, select "No Login".

Login:

No Login:

DSL Multiplexing Method:

< Back Next > Cancel

Figure 7: Setup Wizard - Internet Access

4. On the Internet Access Screen, shown above, select the correct connection type, as used by your ISP. Click "Next" and complete the configuration for your connection method.
 - You need the data supplied by your ISP. Your ISP's data will also have the *DSL Multiplexing Method* (LLC or VC)
 - The common connection types are explained in the [following tables, below](#).

Common Connection Types

Common Connection Types

Connection Type	Details	ISP Data required
Dynamic IP Address	Your IP Address is allocated automatically, when you connect to you ISP.	Often, none. Some ISP's may require you to use a particular Hostname or Domain name, or MAC (physical) address.
Static (Fixed) IP Address	Your ISP allocates a permanent IP Address to you. Usually, the connection is "Always on".	IP Address allocated to you, and related information, such as Network Mask, Gateway IP address, and DNS address.
PPPoE, PPPoA	You connect to the ISP only when required. The IP address is usually allocated automatically.	a) User name and password are always required. b) If using a Static (Fixed) IP address, you need the IP address and related information (Network Mask, Gateway IP address, and DNS address)
IPoA (IP over ATM)	Normally, the connection is "Always on".	IP Address allocated to you, and related information, such as Network Mask, Gateway IP address, and DNS address.
BPA	BPA is mainly used in Australia.	<ul style="list-style-type: none"> • Server IP Address. • User name and password. • Big Pond Server IP address

4.5. Step through the Wizard until finished.

2.6. On the final screen of the Wizard, run the test and check that an Internet connection can be established.

3.7. If the connection test fails:

- Check all connections, and the front panel LEDs.
- Check that you have entered all data correctly.

Configuring VC2, VC3 and VC4

The 54Mbps 802.11g ADSL Firewall Modem Router supports multiple VCs (Virtual Circuits) on the ADSL connection.

VC1 must be used for general-purpose Internet access. The other VCs (VC2, VC3 and VC4) are available for special purposes, such as Video-on-Demand.

You can only use these VCs if supported by your ISP and ADSL service provider. In that case, they will provide the necessary configuration data.



Some ISP's allow multiple PPPoE connections. This allows multiple PCs to connect to the Internet using PPPoE client software. When using the 54Mbps 802.11g ADSL Firewall Modem Router, multiple PPPoE connections are neither necessary nor supported.

To Configure additional VCs

1. Start the *Setup Wizard* again.
2. On the first screen, select VC2, and click "Next"
3. Configure the VC setup screen as described below, then click "Next".

Figure 8: Setup Wizard - VC2

Setup Wizard VC Screen

VC	The VC number is displayed (VC2, VC3, or VC4)
Enable	To use this VC, you must enable it by checking this checkbox.
VPI	Enter the VPI value provided by your ISP.
VCI	Enter the VPI value provided by your ISP.
Multiplexing	Select the multiplexing value provided by your ISP.
ATM Service	Select the multiplexing value provided by your ISP.

IP Address	Enter the IP address of the device on your LAN which will receive the data on this VC. <ul style="list-style-type: none">• For Video-on-Demand, this would be the IP address of your SetTop Box.• For VoIP, this would be the IP address of your VoIP TA.• Note that this IP address does not have to be in the same IP address range as other devices on your local LAN.
-------------------	---

4. When finished, click "Next" and complete the Wizard.
5. After completing the Wizard, you can check the Status screen to see the VC has been corrected established.

Home Screen

After finishing the Setup Wizard, you will see the *Home* screen. When you connect in future, you will see this screen when you connect. An example screen is shown below.



TEW-435BRM
Router Setup

- Setup Wizard
- LAN
- Wireless
- Password
- Mode
- Status
- ▼ Advanced
- ▼ Administration

Log Out

Restart

Wireless Router



TEW-435BRM (ANNEX A)		
Internet:	IP Address:	---
	Connection Method:	IPOA
Wireless:	SSID:	default
	Security:	Disabled
LAN:	IP Address:	192.168.0.1
	DHCP Server:	On

Router Setup

- Setup Wizard
- LAN
- Wireless
- Password
- Status
- ▼ Advanced
- ▼ Administration

Log Out

Restart

Wireless Router

ADSL Router (ANNEX A)		
Internet:	IP Address:	---
	Connection Method:	PPPOE
Wireless:	SSID:	wireless
	WEP:	Disabled
LAN:	IP Address:	192.168.0.1
	DHCP Server:	On

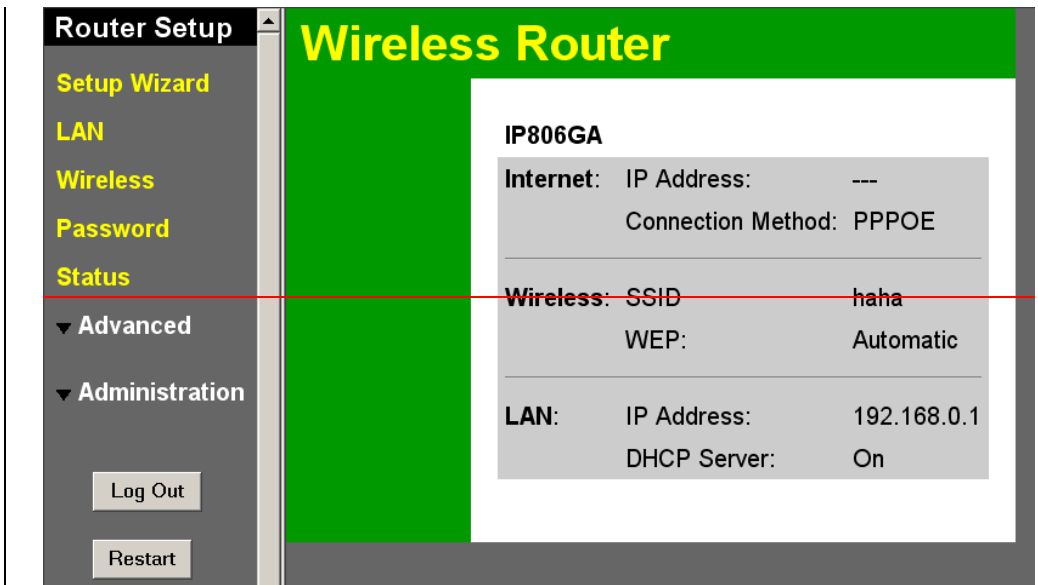

Figure 9: Home Screen

Main Menu

The main menu, on the left, contains links to the most-commonly used screen. To see the links to the other available screens, click "Advanced" or "Administration".

The main menu also contains two (2) buttons:

- **Log Out** - When finished, you should click this button to logout.
- **Restart** - Use this if you wish to restart the 54Mbps 802.11g ADSL Firewall Modem Router. Note that restarting the Router will break any existing connections to or through the Router.

Navigation & Data Input

- Use the menu bar on the left of the screen, and the "Back" button on your Browser, for navigation.
- Changing to another screen without clicking "Save" does NOT save any changes you may have made. You must "Save" before changing screens or your data will be ignored.



On each screen, clicking the "Help" button will display help for that screen.

LAN Screen

Use the *LAN* link on the main menu to reach the LAN screen. An example screen is shown below.

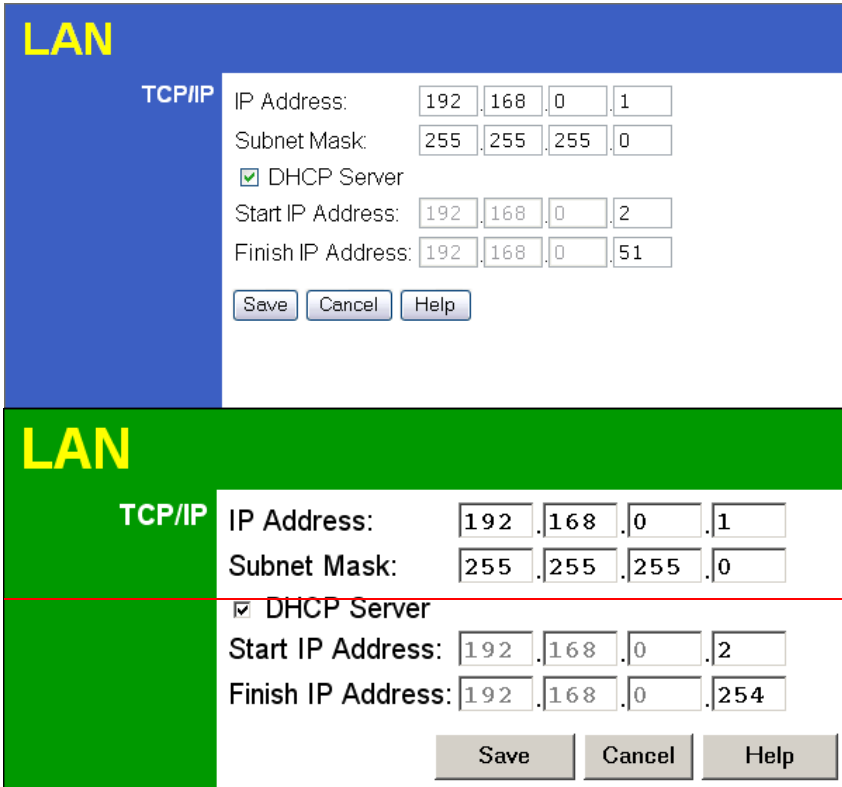

Figure 10: LAN Screen

Data - LAN Screen

TCP/IP	
IP Address	IP address for the 54Mbps 802.11g ADSL Firewall Modem Router, as seen from the local LAN. Use the default value unless the address is already in use or your LAN is using a different IP address range. In the latter case, enter an unused IP Address from within the range used by your LAN.
Subnet Mask	The default value 255.255.255.0 is standard for small (class "C") networks. For other networks, use the Subnet Mask for the LAN segment to which the 54Mbps 802.11g ADSL Firewall Modem Router is attached (the same value as the PCs on that LAN segment).

DHCP Server

- If Enabled, the 54Mbps 802.11g ADSL Firewall Modem Router will allocate IP Addresses to PCs (DHCP clients) on your LAN when they start up. The default (and recommended) value is Enabled.
- If you are already using a DHCP Server, this setting must be Disabled, and the existing DHCP server must be re-configured to treat the 54Mbps 802.11g ADSL Firewall Modem Router as the default Gateway. See the following section for further details.
- The **Start IP Address** and **Finish IP Address** fields set the values used by the DHCP server when allocating IP Addresses to DHCP clients. This range also determines the number of DHCP clients supported.

See the following section for further details on using DHCP.

DHCP

What DHCP Does

A DHCP (Dynamic Host Configuration Protocol) **Server** allocates a valid IP address to a DHCP **Client** (PC or device) upon request.

- The client request is made when the client device starts up (boots).
- The DHCP Server provides the *Gateway* and *DNS* addresses to the client, as well as allocating an IP Address.
- The 54Mbps 802.11g ADSL Firewall Modem Router can act as a **DHCP server**.
- Windows 95/98/ME and other non-Server versions of Windows will act as a DHCP **client**. This is the default Windows setting for the TCP/IP network protocol. However, Windows uses the term *Obtain an IP Address automatically* instead of "DHCP Client".
- You must NOT have two (2) or more DHCP Servers on the same LAN segment. (If your LAN does not have other Routers, this means there must only be one (1) DHCP Server on your LAN.)

Using the 54Mbps 802.11g ADSL Firewall Modem Router's DHCP Server

This is the default setting. The DHCP Server settings are on the *LAN* screen. On this screen, you can:

- Enable or Disable the 54Mbps 802.11g ADSL Firewall Modem Router's *DHCP Server* function.
- Set the range of IP Addresses allocated to PCs by the DHCP Server function.



Note!

You can assign Fixed IP Addresses to some devices while using DHCP, provided that the Fixed IP Addresses are NOT within the range used by the DHCP Server.

Using another DHCP Server

You can only use one (1) DHCP Server per LAN segment. If you wish to use another DHCP Server, rather than the 54Mbps 802.11g ADSL Firewall Modem Router's, the following procedure is required.

1. Disable the DHCP Server feature in the 54Mbps 802.11g ADSL Firewall Modem Router. This setting is on the LAN screen.
2. Configure the DHCP Server to provide the 54Mbps 802.11g ADSL Firewall Modem Router's IP Address as the *Default Gateway*.

To Configure your PCs to use DHCP

This is the default setting for TCP/IP for all non-Server versions of Windows.

See *Chapter 4 - Client Configuration* for the procedure to check these settings.

Wireless Screen

The 54Mbps 802.11g ADSL Firewall Modem Router's settings must match the other Wireless stations.

Note that the 54Mbps 802.11g ADSL Firewall Modem Router will automatically accept both 802.11b and 802.11g connections, and no configuration is required for this feature.

To change the 54Mbps 802.11g ADSL Firewall Modem Router's default settings for the Wireless Access Point feature, use the *Wireless* link on the main menu to reach the ***Wireless*** screen. An example screen is shown below.

Wireless

Identification	Region:	<input type="text" value="— Select Region —"/>
	Station Name:	TEW-435BRM (ANNEX A)
	SSID (Service Set Identifier)	<input type="text" value="default"/>
Options	802.11 Mode:	<input type="text" value="802.11g & 802.11b"/>
	Channel No:	<input type="text" value="11"/>
	<input checked="" type="checkbox"/> Broadcast SSID	
Wireless Security	Current Setting:	Disabled
		<input type="button" value="Configure"/>
Access Point	<input checked="" type="checkbox"/> Enable Wireless Access Point	
	Allow access by:	
	<input checked="" type="radio"/> ALL Wireless stations	
	<input type="radio"/> Trusted Wireless stations only	<input type="button" value="Set Stations"/>
<input type="button" value="Save"/> <input type="button" value="Cancel"/> <input type="button" value="Help"/>		

Wireless

Identification	Region:	<input type="text" value="USA"/>
	Station Name:	ADSL Router (ANNEX A)
	SSID (Service Set Identifier)	<input type="text" value="wireless"/>
Options	Mode:	<input type="text" value="802.11g & 802.11b"/>
	Channel No:	<input type="text" value="11"/>
	<input checked="" type="checkbox"/> Broadcast SSID	
Access Point	WEP Encryption:	Disabled <input type="button" value="Configure WEP"/>
	<input checked="" type="checkbox"/> Enable Wireless Access Point	
	Allow access by:	
	<input checked="" type="radio"/> ALL Wireless stations	
<input type="radio"/> Trusted Wireless stations only	<input type="button" value="Set Stations"/>	
<input type="button" value="Save"/> <input type="button" value="Cancel"/> <input type="button" value="Help"/>		

Figure 11: Wireless Screen

Data - Wireless Screen

Identification	
Region	<p>Select the correct domain for your location. It is your responsibility to ensure:</p> <ul style="list-style-type: none"> • That the 54Mbps 802.11g ADSL Firewall Modem Router is only used in domains for which is licensed. • That you select the correct domain, so that only the legal channels for that domain can be selected.
Station name	<p>This is the same as the "Device Name" for the 54Mbps 802.11g ADSL Firewall Modem Router.</p>
SSID	<p>This is also called the "Network Name".</p> <ul style="list-style-type: none"> • If using an ESS (Extended Service Set, with multiple access points) this ID is called an ESSID (Extended Service Set Identifier). • To communicate, all Wireless stations should use the same SSID/ESSID.

Options	
Mode	<p>Select the desired mode:</p> <ul style="list-style-type: none"> • 802.11g & 802.11b - Both 802.11g and 802.11b Wireless stations will be able to use the 54Mbps 802.11g ADSL Firewall Modem Router. • 802.11g only - Only 802.11g Wireless stations can use the 54Mbps 802.11g ADSL Firewall Modem Router. • 802.11b only - Only 802.11b connections are available. 802.11g Wireless Stations will only be able to use the 54Mbps 802.11g ADSL Firewall Modem Router if they are fully backward-compatible with the 802.11b standard.
Channel No.	<p><input type="checkbox"/> Select the Channel you wish to use on your Wireless LAN.</p> <ul style="list-style-type: none"> • If you experience interference (shown by lost connections and/or slow data transfers) you may need to experiment with different channels to see which is the best. • If using multiple Access Points, adjacent Access Points should use different Channels to reduce interference.
Broadcast SSID	<p>If enabled, the 54Mbps 802.11g ADSL Firewall Modem Router will broadcast its SSID. This allows PCs and other wireless stations to detect this Access Point and use the correct SSID.</p> <p>If disabled, PC users will have to manually enter the SSID and other details of the wireless interface before they can connect to this Access Point.</p>
Wireless Security	
<u>Current Setting</u> WEP data encryption	<p><input type="checkbox"/> The current Wireless security is displayed. The default value is Disabled. WEP (Wired Equivalent Privacy) status will display "Disabled" if WEP is not being used, otherwise it will display "64 Bit" or "128 Bit" depending on the WEP key size being used. If WEP is used, data is Encrypted before being transmitted, making communication more secure.</p> <p><input type="checkbox"/> Click the "Configure WEP" button to access the WEP sub-screen, and view or change the WEP settings.</p>
<u>Configure WEP Button</u>	<p>Click this button <u>to access the Wireless security sub-screen, and view or change the settings. See the following section for details.</u> <u>to view the WEP sub-screen. See the following section for more details.</u></p>
Access Point	
Enable Wireless Access Point	<p>Enable this if you want to use Wireless Access Point function.</p> <p>If disabled, no Wireless stations can use the Access Point function, and all connections must be made via the wired LAN.</p>

Allow access by ...	Use this feature to determine which Wireless stations can use the Access Point. The options are: <ul style="list-style-type: none">• All Wireless Stations - All wireless stations can use the access point, provided they have the correct SSID and security settings.• Trusted Wireless stations only - Only wireless stations you designate as "Trusted" can use the Access Point, even if they have the correct SSID and security settings. This feature uses the MAC address to identify Wireless stations. The MAC address is a low-level network identifier which is unique to each PC or network device. To define the trusted wireless stations, use the "Set Stations" button.
Set Stations Button	Click this button to manage the trusted PC database.

Wireless Security

This screen is accessed by clicking the "Configure" button on the *Wireless* screen. There are 3 options for Wireless security:

- **Disabled** - no data encryption is used.
- **WEP** - data is encrypted using the WEP standard.
- **WPA-PSK** - data is encrypted using the WPA-PSK standard. This is a later standard than WEP, and provides much better security than WEP. If all your Wireless stations support WPA-PSK, you should use WPA-PSK rather than WEP.

WEP Wireless SecurityScreen

~~This screen is accessed by clicking the "Configure WEP" button on the *Wireless* screen.~~

Wireless Security

Security System

Authentication Type:

WEP Data Encryption:

Key 1:

Key 2:

Key 3:

Key 4:

Passphrase:

Wireless - WEP Data Encryption

WEP Data Encryption:

Authentication Type:

Default

Key	Key value
Key 1: <input checked="" type="radio"/>	<input type="text"/>
Key 2: <input type="radio"/>	<input type="text"/>
Key 3: <input type="radio"/>	<input type="text"/>
Key 4: <input type="radio"/>	<input type="text"/>

Keys must be entered in Hex (0-9 and A-F)

Passphrase:

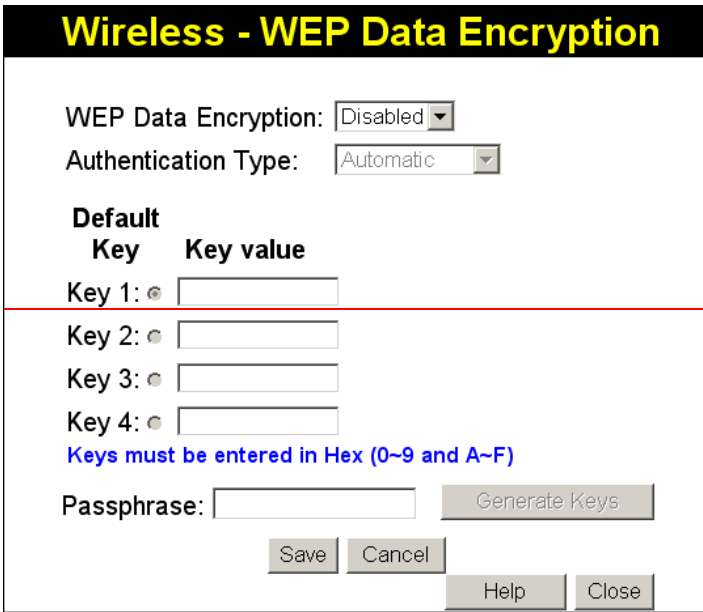

Figure 12: WEP-Screen

Data - WEP Screen

WEP Data Encryption	
Authentication Type	Normally, this should be left at the default value of "Automatic". If changed to "Open System" or "Shared Key", ensure that your Wireless Stations use the same setting.
WEP Data Encryption	Select the desired option, and ensure the Wireless Stations use the same setting. <ul style="list-style-type: none"> • 64 Bit - data is encrypted, using the default key, before being transmitted. You must enter at least the default key. For 64 Bit Encryption, the key size is 10 chars in HEX (0~9 and A~F). • 128 Bit - data is encrypted, using the default key, before being transmitted. You must enter at least the default key. For 128 Bit Encryption, the key size is 26 chars in HEX (0~9 and A~F).
Default Key	Select the key you wish to be the default. Transmitted data is ALWAYS encrypted using the Default Key; the other Keys are for decryption only. You must enter a Key Value for the Default Key .
Key Value	Enter the key value or values you wish to use. The Default Key is required, the other keys are optional. Other stations must have the same key.
Passphrase	If desired, you can generate a key from a phrase, instead of entering the key value directly. Enter the desired phrase, and click the "Generate Keys" button.

WPA-PSK Wireless Security

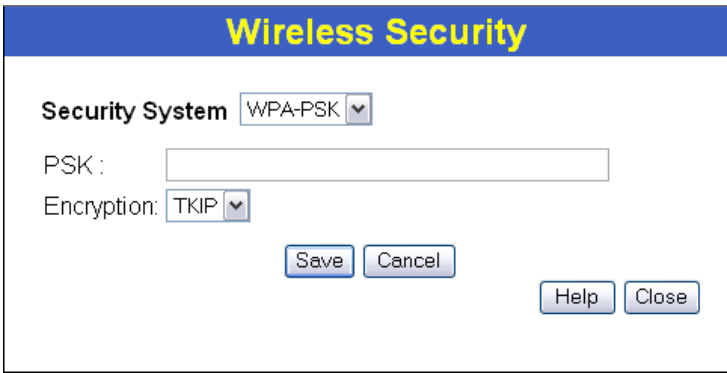

Figure 13: WPA-PSK

Data - WPA-PSK Screen

<p><u>Security System</u></p>	<p><u>WPA-PSK</u> <u>Like WEP, data is encrypted before transmission. WPA is more secure than WEP, and should be used if possible. WPA-PSK is the version of WPA, which does NOT require a Radius Server on your LAN.</u></p>
<p><u>PSK</u></p>	<p><u>Enter the PSK (network key). Data is encrypted using a key derived from the network key. Other Wireless Stations must use the same network key. The PSK must be from 8 to 63 characters in length.</u></p>
<p><u>Encryption</u></p>	<p><u>The WPA-PSK standard allows different encryption methods to be used. Select the desired option. Wireless Stations must use the same encryption method.</u></p>

Trusted Wireless Stations

This feature can be used to prevent unknown Wireless stations from using the Access Point. This list has no effect unless the setting *Allow access by trusted stations only* is enabled.

To change the list of trusted wireless stations, use the *Modify List* button on the *Access Control* screen. You will see a screen like the sample below.

Figure 14: Trusted Wireless Stations

Data - Trusted Wireless Stations

<u>Trusted Wireless Stations</u>	<u>This lists any Wireless Stations which you have designated as "Trusted".</u>
<u>Other Wireless Stations</u>	<u>This list any Wireless Stations detected by the Access Point, which you have not designated as "Trusted".</u>
<u>Name</u>	<u>The name assigned to the Trusted Wireless Station. Use this when adding or editing a Trusted Station.</u>
<u>Address</u>	<u>The MAC (physical) address of the Trusted Wireless Station. Use this when adding or editing a Trusted Station.</u>
<u>Buttons</u>	
<u><<</u>	<u>Add a Trusted Wireless Station to the list (move from the "Other Stations" list).</u> <ul style="list-style-type: none"> • <u>Select an entry (or entries) in the "Other Stations" list, and click the "<<" button.</u> • <u>Enter the Address (MAC or physical address) of the wireless station, and click the "Add" button.</u>
<u>>></u>	<u>Delete a Trusted Wireless Station from the list (move to the "Other Stations" list).</u> <ul style="list-style-type: none"> • <u>Select an entry (or entries) in the "Trusted Stations" list.</u> • <u>Click the ">>" button.</u>

<u>Edit</u>	Use this to <u>change an existing entry in the "Trusted Stations" list</u> : <ol style="list-style-type: none">1. <u>Select the Station in the <i>Trusted Station</i> list.</u>2. <u>Click the <i>Edit</i> button. The address will be copied to the "Address" field, and the <i>Add</i> button will change to <i>Update</i>.</u>3. <u>Edit the address (MAC or physical address) as required.</u>4. <u>Click <i>Update</i> to save your changes.</u>
<u>Add (Update)</u>	<u>To add a Trusted Station which is not in the "Other Wireless Stations" list, enter the required data and click this button.</u> When editing an existing Wireless Station, this button will change from <i>Add</i> to <i>Update</i> .
<u>Clear</u>	<u>Clear the <i>Name</i> and <i>Address</i> fields.</u>

Password Screen

The password screen allows you to assign a password to the 54Mbps 802.11g ADSL Firewall Modem Router.

Password

Password The password protects the configuration data. Once set (recommended), you will be prompted for the password when you connect.

Old Password

New password:

Verify password:

Password

Password The password protects the configuration data. Once set (recommended), you will be prompted for the password when you connect.

Old Password

New password:

Verify password:

Figure 15: Password Screen

Old Password	Enter the existing password in this field.
New password	Enter the new password here.
Verify password	Re-enter the new password here.

You will be prompted for the password when you connect, as shown below.

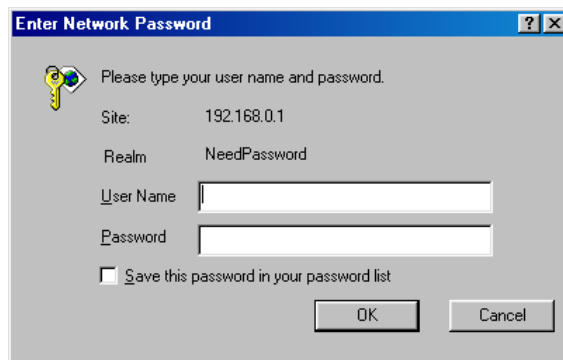

Figure 16: Password Dialog

- The "User Name" is always admin
- Enter the password for the 54Mbps 802.11g ADSL Firewall Modem Router, as set on the *Password* screen above.

Mode Screen

Use this screen to change the mode between Router mode and Modem (Bridge) mode.

Figure 17: Mode Screen

Select the desired option, and click "Save".

Router	<p><u>Both the ADSL Modem and the Router features are operational. In this mode, this device can provide shared Internet Access to all your LAN users. Also, by default, it acts a DHCP Server, providing an IP address and related information to all Wireless and LAN users.</u></p>
Modem	<p><u>Only the ADSL Modem component is operational.</u></p> <ul style="list-style-type: none"> • <u>All Router features are disabled. This device is "transparent" - it does not perform any operations or make any changes to the network traffic passing through it.</u> • <u>You need to have a DHCP Server on your LAN to provide IP addresses to the Wireless clients using this Access Point.</u> • All traffic received on either the Wireless or LAN interface will be sent over the ADSL connection.

Notes:

- Generally, you should NOT use modem mode. Only select this mode if you are sure this is what you want.
- After changing the mode, this device will restart, which will take a few seconds. The menu will also change, depending on the mode you are in.
- The Wireless Access Point can function in either Router or Modem mode. But generally it is not a good idea to combine a Modem with an Access Point, because all data received from the wireless stations will be sent over the modem connection. (Since the modem is transparent, it does not examine the traffic to determine whether the traffic is for the LAN or the WAN.)
- For details on using Modem Mode, see Chapter 8.

Chapter 4

PC Configuration

4

This Chapter details the PC Configuration required on the local ("Internal") LAN.

Overview

For each PC, the following may need to be configured:

- TCP/IP network settings
- Internet Access configuration
- Wireless configuration

Windows Clients

This section describes how to configure Windows clients for Internet access via the 54Mbps 802.11g ADSL Firewall Modem Router.

The first step is to check the PC's TCP/IP settings.

The 54Mbps 802.11g ADSL Firewall Modem Router uses the TCP/IP network protocol for all functions, so it is essential that the TCP/IP protocol be installed and configured on each PC.

TCP/IP Settings - Overview

If using the default 54Mbps 802.11g ADSL Firewall Modem Router settings, and the default Windows TCP/IP settings, no changes need to be made.

- By default, the 54Mbps 802.11g ADSL Firewall Modem Router will act as a DHCP Server, automatically providing a suitable IP Address (and related information) to each PC when the PC boots.
- For all non-Server versions of Windows, the default TCP/IP setting is to act as a DHCP client.

If using a Fixed (specified) IP address, the following changes are required:

- The *Gateway* must be set to the IP address of the 54Mbps 802.11g ADSL Firewall Modem Router
- The *DNS* should be set to the address provided by your ISP.



If your LAN has a Router, the LAN Administrator must re-configure the Router itself. Refer to *Chapter 8 - Advanced Setup* for details.

Checking TCP/IP Settings - Windows 9x/ME:

1. Select *Control Panel - Network*. You should see a screen like the following:

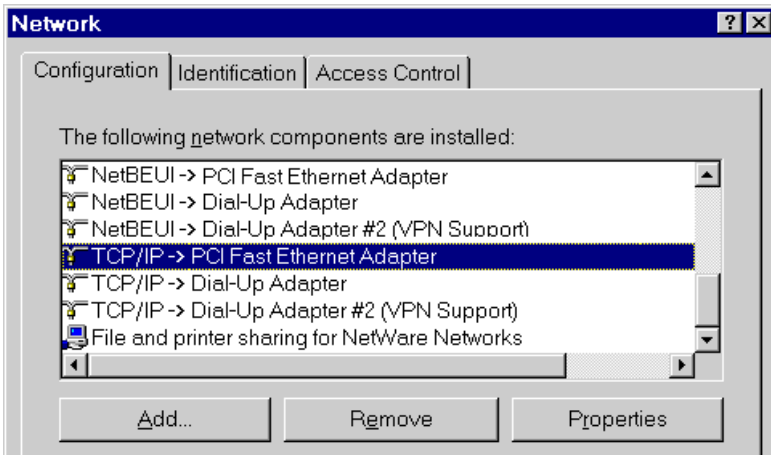

Figure 18: Network Configuration

2. Select the *TCP/IP* protocol for your network card.
3. Click on the *Properties* button. You should then see a screen like the following.

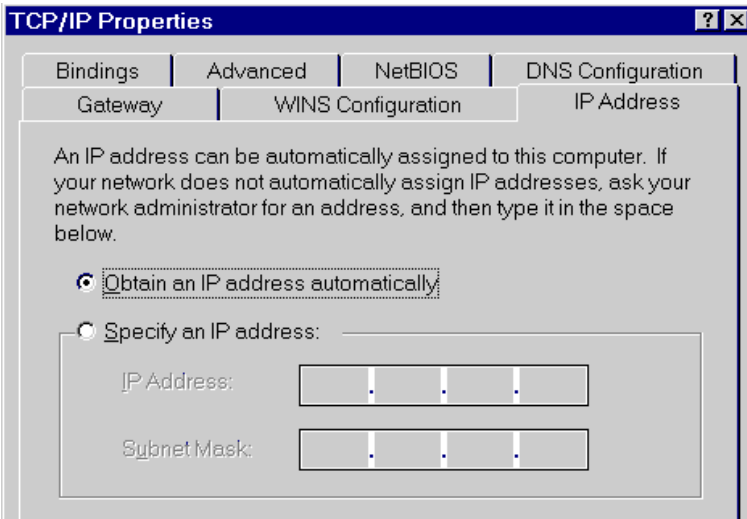

Figure 19: IP Address (Win 95)

Ensure your TCP/IP settings are correct, as follows:

Using DHCP

To use DHCP, select the radio button *Obtain an IP Address automatically*. This is the default Windows setting. **Using this is recommended.** By default, the 54Mbps 802.11g ADSL Firewall Modem Router will act as a DHCP Server.

Restart your PC to ensure it obtains an IP Address from the 54Mbps 802.11g ADSL Firewall Modem Router.

Using "Specify an IP Address"

If your PC is already configured, check with your network administrator before making the following changes:

- On the *Gateway* tab, enter the 54Mbps 802.11g ADSL Firewall Modem Router's IP address in the *New Gateway* field and click *Add*, as shown below. Your LAN administrator can advise you of the IP Address they assigned to the 54Mbps 802.11g ADSL Firewall Modem Router.

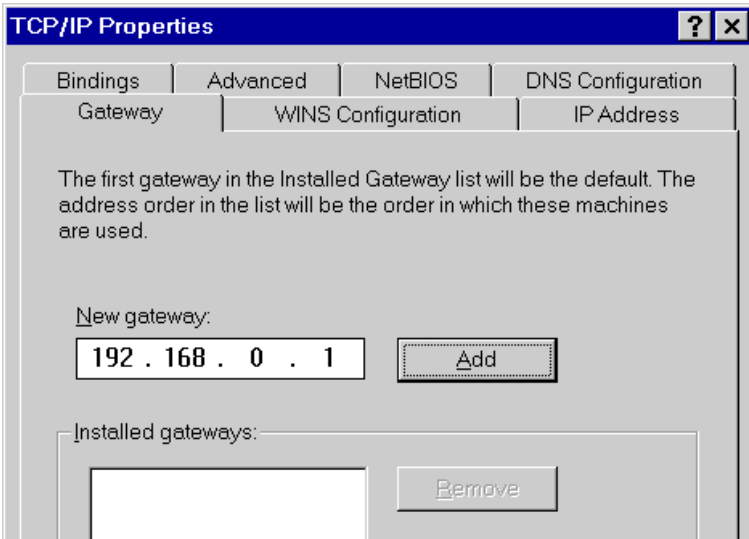

Figure 20: Gateway Tab (Win 95/98)

- On the *DNS Configuration* tab, ensure *Enable DNS* is selected. If the *DNS Server Search Order* list is empty, enter the DNS address provided by your ISP in the fields beside the *Add* button, then click *Add*.

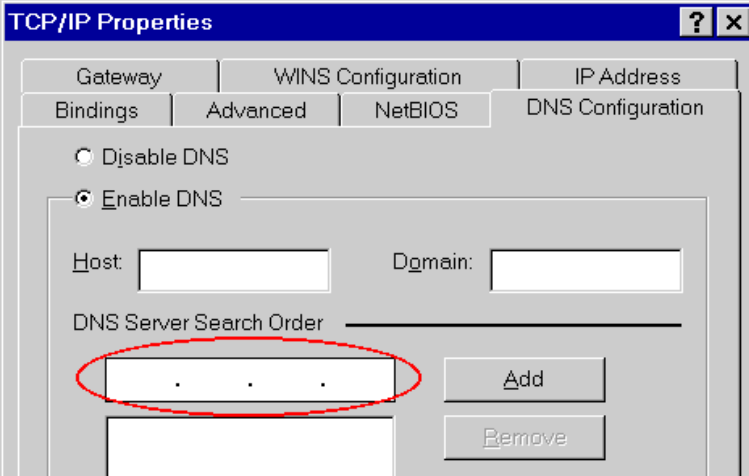

Figure 21: DNS Tab (Win 95/98)

Checking TCP/IP Settings - Windows NT4.0

1. Select *Control Panel - Network*, and, on the *Protocols* tab, select the TCP/IP protocol, as shown below.

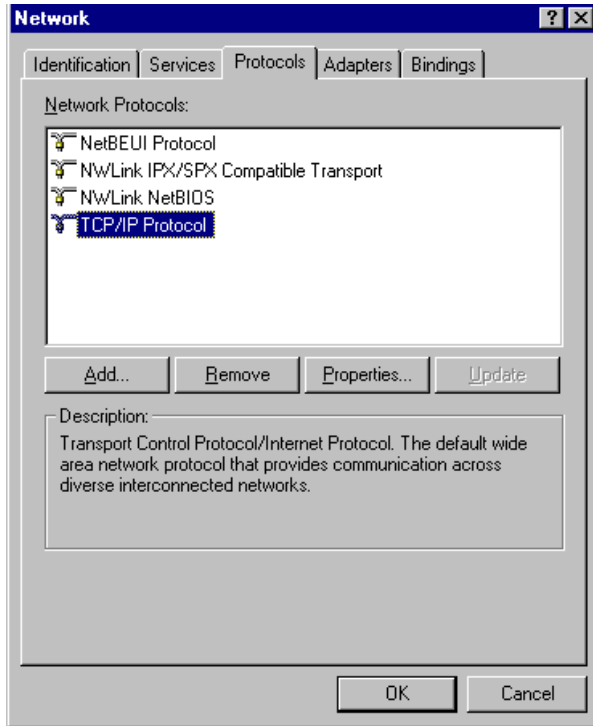

Figure 22: Windows NT4.0 - TCP/IP

2. Click the *Properties* button to see a screen like the one below.

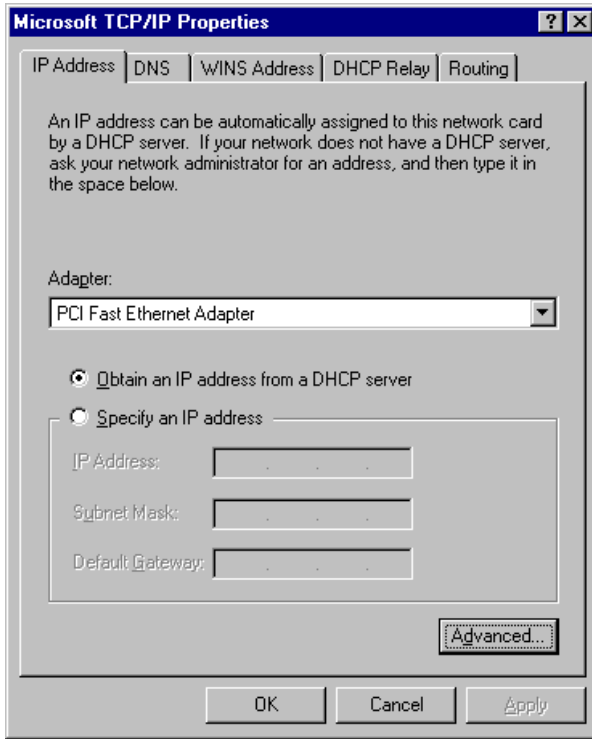

Figure 23: Windows NT4.0 - IP Address

3. Select the network card for your LAN.
4. Select the appropriate radio button - *Obtain an IP address from a DHCP Server* or *Specify an IP Address*, as explained below.

Obtain an IP address from a DHCP Server

This is the default Windows setting. **Using this is recommended.** By default, the 54Mbps 802.11g ADSL Firewall Modem Router will act as a DHCP Server.

Restart your PC to ensure it obtains an IP Address from the 54Mbps 802.11g ADSL Firewall Modem Router.

Specify an IP Address

If your PC is already configured, check with your network administrator before making the following changes.

1. The *Default Gateway* must be set to the IP address of the 54Mbps 802.11g ADSL Firewall Modem Router. To set this:
 - Click the *Advanced* button on the screen above.
 - On the following screen, click the *Add* button in the *Gateways* panel, and enter the 54Mbps 802.11g ADSL Firewall Modem Router's IP address, as shown in Figure 24 below.
 - If necessary, use the *Up* button to make the 54Mbps 802.11g ADSL Firewall Modem Router the first entry in the *Gateways* list.

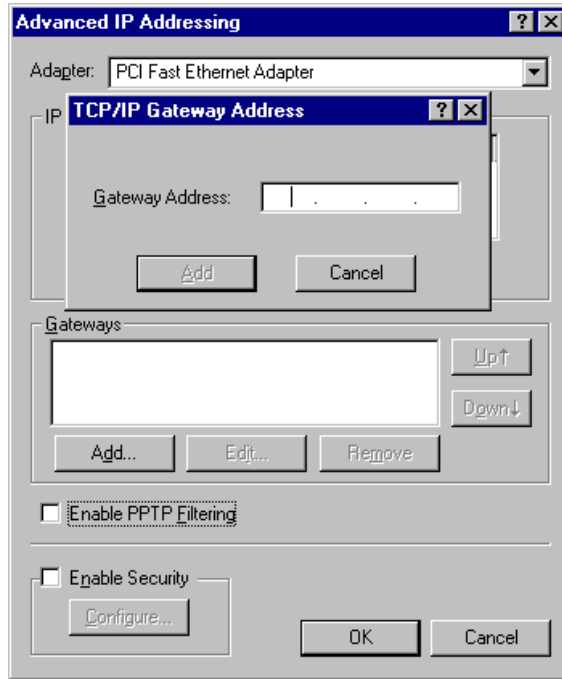

Figure 24 - Windows NT4.0 - Add Gateway

2. The DNS should be set to the address provided by your ISP, as follows:
 - Click the DNS tab.
 - On the DNS screen, shown below, click the *Add* button (under *DNS Service Search Order*), and enter the DNS provided by your ISP.

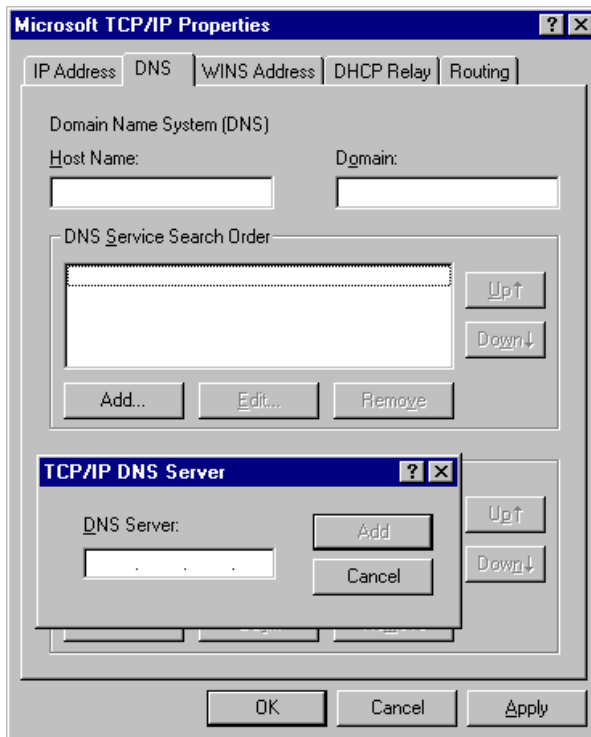

Figure 25: Windows NT4.0 - DNS

Checking TCP/IP Settings - Windows 2000:

1. Select *Control Panel - Network and Dial-up Connection*.
2. Right - click the *Local Area Connection* icon and select *Properties*. You should see a screen like the following:

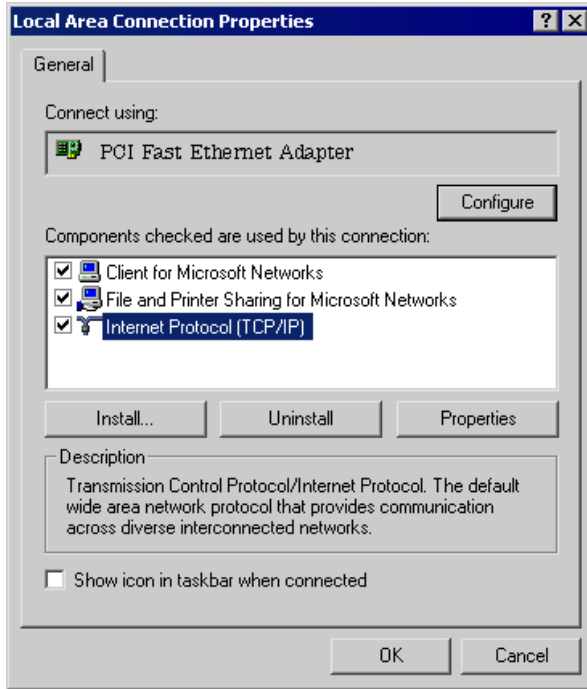

Figure 26: Network Configuration (Win 2000)

3. Select the *TCP/IP* protocol for your network card.
4. Click on the *Properties* button. You should then see a screen like the following.

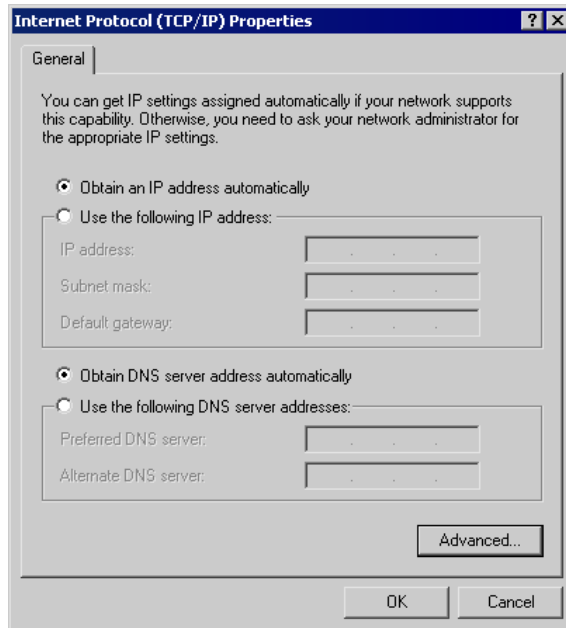

Figure 27: TCP/IP Properties (Win 2000)

5. Ensure your TCP/IP settings are correct, as described below.

Using DHCP

To use DHCP, select the radio button *Obtain an IP Address automatically*. This is the default Windows setting. **Using this is recommended.** By default, the 54Mbps 802.11g ADSL Firewall Modem Router will act as a DHCP Server.

Restart your PC to ensure it obtains an IP Address from the 54Mbps 802.11g ADSL Firewall Modem Router.

Using a fixed IP Address ("Use the following IP Address")

If your PC is already configured, check with your network administrator before making the following changes.

- Enter the 54Mbps 802.11g ADSL Firewall Modem Router's IP address in the *Default gateway* field and click *OK*. (Your LAN administrator can advise you of the IP Address they assigned to the 54Mbps 802.11g ADSL Firewall Modem Router.)
- If the *DNS Server* fields are empty, select *Use the following DNS server addresses*, and enter the DNS address or addresses provided by your ISP, then click *OK*.

Checking TCP/IP Settings - Windows XP

1. Select *Control Panel - Network Connection*.
2. Right click the *Local Area Connection* and choose *Properties*. You should see a screen like the following:

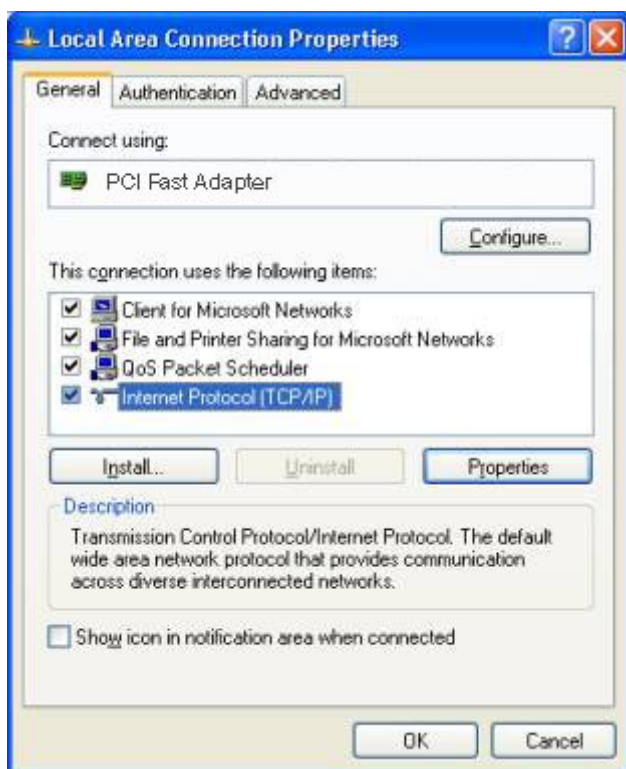

Figure 28: Network Configuration (Windows XP)

3. Select the *TCP/IP* protocol for your network card.
4. Click on the *Properties* button. You should then see a screen like the following.

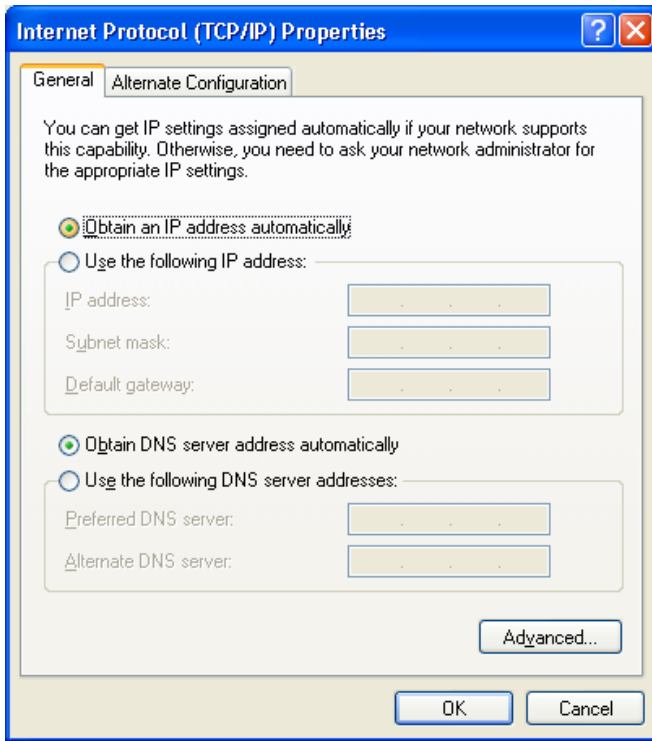

Figure 29: TCP/IP Properties (Windows XP)

5. Ensure your TCP/IP settings are correct.

Using DHCP

To use DHCP, select the radio button *Obtain an IP Address automatically*. This is the default Windows setting. **Using this is recommended.** By default, the 54Mbps 802.11g ADSL Firewall Modem Router will act as a DHCP Server.

Restart your PC to ensure it obtains an IP Address from the 54Mbps 802.11g ADSL Firewall Modem Router.

Using a fixed IP Address ("Use the following IP Address")

If your PC is already configured, check with your network administrator before making the following changes.

- In the *Default gateway* field, enter the 54Mbps 802.11g ADSL Firewall Modem Router's IP address and click *OK*. Your LAN administrator can advise you of the IP Address they assigned to the 54Mbps 802.11g ADSL Firewall Modem Router.
- If the *DNS Server* fields are empty, select *Use the following DNS server addresses*, and enter the DNS address or addresses provided by your ISP, then click *OK*.

Internet Access

To configure your PCs to use the 54Mbps 802.11g ADSL Firewall Modem Router for Internet access:

- Ensure that the DSL modem, Cable modem, or other permanent connection is functional.
- Use the following procedure to configure your Browser to access the Internet via the LAN, rather than by a Dial-up connection.

For Windows 9x/ME/2000

1. Select *Start Menu - Settings - Control Panel - Internet Options*.
2. Select the *Connection* tab, and click the *Setup* button.
3. Select "I want to set up my Internet connection manually, or I want to connect through a local area network (LAN)" and click *Next*.
4. Select "I connect through a local area network (LAN)" and click *Next*.
5. Ensure all of the boxes on the following Local area network Internet Configuration screen are **unchecked**.
6. Check the "No" option when prompted "Do you want to set up an Internet mail account now? "
7. Click *Finish* to close the Internet Connection Wizard.
Setup is now completed.

For Windows XP

1. Select *Start Menu - Control Panel - Network and Internet Connections*.
2. Select *Set up or change your Internet Connection*.
3. Select the *Connection* tab, and click the *Setup* button.
4. Cancel the pop-up "Location Information" screen.
5. Click *Next* on the "New Connection Wizard" screen.
6. Select "Connect to the Internet" and click *Next*.
7. Select "Set up my connection manually" and click *Next*.
8. Check "Connect using a broadband connection that is always on" and click *Next*.
9. Click *Finish* to close the New Connection Wizard.
Setup is now completed.

Accessing AOL

To access AOL (America On Line) through the 54Mbps 802.11g ADSL Firewall Modem Router, the *AOL for Windows* software must be configured to use TCP/IP network access, rather than a dial-up connection. The configuration process is as follows:

- Start the *AOL for Windows* communication software. Ensure that it is Version 2.5, 3.0 or later. This procedure will not work with earlier versions.
- Click the *Setup* button.
- Select *Create Location*, and change the location name from "New Locality" to "54Mbps 802.11g ADSL Firewall Modem Router".
- Click *Edit Location*. Select *TCP/IP* for the *Network* field. (Leave the *Phone Number* blank.)
- Click *Save*, then *OK*.
Configuration is now complete.
- Before clicking "Sign On", always ensure that you are using the "54Mbps 802.11g ADSL Firewall Modem Router" location.

Macintosh Clients

From your Macintosh, you can access the Internet via the 54Mbps 802.11g ADSL Firewall Modem Router. The procedure is as follows.

1. Open the TCP/IP Control Panel.
2. Select *Ethernet* from the *Connect via* pop-up menu.
3. Select *Using DHCP Server* from the *Configure* pop-up menu. The DHCP Client ID field can be left blank.
4. Close the TCP/IP panel, saving your settings.

Note:

If using manually assigned IP addresses instead of DHCP, the required changes are:

- Set the *Router Address* field to the 54Mbps 802.11g ADSL Firewall Modem Router's IP Address.
- Ensure your DNS settings are correct.

Linux Clients

To access the Internet via the 54Mbps 802.11g ADSL Firewall Modem Router, it is only necessary to set the 54Mbps 802.11g ADSL Firewall Modem Router as the "Gateway".

Ensure you are logged in as "root" before attempting any changes.

Fixed IP Address

By default, most Unix installations use a fixed IP Address. If you wish to continue using a fixed IP Address, make the following changes to your configuration.

- Set your "Default Gateway" to the IP Address of the 54Mbps 802.11g ADSL Firewall Modem Router.
- Ensure your DNS (Name server) settings are correct.

To act as a DHCP Client (recommended)

The procedure below may vary according to your version of Linux and X -windows shell.

1. Start your X Windows client.
2. Select *Control Panel - Network*
3. Select the "Interface" entry for your Network card. Normally, this will be called "eth0".
4. Click the *Edit* button, set the "protocol" to "DHCP", and save this data.
5. To apply your changes
 - Use the "Deactivate" and "Activate" buttons, if available.
 - OR, restart your system.

Other Unix Systems

To access the Internet via the 54Mbps 802.11g ADSL Firewall Modem Router:

- Ensure the "Gateway" field for your network card is set to the IP Address of the 54Mbps 802.11g ADSL Firewall Modem Router.
- Ensure your DNS (Name Server) settings are correct.

Wireless Station Configuration

This section applies to all Wireless stations wishing to use the 54Mbps 802.11g ADSL Firewall Modem Router's Access Point, regardless of the operating system which is used on the client.

To use the Wireless Access Point in the 54Mbps 802.11g ADSL Firewall Modem Router, each Wireless Station must have compatible settings, as follows:

Mode	The mode must be set to <i>Infrastructure</i> (rather than Ad-hoc) Access points only operate in to <i>Infrastructure</i> mode.
SSID (ESSID)	This must match the value used on the 54Mbps 802.11g ADSL Firewall Modem Router. The default value is default_ <u>Wireless</u> . Note! The SSID is case sensitive.
Wireless Security	By default, Wireless security on the 54Mbps 802.11g ADSL Firewall Modem Router is disabled. <ul style="list-style-type: none"> If Wireless security remains disabled on the 54Mbps 802.11g ADSL Firewall Modem Router, all stations must have wireless security disabled. If Wireless security is enabled on the Wireless Router (either WEP or WPA-PSK), each station must use the same settings as the Wireless ADSL Router.

Wireless Configuration on Windows XP

If using Windows XP to configure the Wireless interface on your PC, the configuration procedure is as follows:

1. Open the Network Connections folder. (*Start - Settings - Network Connections*).

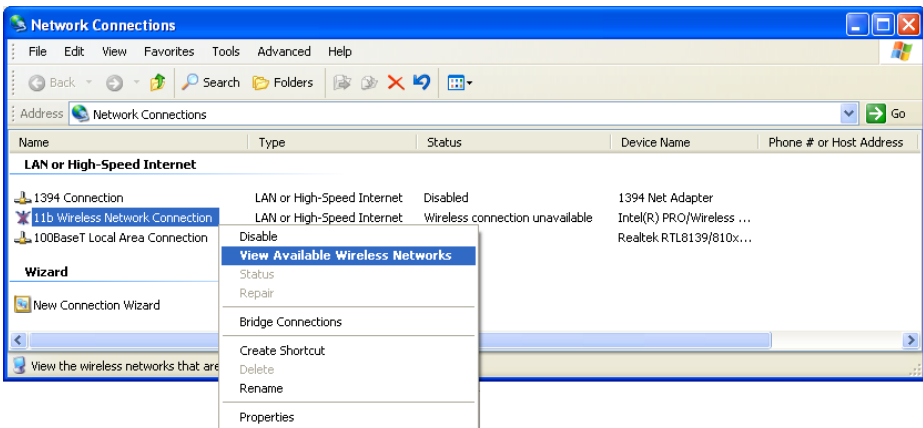

Figure 30: Network Connections (Windows XP)

2. Right-click the Wireless Network Connection, check that it is enabled (menu option says *Disable*, rather than *Enable*) and then select *View Available Wireless Networks*.
3. You will then see a list of wireless networks.

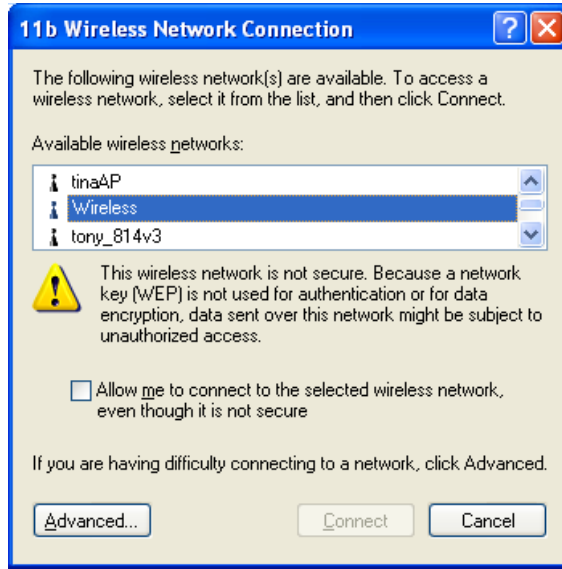

Figure 31 Wireless Networks (Windows XP)



Note!

If the "Broadcast SSID" setting on the 54Mbps 802.11g ADSL Firewall Modem Router has been disabled, its SSID will NOT be listed. See the following section "If the SSID is not listed" for details of dealing with this situation.

4. The next step depends on whether or not Wireless security has been enabled on the 54Mbps 802.11g ADSL Firewall Modem Router.

If Wireless Security is Disabled

If Wireless security on the 54Mbps 802.11g ADSL Firewall Modem Router is disabled, Windows will warn you that the Wireless network is not secure.

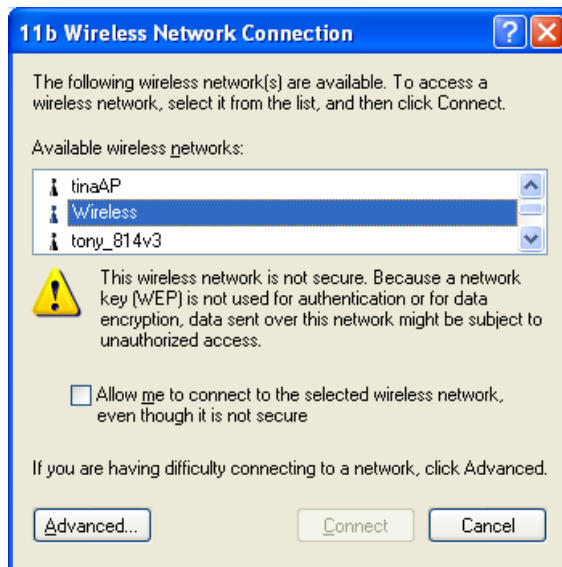

Figure 32: Insecure Wireless Network (Windows XP)

To connect:

- Check the checkbox *Allow me to connect to the selected wireless network, even though it is not secure*.
- The *Connect* button will then be available. Click the *Connect* button, and wait a few seconds for the connection to be established.

If using WEP Data Encryption

If WEP data encryption has been enabled on the 54Mbps 802.11g ADSL Firewall Modem Router, Windows will detect this, and show a screen like the following.

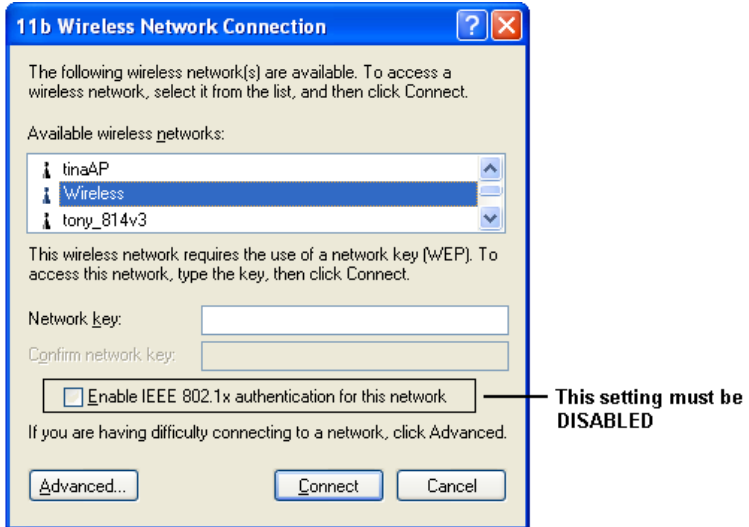

Figure 33: WEP (Windows XP)

To connect:

- Enter the WEP key, as set on the 54Mbps 802.11g ADSL Firewall Modem Router, in the *Network Key* field.
- Re-enter the WEP key into the *Confirm Network key* field.
- **Disable** the checkbox *Enable IEEE 802.1x authentication for this network*.
- Click the *Connect* button.

If this fails, click the *Advanced* button, to see a screen like the following:

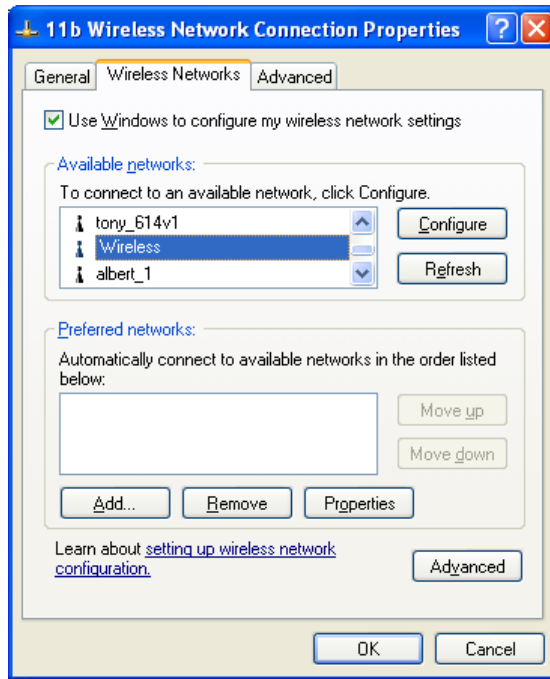

Figure 34: Advanced - Wireless Networks

Select the SSID for the 54Mbps 802.11g ADSL Firewall Modem Router, and click *Configure*, to see a screen like the following:

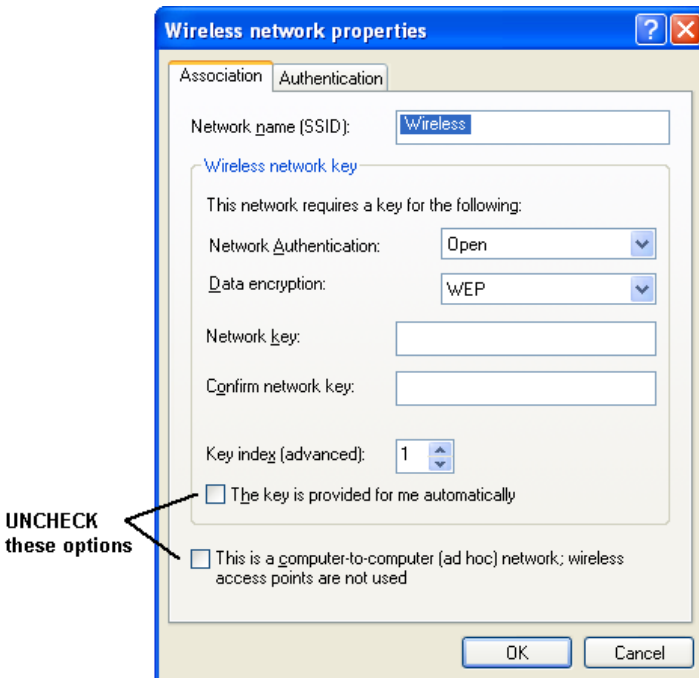

Figure 35: Wireless Network Properties - WEP

Configure this screen as follows:

- Set *Network Authentication* to match the 54Mbps 802.11g ADSL Firewall Modem Router. (If the setting on the 54Mbps 802.11g ADSL Firewall Modem Router is "Auto", then either *Open* or *Shared* can be used.)

- For *Data Encryption*, select **WEP**.
- For the *Network key* and *Confirm network key*, enter the **default key value** used on the 54Mbps 802.11g ADSL Firewall Modem Router. (Windows will determine if 64bit or 128bit encryption is used.)
- The *Key index* must match the **default key index** on the 54Mbps 802.11g ADSL Firewall Modem Router. The default value is 1.
- Ensure the options *The key is provided for me automatically* and *This is a computer-to-computer (ad hoc) network* are unchecked.
- Click OK to save and close this dialog.
- This wireless network will now be listed in *Preferred Networks* on the screen below.

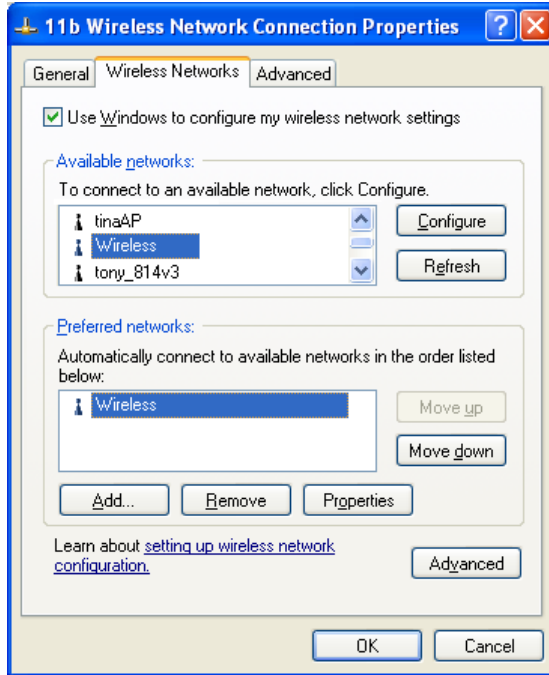

Figure 36: Preferred Networks

Click OK to establish a connection to the 54Mbps 802.11g ADSL Firewall Modem Router.

If using WPA-PSK Data Encryption

If WPA-PSK data encryption has been enabled on the 54Mbps 802.11g ADSL Firewall Modem Router, it does not matter which network is selected on the screen below. Just click the *Advanced* button.

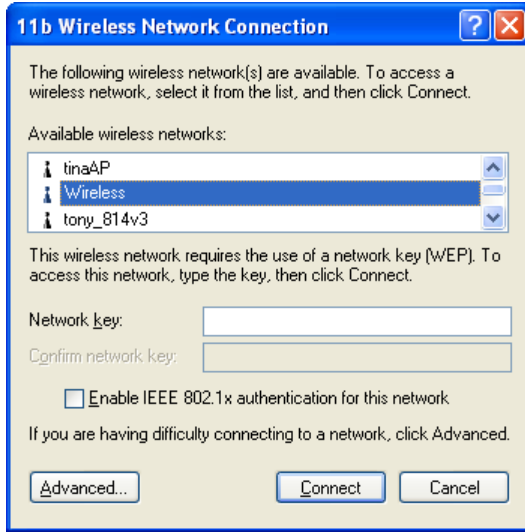

Figure 37: Wireless Networks (Windows XP)

You will then see a screen like the example below.

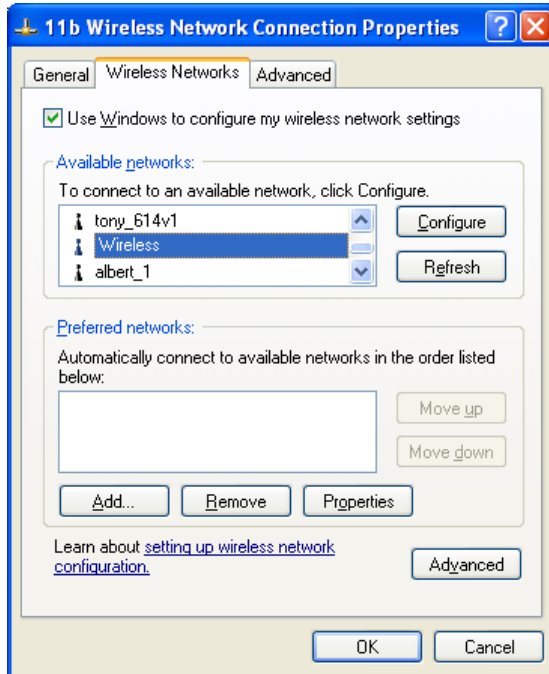

Figure 38: Advanced - Wireless Networks

Select the SSID for the 54Mbps 802.11g ADSL Firewall Modem Router, and click *Configure*, to see a screen like the following:

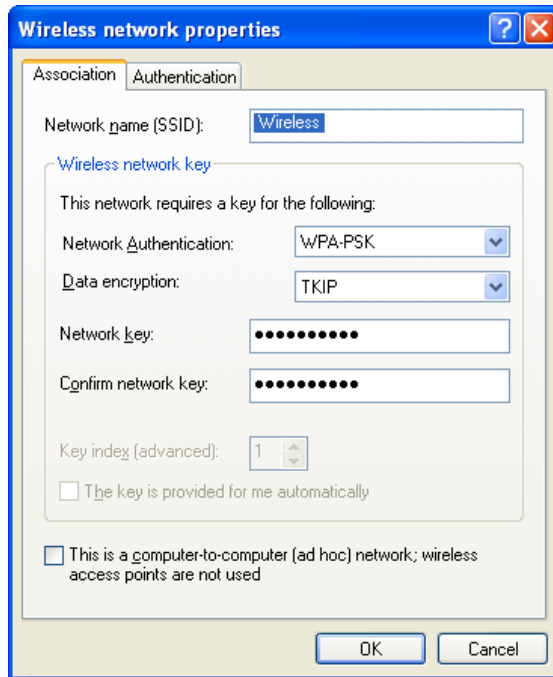

Figure 39: Wireless Network Properties- WPA-PSK

Configure this screen as follows:

- Set *Network Authentication* to **WPA-PSK**.
- For *Data Encryption*, select **TKIP**.
- For the *Network key* and *Confirm network key*, enter the network key (PSK) used on the 54Mbps 802.11g ADSL Firewall Modem Router.
- Ensure the option *This is a computer-to-computer (ad hoc) network* is unchecked.
- Click OK to save and close this dialog.
- This wireless network will now be listed in *Preferred Networks* on the screen below.

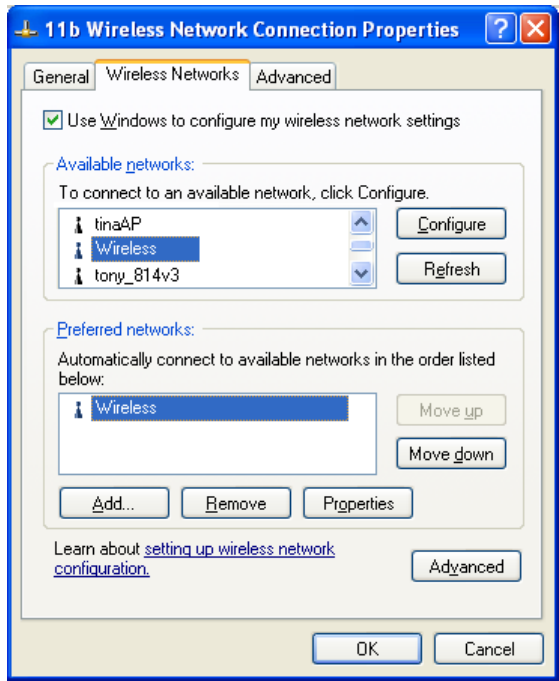

Figure 40: Preferred Networks

Click OK to establish a connection to the 54Mbps 802.11g ADSL Firewall Modem Router.

If the SSID is not listed

If the "Broadcast SSID" setting on the 54Mbps 802.11g ADSL Firewall Modem Router has been disabled, its SSID will NOT be listed on the screen below.

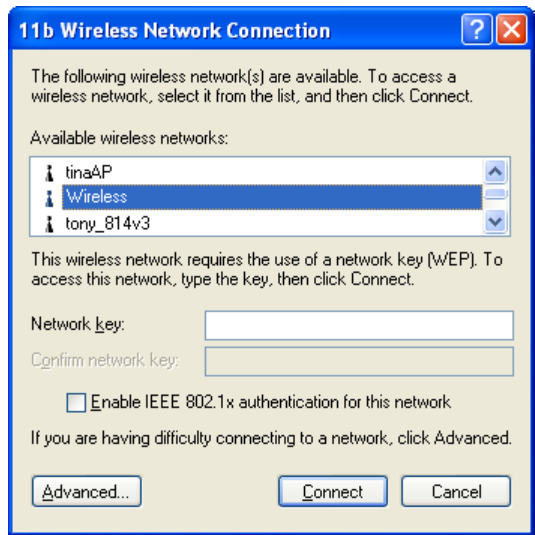

Figure 41: Wireless Networks (Windows XP)

In this situation, you need to obtain the SSID from your network administrator, then follow this procedure:

1. Click the *Advanced* button to see a screen like the example below.

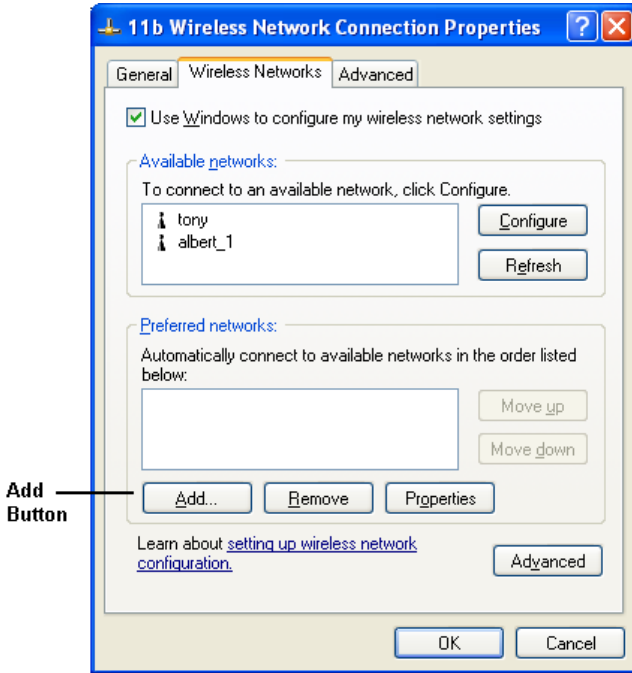

Figure 42: Unlisted Wireless Network

2. Click the *Add* button. You will see a screen like the example below.

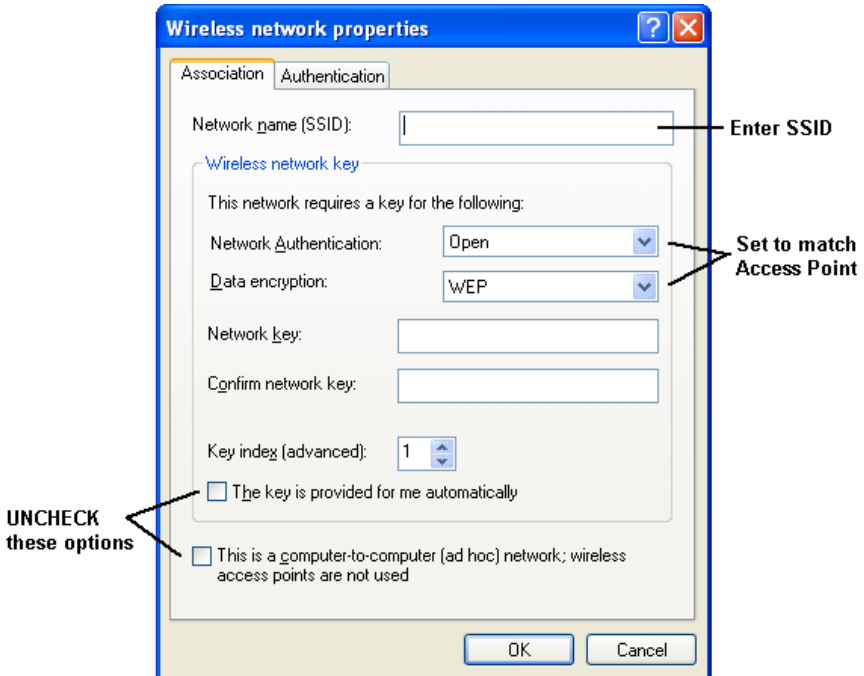

Figure 43: Add Wireless Network

3. Configure this screen as follows:
 - Enter the correct SSID, as used on the 54Mbps 802.11g ADSL Firewall Modem Router. Remember the SSID is case-sensitive, so be sure to match the case, not just the spelling.

- Set *Network Authentication* and *Data Encryption* to match the 54Mbps 802.11g ADSL Firewall Modem Router.
 - If using data encryption (WEP or WPA-PSK), enter the key used on the 54Mbps 802.11g ADSL Firewall Modem Router. See the preceding sections for details of WEP and WPA-PSK.
 - Uncheck the options *The key is provided for me automatically* and *This is a computer-to-computer (ad hoc) network*.
 - Click OK to save and exit.
4. This wireless network will then be listed in *Preferred Networks* on the screen below.

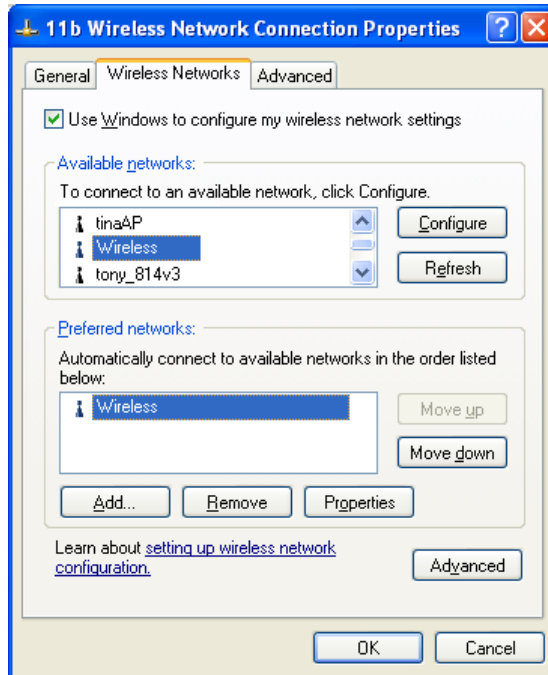

Figure 44: Preferred Networks

5. Click OK to establish a connection to the 54Mbps 802.11g ADSL Firewall Modem Router.

Chapter 5

Operation and Status



This Chapter details the operation of the 54Mbps 802.11g ADSL Firewall Modem Router and the status screens. For Details of operation in Bridge (Modem) mode, see Chapter 8 - Modem Mode.

Operation - Router Mode

Once both the 54Mbps 802.11g ADSL Firewall Modem Router and the PCs are configured, operation is automatic.

However, there are some situations where additional Internet configuration may be required. Refer to *Chapter 6 - Advanced Features* for further details.

Status Screen

Use the *Status* link on the main menu to view this screen.

Status

System	Device Name: TEW-435BRM (ANNEX A) Firmware Version: 1.00.06
Modem	Modem Status: Connecting DownStream Connection Speed: 0 kbps UpStream Connection Speed: 0 kbps VPI: 8 VCI: 35
Internet	Connection Method: IPOA Internet Connection: Idle Internet IP Address: --- Connection Details
LAN	IP Address: 192.168.0.1 Network Mask: 255.255.255.0 DHCP Server: On MAC Address: 00:C0:02:90:A0:10
Wireless	Name (SSID): default Region: -- Channel: 10 Wireless AP: enable Broadcast Name: enable

[Attached Devices](#) [Refresh Screen](#) [Help](#)

Status

Internet	Modem Status: Connecting DownStream Connection Speed: 0 kbps UpStream Connection Speed: 0 kbps Connection Method: PPPOE Internet Connection: Idle Internet IP Address: --- Connection Details
LAN	IP Address: 192.168.0.1 Network Mask: 255.255.255.0 DHCP Server: On MAC Address: 00:09:5b:70:46:6e
Wireless	Name (SSID): wireless Region: USA Channel: 11 Wireless AP: enable Broadcast Name: enable
System	Device Name: ADSL Router (ANNEX A) Firmware Version: 0.01.32

[Attached Devices](#) [Refresh Screen](#) [Help](#)

The screenshot shows a 'Status' screen with a green header. It is divided into four sections: Internet, LAN, Wireless, and System. The Internet section shows 'Modem Status' as 'Connecting', 'DownStream Connection Speed' as '0 kbps', 'UpStream Connection Speed' as '0 kbps', 'Connection Method' as 'PPPOE', 'Internet Connection' as 'Not connected', and 'Internet IP Address' as '---'. A 'Connection Details' button is present. The LAN section shows 'IP Address: 192.168.0.1', 'Network Mask: 255.255.255.0', 'DHCP Server: On', and 'MAC Address: 00:e0:a0:f4:f5:88'. The Wireless section shows 'Name (SSID): haha', 'Region: Europe', 'Channel: 11', 'Wireless AP: enable', and 'Broadcast Name: enable'. The System section shows 'Device Name: IP806GA' and 'Firmware Version: 0.01.12'. At the bottom are 'Refresh Screen' and 'Help' buttons.

Status		
Internet	Modem Status	Connecting
	DownStream Connection Speed	0 kbps
	UpStream Connection Speed	0 kbps
	Connection Method:	PPPOE
	Internet Connection:	Not connected
	Internet IP Address:	---
Connection Details		
LAN	IP Address:	192.168.0.1
	Network Mask:	255.255.255.0
	DHCP Server:	On
	MAC Address	00:e0:a0:f4:f5:88
Wireless	Name (SSID)	haha
	Region	Europe
	Channel	11
	Wireless AP	enable
	Broadcast Name	enable
System	Device Name:	IP806GA
	Firmware Version:	0.01.12
Refresh Screen Help		

Figure 45: Status Screen

Data - Status Screen

System	
Device Name	The current name of the Router. This name is also the "hostname" for users with an "@Home" type connection.
Firmware Version	The version of the current firmware installed.
ModemInternet	
Modem Status	This indicates the status of the ADSL modem component.
DownStream Connection Speed	Displays the speed for the DownStream Connection.
UpStream Connection Speed	If connected, displays the speed for the Up_Stream (upload) ADSL Connection.
VPI	This displays the current VPI setting used for the ADSL connection.
VCI	This displays the current VCI setting used for the ADSL connection.
Internet	
Connection Method	Displays the current connection method, as set in the <i>Setup Wizard</i> .

Internet Connection	<p>This indicates the current status of the Internet Connection</p> <ul style="list-style-type: none"> • Connected Active - Connection exists • Not connected Idle - <u>No current connection, but no error has been detected. This condition normally arises when an idle connection is automatically terminated. No connection established.</u> • Negotiation Failed - <u>The connection was terminated abnormally. This could be caused by Modem failure, or the loss of the connection to the ISP's server. The connection is under establishing.</u> <p><u>If there is an error, you can click the "Connection Details" button to find out more information. You can click the "Connection Details" button to find out more information.</u></p>
Internet IP Address	<p>This IP Address is allocated by the ISP (Internet Service Provider). If using a dynamic IP address, and no connection currently exists, this information is unavailable.</p>
<u>Connection Details</u>	<p><u>Click this button to open a sub-window and view a detailed description of the current connection. Depending on the type of connection, a "log" may also be available.</u></p>
LAN	
IP Address	<p>The IP Address of the 54Mbps 802.11g ADSL Firewall Modem Router.</p>
Network Mask	<p>The Network Mask (Subnet Mask) for the IP Address above.</p>
DHCP Server	<p>This shows the status of the DHCP Server function. The value will be "Enabled" or "Disabled".</p>
MAC Address	<p>This shows the MAC Address for the 54Mbps 802.11g ADSL Firewall Modem Router, as seen on the LAN interface.</p>
Wireless	
Name (SSID)	<p>If using an ESS (Extended Service Set, with multiple access points) this ID is called an ESSID (Extended Service Set Identifier).</p>
Region	<p>The current region, as set on the Wireless screen.</p>
Channel	<p>This shows the Channel currently used, as set on the Wireless screen.</p>
Wireless AP	<p>This indicates whether or not the Wireless Access Point feature is enabled.</p>
Broadcast Name	<p>This indicates whether or not the SSID is Broadcast. This setting is on the Wireless screen.</p>
System	
Device Name	<p>The current name of the Wireless ADSL Router. This is also the "hostname" provided to ISPs who request this information.</p>
Firmware Version	<p>The version of the current firmware installed.</p>

Buttons	
Connection Details	Click this button to open a sub-window and view a detailed description of the current connection.
Attached Devices	This will open a sub-window, showing all LAN and Wireless devices currently on the network.
Refresh Screen	Update the data displayed on screen.

Connection Status - PPPoE & PPPoA

If using PPPoE (PPP over Ethernet) or PPPoA (PPP over ATM), a screen like the following example will be displayed when the "Connection Details" button is clicked.

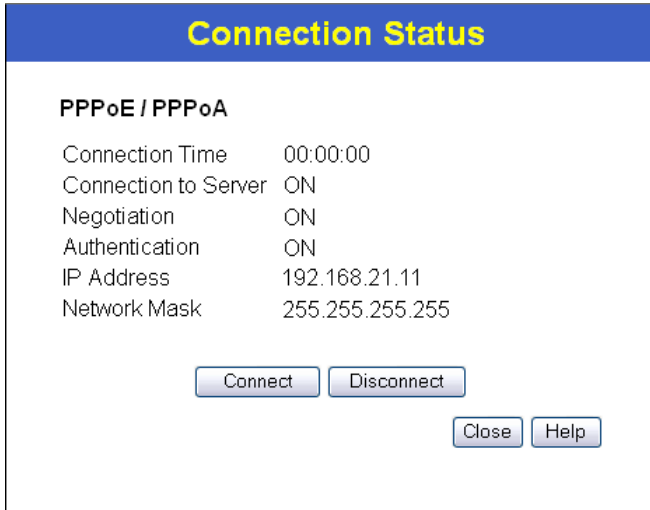

Figure 46: PPPoE Status Screen

Data - PPPoE/PPPoA Screen

Connection Time	This indicates how long the current connection has been established.
Connection to Server	This indicates whether or not the connection is currently established. <ul style="list-style-type: none"> • If the connection does not exist, the "Connect" button can be used to establish a connection. • If the connection currently exists, the "Disconnect" button can be used to break the connection.
Negotiation	This will show the Negotiation status of the connection.
Authentication	This will show the Authentication status of the connection.
IP Address	The IP Address of this device, as seen by Internet users. This address is allocated by your ISP (Internet Service Provider).
Network Mask	The Network Mask associated with the IP Address above.
Buttons	
Connect	If not connected, establish a connection to your ISP.
Disconnect	If connected to your ISP, hang up the connection.
Close	Close this window.

Connection Details - Dynamic IP Address

If your access method is "Direct" (no login), with a Dynamic IP address, a screen like the following example will be displayed when the "Connection Details" button is clicked.



Figure 47: Connection Details - Dynamic IP Address

Data - Dynamic IP address

Internet	
IP Address	The current IP Address of this device, as seen by Internet users. This address is allocated by your ISP (Internet Service Provider).
Subnet Mask	The Network Mask associated with the IP Address above.
Default Gateway	The IP address of the remote Gateway or Router associated with the IP Address above.
DNS Server	The IP address of the Domain Name Server which is currently used.
DHCP Server	The IP address of your ISP's DHCP Server.
Lease Obtained Lease Expires	This indicates when the current IP address was obtained, and how long before this IP address allocation (the DHCP lease) expires.
Buttons	
Release	If an IP Address has been allocated to the 54Mbps 802.11g ADSL Firewall Modem Router (by the ISP's DHCP Server, clicking the "Release" button will break the connection and release the IP Address.
Renew	If the ISP's DHCP Server has NOT allocated an IP Address for the 54Mbps 802.11g ADSL Firewall Modem Router, clicking the "Renew" button will attempt to re-establish the connection and obtain an IP Address from the ISP's DHCP Server.
Close	Close this window.

Connection Details - Fixed IP Address

If your access method is "Direct" (no login), with a fixed IP address, a screen like the following example will be displayed when the "Connection Details" button is clicked.

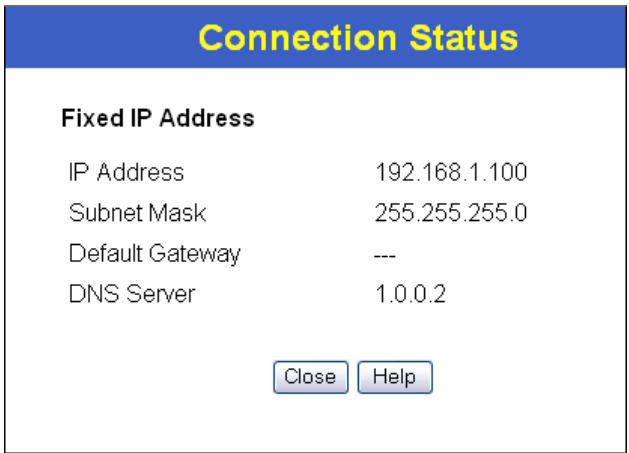

Figure 48: Connection Details - Fixed IP Address

Data - Fixed IP address Screen

Internet	
IP Address	The IP Address of this device, as seen by Internet users. This address is allocated by your ISP (Internet Service Provider).
Subnet Mask	The Network Mask associated with the IP Address above.
Default Gateway	The IP Address of the remote Gateway or Router associated with the IP Address above.
DNS Server	The IP Address of the Domain Name Server which is currently used.

Connection Details - BPA (Telstra Big Pond)

An example screen is shown below.

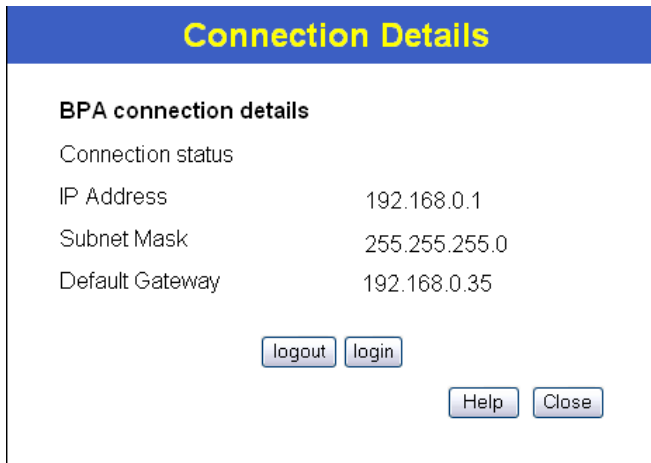

Figure 49: Connection Details - BPA

Data - BPA Screen

BPA Connection details	
Connection status	This connection status will show the BPA connection connected or not
IP Address	The IP Address of this device, as seen by Internet users. This address is allocated by your ISP (Internet Service Provider).
Subnet Mask	The Subnet Mask associated with the IP Address above.
Default Gateway	The IP Address of the remote Gateway or Router associated with the IP Address above.

Chapter 6

Advanced Features

6

This Chapter explains when and how to use the 54Mbps 802.11g ADSL Firewall Modem Router's "Advanced" Features.

Overview

The following advanced features are provided:

- ~~Advanced~~ Internet:
 - DMZ
 - Special Applications
 - URL filter
- Dynamic DNS
- Firewall ~~Rules~~ Rules
- Firewall Services
- Options
- Schedule ~~ing~~
- Virtual Servers

Advanced Internet

This screen provides access to the DMZ, Special Applications and URL Filter features.

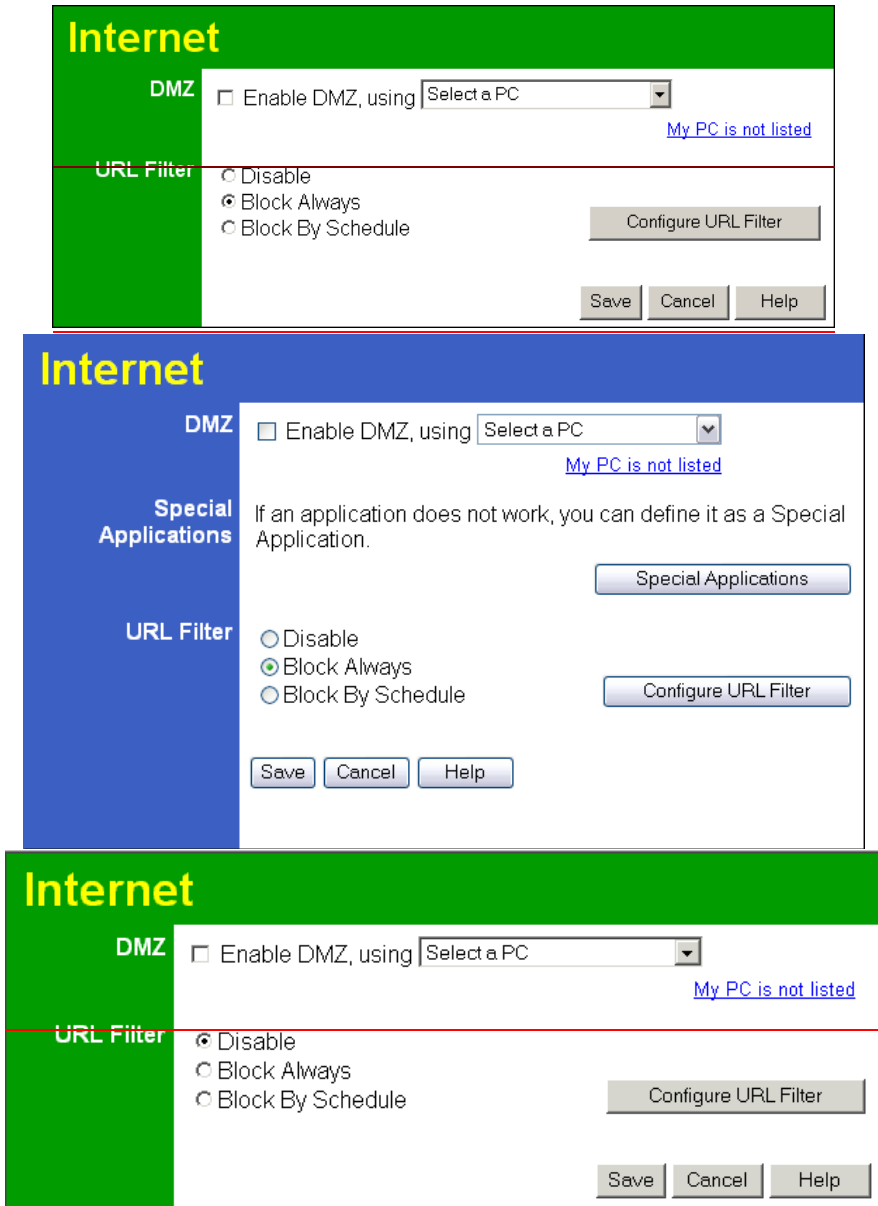

Figure 50: ~~Advanced~~ Internet Screen

DMZ

This feature, if enabled, allows the DMZ computer on your LAN to be exposed to all users on the Internet.

- This allows almost any application to be used on the "DMZ PC".
- The "DMZ PC" will receive all "Unknown" connections and data.
- If the DMZ feature is enabled, you must select the PC to be used as the "DMZ PC".



The "DMZ PC" is effectively outside the Firewall, making it more vulnerable to attacks. For this reason, you should only enable the DMZ feature when required.

Special Applications

If you use Internet applications which use non-standard connections or port numbers, you may find that they do not function correctly because they are blocked by the Wireless Router's firewall. In this case, you can define the application as a "Special Application".

The *Special Applications* screen can be reached by clicking the *Special Applications* button on the *Internet* screen.

You can then define your Special Applications. You will need detailed information about the application; this is normally available from the supplier of the application.

Also, note that the terms "Incoming" and "Outgoing" on this screen refer to traffic from the client (PC) viewpoint

Enable	Name	Outgoing Ports			Incoming Ports		
		Type	Start	Finish	Type	Start	Finish
1. <input type="checkbox"/>		TCP			TCP		
2. <input type="checkbox"/>		TCP			TCP		
3. <input type="checkbox"/>		TCP			TCP		
4. <input type="checkbox"/>		TCP			TCP		
5. <input type="checkbox"/>		TCP			TCP		
6. <input type="checkbox"/>		TCP			TCP		
7. <input type="checkbox"/>		TCP			TCP		
8. <input type="checkbox"/>		TCP			TCP		
9. <input type="checkbox"/>		TCP			TCP		
10. <input type="checkbox"/>		TCP			TCP		
11. <input type="checkbox"/>		TCP			TCP		
12. <input type="checkbox"/>		TCP			TCP		

Figure 51: Special Applications Screen

Data - Special Applications Screen

Enable	Use this to Enable or Disable this Special Application as required.
Name	Enter a descriptive name to identify this Special Application.

<p><u>Incoming Ports</u></p>	<ul style="list-style-type: none"> • Type - Select the protocol (TCP or UDP) used when you receive data from the special application or service. (Note: Some applications use different protocols for outgoing and incoming data). • Start - Enter the beginning of the range of port numbers used by the application server, for data you receive. If the application uses a single port number, enter it in both the "Start" and "Finish" fields. • Finish - Enter the end of the range of port numbers used by the application server, for data you receive.
<p><u>Outgoing Ports</u></p>	<ul style="list-style-type: none"> • Type - Select the protocol (TCP or UDP) used when you send data to the remote system or service. • Start - Enter the beginning of the range of port numbers used by the application server, for data you send to it. If the application uses a single port number, enter it in both the "Start" and "Finish" fields. • Finish - Enter the end of the range of port numbers used by the application server, for data you send to it. If the application uses a single port number, enter it in both the "Start" and "Finish" fields.

Using a Special Application

- Configure the *Special Applications* screen as required.
- On your PC, use the application normally. Remember that only one (1) PC can use each Special application at any time. Also, when 1 PC is finished using a particular Special Application, there may need to be a "Time-out" before another PC can use the same Special Application. The "Time-out" period may be up to 3 minutes.

URL Filter

If you want to limit access to certain sites on the Internet, you can use this feature. The URL filter will check each Web site access. If the address, or part of the address, is included in the block site list, access will be denied.

On the *Advanced Internet* screen, select the desired setting:

- **Disable Never** - disable this feature.
- **Block Always** - allow blocking all of the time, independent of the *Schedule* page.
- **Block By Schedule** - block according to the settings on the *Schedule* page.

Click the **Configure URL Filter** button to open the URL Filter screen, allowing you to create or modify the filter strings which determine which sites will be blocked.

URL Filter Screen

The ***URL Filter*** screen is displayed when the **Configure URL Filter** button on the *Advanced Internet* screen is clicked.

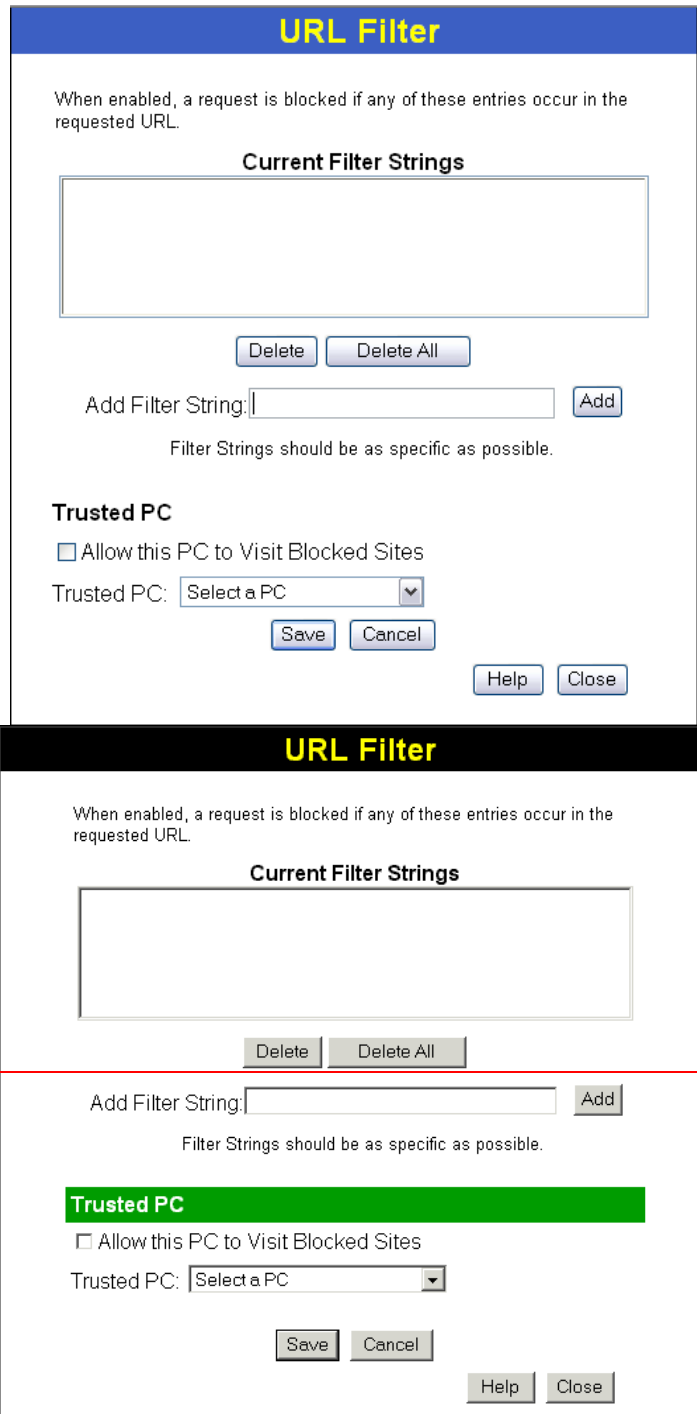

Figure 52: URL Filter Screen

Data - URL Filter Screen

Current Filter Strings	
Current Filter Strings	<p>The list contains the current list of items to block.</p> <ul style="list-style-type: none">• To add to the list, use the "Add" option below.• To delete an entry, select it and click Delete button.• To delete all entries, click the Delete All button.
Add Filter String	<p>To add to the current list, type the word or domain name you want to block into the field provided, then click the Add button.</p> <p>Filter strings should be as specific as possible. Otherwise, you may block access to many more sites than intended.</p>
Trusted PC	
Allow Trusted PC	<p>Enable this to allow one computer to have unrestricted access to the Internet. For this PC, the URL filter will be ignored.</p> <p>If enabled, you must select the PC to be the trusted PC.</p>
Trusted PC	<p>Select the PC to be the Trusted PC.</p>

Dynamic DNS (Domain Name Server)

This free service is very useful when combined with the *Virtual Server* feature. It allows Internet users to connect to your Virtual Servers using a URL, rather than an IP Address.

This also solves the problem of having a dynamic IP address. With a dynamic IP address, your IP address may change whenever you connect, which makes it difficult to connect to you.

DDNS Services work as follows:

1. You must register for the service at one of the listed DDNS Service providers.
2. After registration, use the Service provider's normal procedure to obtain your desired Domain name.
3. Enter your DDNS data on the 54Mbps 802.11g ADSL Firewall Modem Router's DDNS screen, and enable the DDNS feature.
4. The 54Mbps 802.11g ADSL Firewall Modem Router will then automatically ensure that your current IP Address is recorded at the DDNS service provider's Domain Name Server.
5. From the Internet, users will be able to connect to your Virtual Servers (or DMZ PC) using your Domain name, as shown on this screen.

Dynamic DNS Screen

Select *Advanced* on the main menu, then *Dynamic DNS*, to see a screen like the following:

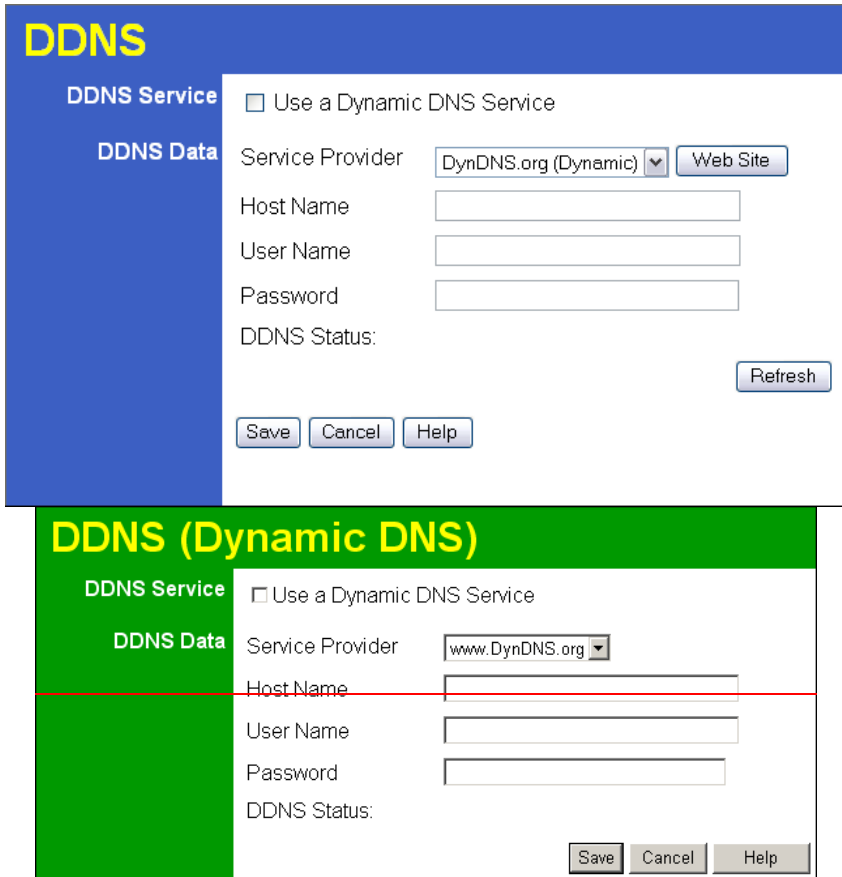

Figure 53: DDNS Screen

Data - Dynamic DNS Screen

DDNS Service	
Use a Dynamic DNS Service	Use this to enable or disable the DDNS feature as required.
Service Provider	Select the desired DDNS Service provider.
Web Site	Click this button to open a new window and connect to the Web site of the selected DDNS service provider.
DDNS Data	
Host Name	Enter the domain name allocated to you by the DDNS Service. If you have more than one name, enter the name you wish to use.
User Name	Enter your Username for the DDNS Service. (TZO.com uses your E-mail address.)
Password	Enter your current password for the DDNS Service. (TZO.com calls this a key.)
Domain Name	Enter the domain name allocated to you by the DDNS Service. If you have more than one name, enter the name you wish to use.
DDNS Status	<ul style="list-style-type: none">• This message is returned by the DDNS Server.• Normally, this message should be "Update successful"• If the message indicates some problem, you need to connect to the DDNS Service provider and correct this problem.

Firewall Rules

The **Firewall Rules** screen allows you to define "Firewall Rules" which can allow or prevent certain traffic. "Traffic" means incoming connection attempts, not packets.

By default:

- All Outgoing traffic is permitted.
- All Incoming traffic is denied.

Because of this default behavior, any **Outgoing** rules will generally **Block** traffic, and **Incoming** rules will generally **Allow** traffic.

Firewall Rules Screen

An example screen is shown below.

The screenshot shows two instances of the Firewall Rules screen. The top instance has a blue header, and the bottom instance has a green header. Both screens display the same content:

Incoming Rules

#	Enable	Service Name	Action	LAN Server IP address	WAN Users	Log
Default	Yes	Any	BLOCK always	--	Any	Match

Buttons: Add, Edit, Move, Delete

Outgoing Rules

#	Enable	Service Name	Action	LAN Users	WAN Servers	Log
Default	Yes	Any	ALLOW always	Any	Any	Never

Buttons: Add, Edit, Move, Delete

Buttons: Save, Cancel, Help

Figure 54 Firewall Screen

Data - Firewall Rules

Incoming Rules	
#	For the default rule, this will display "Default". For rules which you create, this will display a radio button which allows you to select the rule.
Enable	Indicates whether or not the rule is currently enabled. For rules you have added, this column will contain a checkbox, allowing you to easily enable or disable the rule. (Click "Save" after making any changes.)
Service Name	The Service covered by this rule.
Action	The action performed on connections which are covered by this rule.
LAN Server IP Address	The PC or Server on your LAN to which traffic covered by this rule will be sent.
WAN Users	The WAN IP address or addresses covered by this rule.
Log	Indicates whether or not connections covered by this rule should be logged.
Buttons	Use the <i>Add</i> button to create a new rule. The other buttons - <i>Edit</i> , <i>Move</i> , or <i>Delete</i> - require that a rule be selected first. Use the radio buttons in the left column to select the desired rule.
Outgoing Rules	
#	For the default rule, this will display "Default". For rules which you create, this will display a radio button which allows you to select the rule.
Enable	Indicates whether or not the rule is currently enabled. For rules you have added, this column will contain a checkbox, allowing you to easily enable or disable the rule. (Click "Save" after making any changes.)
Service Name	The Service covered by this rule.
Action	The action performed on connections which are covered by this rule.
LAN Users	The LAN PC or PCs covered by this rule.
WAN Servers	The WAN IP address or addresses covered by this rule.
Log	Indicates whether or not connections covered by this rule should be logged.
Buttons	Use the <i>Add</i> button to create a new rule. The other buttons - <i>Edit</i> , <i>Move</i> , or <i>Delete</i> - require that a rule be selected first. Use the radio buttons in the left column to select the desired rule.

Incoming Rules (Inbound Services)

This screen is displayed when the "Add" or "Edit" button for Incoming Rules is clicked.

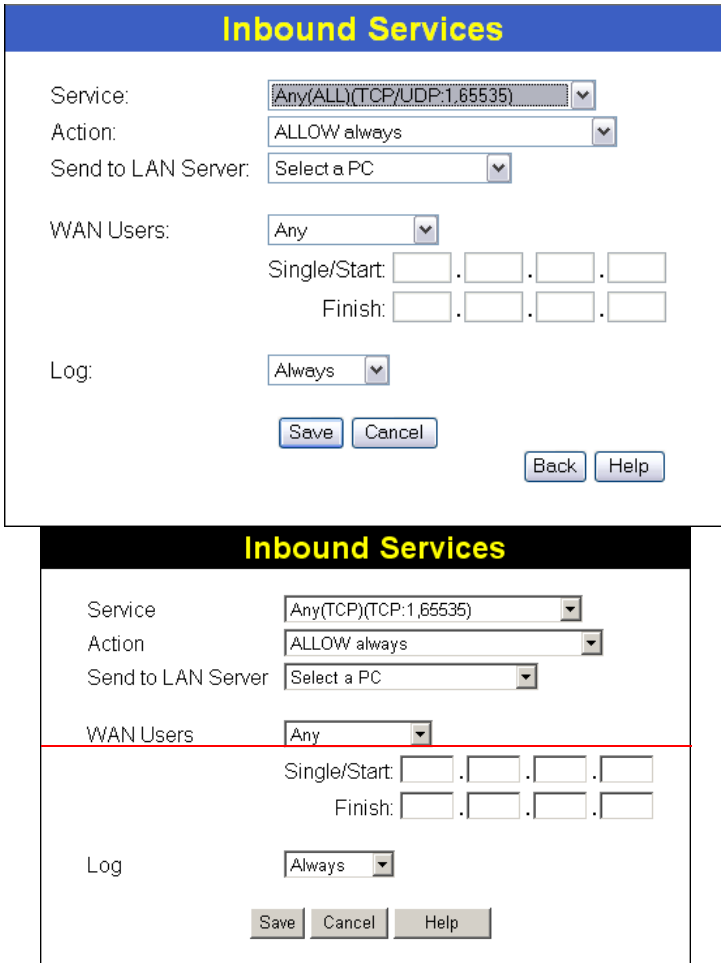

Figure 55: Inbound Services Screen

Data - Incoming Rules Screen

Inbound Services	
Service	Select the desired Service. This determines which packets are covered by this rule. If necessary, you can define a new Service on the "Services" screen, by defining the protocols and port numbers used by the Service.
Action	<p>Select the desired action for packets covered by this rule:</p> <ul style="list-style-type: none"> • ALLOW always • ALLOW by schedule, otherwise Block • BLOCK always • BLOCK by schedule, otherwise Allow <p>Note:</p> <ul style="list-style-type: none"> • Any inbound traffic which is not allowed by rules you create will be blocked by the Default rule. • BLOCK rules are only useful if the traffic is already covered by an

	<p>ALLOW rule. (That is, you wish to block a sub-set of traffic which is currently allowed by another rule.)</p> <ul style="list-style-type: none"> • To define the Schedule used in these selections, use the "Schedule" screen.
Send to LAN Server	Select the PC or Server on your LAN which will receive the inbound traffic covered by this rule.
WAN Users	<p>These settings determine which packets are covered by the rule, based on their source (WAN) IP address. Select the desired option:</p> <ul style="list-style-type: none"> • Any - All IP addresses are covered by this rule. • Single address - Enter the required address in the "Single/Start" fields. • Address range - If this option is selected, you must enter the desired values in the "Single/Start" and "Finish" fields to determine the address range.
Log	<p>This determines whether packets covered by this rule are logged. Select the desired action.</p> <ul style="list-style-type: none"> • Always - always log traffic considered by this rule, whether it matches or not. (This is useful when debugging your rules.) • Never - never log traffic considered by this rule, whether it matches or not. • Match - Log traffic only it matches this rule. (The action is determined by this rule.) • Not Match - Log traffic which is considered by this rule, but does not match (The action is NOT determined by this rule.)

Outgoing Rules (Outbound Services)

This screen is displayed when the "Add" or "Edit" button for Outgoing Rules is clicked.

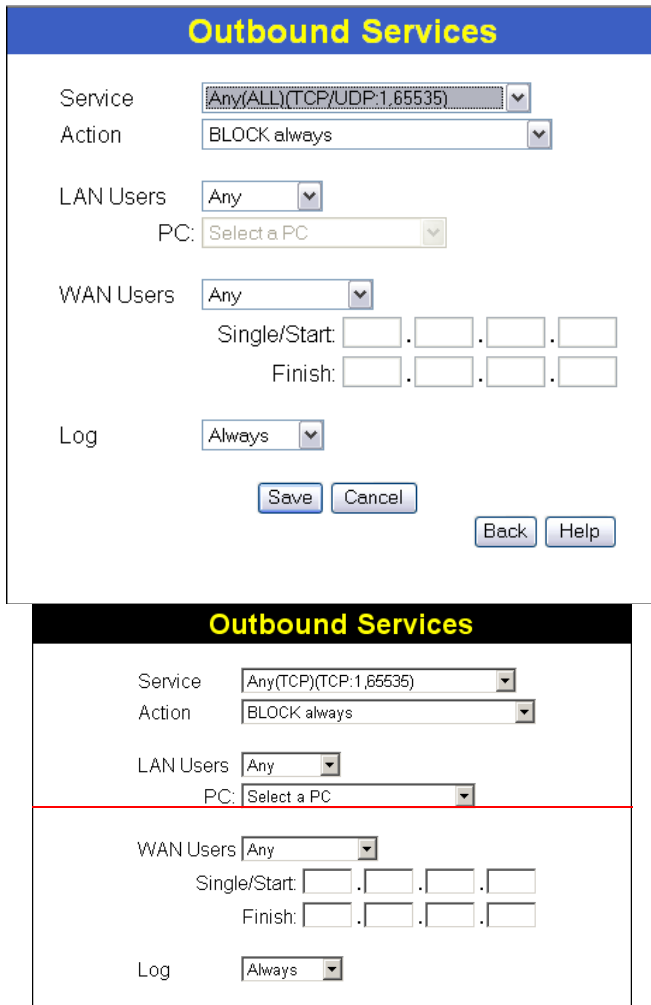

Figure 56: Outbound Services Screen

Data - Outbound Rules Screen

Outbound Services	
Service	Select the desired Service or application to be covered by this rule. If the desired service or application does not appear in the list, you must define it using the "Services" menu option
Action	<p>Select the desired action for packets covered by this rule:</p> <ul style="list-style-type: none"> • BLOCK always • BLOCK by schedule, otherwise Allow • ALLOW always • ALLOW by schedule, otherwise Block <p>Note:</p> <ul style="list-style-type: none"> • Any outbound traffic which is not blocked by rules you create will be allowed by the Default rule. • ALLOW rules are only useful if the traffic is already covered by a BLOCK rule. (That is, you wish to allow a subset of traffic which is currently blocked by another rule.)

	<ul style="list-style-type: none"> To define the Schedule used in these selections, use the "Schedule" screen.
LAN Users	<p>Select the desired option to determine which PCs are covered by this rule:</p> <ul style="list-style-type: none"> Any - All PCs are covered by this rule. Single PC - Only the selected PC is covered by this rule. If selected, you must select the PC. <p>PC - If using Single PC above, select the PC or Server on your LAN which will be covered by this rule.</p>
WAN Users	<p>These settings determine which packets are covered by the rule, based on their source (WAN) IP address. Select the desired option:</p> <ul style="list-style-type: none"> Any - All IP addresses are covered by this rule. Single address - Enter the required address in the "Single/Start" fields. Address range - If this option is selected, you must enter the "Start" and "Finish" fields.
Log	<p>This determines whether packets covered by this rule are logged. Select the desired action.</p> <ul style="list-style-type: none"> Always - always log traffic considered by this rule, whether it matches or not. (This is useful when debugging your rules.) Never - never log traffic considered by this rule, whether it matches or not. Match - Log traffic only it matches this rule. (The action is determined by this rule.) Not Match - Log traffic which is considered by this rule, but does not match (The action is NOT determined by this rule.)

Services

Services are used when creating Firewall Rules.

If you wish to create a firewall rule, but the required service is not listed in the "Service" list, you can use this feature to define the required service or services. Once created, these services will be listed in the "Service" list, and can be used when creating Firewall Rules.

~~This screen is used to modify the list of Services which are available when creating Firewall Rules.~~

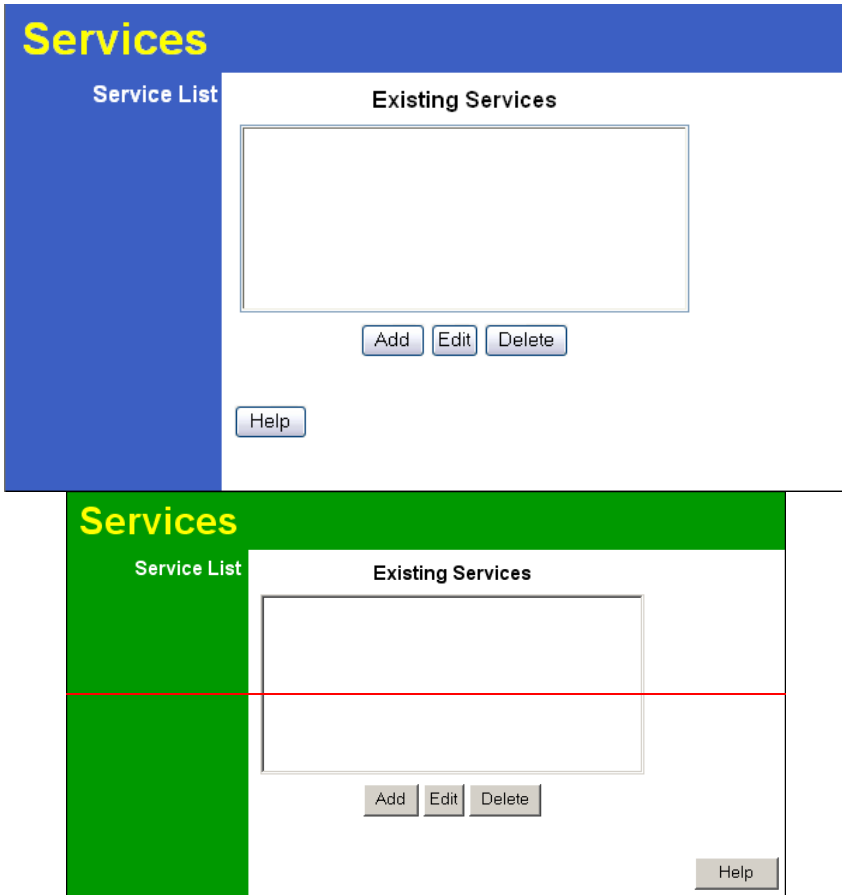

Figure 57: ~~Firewall~~ Services Screen

Data - Services

Services	
Existing Services	This lists <u>any Services you have</u> l defined. <u>If you have not defined any Services, this list will be empty.</u> Services. <u>Once you define some services, they will be listed here, and also shown in the Service list used to create Firewall rules. (User-defined services are at the end of the list, after the pre-defined services.)</u>
Add	Use this to open a sub-screen where you can add a new service.
Edit	To modify a service, select it, and then click this button.
Delete	Pre-defined Services can not be deleted, but you can a <u>U</u> se this button

	to delete <u>the selected service</u> . <u>You can delete</u> any services you have defined.
--	--

Add/Edit Service

This screen is displayed when the *Add* or *Edit* button on the *Services* screen is clicked.

The figure displays two versions of the 'Add/Edit Service' form. The top version has a blue header with the title 'Add/Edit Service' in yellow. It contains four input fields: 'Name' (text), 'Type' (dropdown menu with 'TCP' selected), 'Start Port' (text), and 'Finish Port' (text). Below these fields are two buttons: 'Save' and 'Cancel'. At the bottom right are two more buttons: 'Back' and 'Help'. The bottom version has a black header with the title 'Add/Edit Service' in yellow. It contains the same four input fields. Below them are 'Save' and 'Cancel' buttons. At the bottom are 'Help' and 'Close' buttons. A red horizontal line is drawn across the form between the 'Start Port' and 'Finish Port' fields in the bottom version.

Figure 58: Add/Edit Service

Data - Add/Edit Service

Services	
Name	If editing, this shows the current name of the Service. If adding a new service, this will be blank, and you should enter a suitable name.
Type	Select the protocol used by the Service.
Start Port	Enter the beginning of the port range used by the Service.
Finish Port	Enter the end of the port range used by the Service.

Options

This screen allows advanced users to enter or change a number of settings. For normal operation, there is no need to use this screen or change any settings.

An example *Options* screen is shown below.

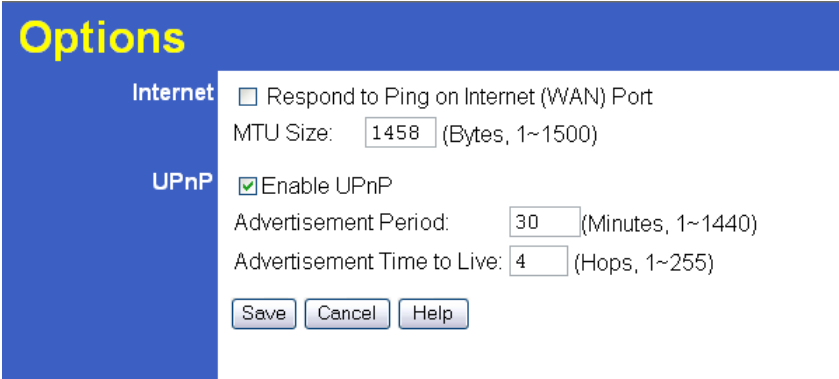

Figure 59: Options Screen

Data - Options Screen

<u>Internet</u>	
<u>Respond to Ping</u>	<ul style="list-style-type: none"> <u>If checked, the Wireless Router will respond to Ping (ICMP) packets received from the Internet.</u> <u>If not checked, Ping (ICMP) packets from the Internet will be ignored. Disabling this option provides a slight increase in security.</u>
<u>MTU Size</u>	<p><u>Enter a value between 1 and 1500.</u></p> <p>Note: <u>MTU (Maximum Transmission Unit) size should only be changed if advised to do so by Technical Support.</u></p>
<u>UPnP</u>	
<u>UPnP</u>	<ul style="list-style-type: none"> <u>UPnP (Universal Plug and Play) allows automatic discovery and configuration of equipment attached to your LAN. UPnP is by supported Windows ME, XP, or later.</u> <u>If Enabled, this device will be visible via UPnP.</u> <u>If Disabled, this device will not be visible via UPnP.</u>
<u>Advertisement Period</u>	<u>Enter the desired value, in minutes. The valid range is from 1 to 1440.</u>
<u>Advertisement Time to Live</u>	<u>Enter the desired value, in hops. The valid range is from 1 to 255.</u>

Schedule

This Schedule can be used for the Firewall Rules and the URL filter.

Schedule

Schedule

Every Day
 Sunday
 Monday
 Tuesday
 Wednesday
 Thursday
 Friday
 Saturday

Time of day: (use 24-hour clock)

Local Time

All Day

Start Time Hour Minute
 End Time Hour Minute

Time Zone: (GMT) Greenwich Mean Time : Edinburgh, London

Adjust for Daylight Savings Time
 Use this NTP Server . . .

Current Time: 2002-09-08 12:15:54

Schedule

Schedule

Use 24 hour clock. On all day: 00:00 to 24:00
 Off all day: All fields blank

Day	Session 1		Session 2	
	Start	Finish	Start	Finish
Monday	<input type="text" value="00:00"/>	<input type="text" value="12:00"/>	<input type="text" value="12:00"/>	<input type="text" value="24:00"/>
Tuesday	<input type="text" value="00:00"/>	<input type="text" value="12:00"/>	<input type="text" value="12:00"/>	<input type="text" value="24:00"/>
Wednesday	<input type="text" value="00:00"/>	<input type="text" value="12:00"/>	<input type="text" value="12:00"/>	<input type="text" value="24:00"/>
Thursday	<input type="text" value="00:00"/>	<input type="text" value="12:00"/>	<input type="text" value="12:00"/>	<input type="text" value="24:00"/>
Friday	<input type="text" value="00:00"/>	<input type="text" value="12:00"/>	<input type="text" value="12:00"/>	<input type="text" value="24:00"/>
Saturday	<input type="text" value="00:00"/>	<input type="text" value="12:00"/>	<input type="text" value="12:00"/>	<input type="text" value="24:00"/>
Sunday	<input type="text" value="00:00"/>	<input type="text" value="12:00"/>	<input type="text" value="12:00"/>	<input type="text" value="24:00"/>

Local Time

Time Zone: (GMT) Greenwich Mean Time : Edinburgh, London

Adjust for Daylight Savings Time
 Use this NTP Server . . .

Current Time: 2002-09-08 12:22:18 Weekday : Sunday

Default Schedule

Schedule

Time Zone

Every Day

Sunday

Monday

Tuesday

Wednesday

Thursday

Friday

Saturday

Time of day: (use 24-hour clock)

All Day

Start Time Hour Minute

End Time Hour Minute

▼

Adjust for Daylight Savings Time

Use this NTP Server . . .

Current Time: 2002-09-08 13:08:09

Figure 60: Schedule Screen

Data - Schedule Screen

Schedule	
<u>Day</u>	<u>Each day of the week can scheduled independently.</u>
<u>Session 1</u> <u>Session 2</u>	<u>Two (2) separate sessions or periods can be defined. Session 2 can be left blank if not required.</u>
<u>Start Time</u>	<u>Enter the start using a 24 hr clock.</u>
<u>Finish Time</u>	<u>Enter the finish time using a 24 hr clock.</u>
Local Time	
Time Zone	In order to display your local time correctly, you must select your "Time Zone" from the list.
Adjust for Daylight Savings Time	If your region uses Daylight Savings Time, you must manually check "Adjust for Daylight Savings Time" at the beginning of the adjustment period, and uncheck it at the end of the Daylight Savings period.
Use this NTP Server	If you prefer to use a particular NTP server as the primary NTP server, check the checkbox "Use this NTP Server" and enter the Server's IP address in the fields provided.. If this setting is not enabled, the default NTP Servers are used.
Current Time	This displays the current time on the 54Mbps 802.11g ADSL Fire-wall Modem Router, at the time the page is loaded.

Schedule	
Sunday, Monday...	Use these checkboxes to select the desired days.
Start Time	Enter the start using a 24 hr clock.
Finish Time	Enter the finish time using a 24 hr clock.
Local Time	
Time Zone	In order to display your local time correctly, you must select your "Time Zone" from the list.
Adjust for Daylight Savings Time	If your region uses Daylight Savings Time, you must manually check "Adjust for Daylight Savings Time" at the beginning of the adjustment period, and uncheck it at the end of the Daylight Savings period.
Use this NTP Server	If you prefer to use a particular NTP server as the primary server, check the checkbox "Use this NTP Server" and enter the Server's IP address in the fields provided. If this setting is not enabled, the default NTP Servers are used.
Current Time	This displays the current time on the Wireless ADSL Router.

Virtual Servers

This feature, sometimes called *Port Forwarding*, allows you to make Servers on your LAN accessible to Internet users. Normally, Internet users would not be able to access a server on your LAN because:

- Your Server does not have a valid external IP Address.
- Attempts to connect to devices on your LAN are blocked by the firewall in this device.

The "Virtual Server" feature solves these problems and allows Internet users to connect to your servers, as illustrated below.

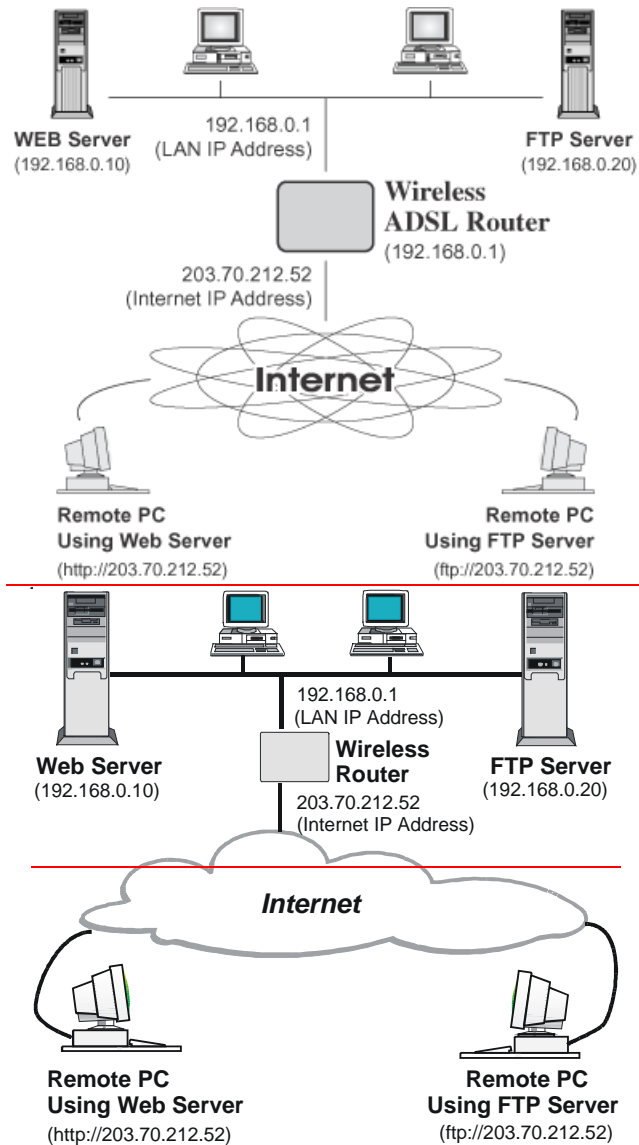

Figure 61: Virtual Servers

IP Address seen by Internet Users

Note that, in this illustration, both Internet users are connecting to the same IP Address, but using different protocols.

To Internet users, all virtual Servers on your LAN have the same IP Address. This IP Address is allocated by your ISP.

This address should be static, rather than dynamic, to make it easier for Internet users to connect to your Servers.

However, you can use the *DDNS (Dynamic DNS)* feature to allow users to connect to your Virtual Servers using a URL, instead of an IP Address.

Virtual Servers Screen

- The "Virtual Servers" feature allows Internet Users to access PCs on your LAN.
- The PCs must be running the appropriate Server Software.
- For Internet Users, ALL of your Servers have the same IP address. This IP address is allocated by your ISP.
- To make it easier for Internet users to connect to your Servers, you can use the "DDNS" feature. This allows Internet users to connect to your Servers with a URL, rather than an IP address. This technology works even if your ISP allocates dynamic IP addresses (IP address is allocated upon connection, so it may change each time you connect).

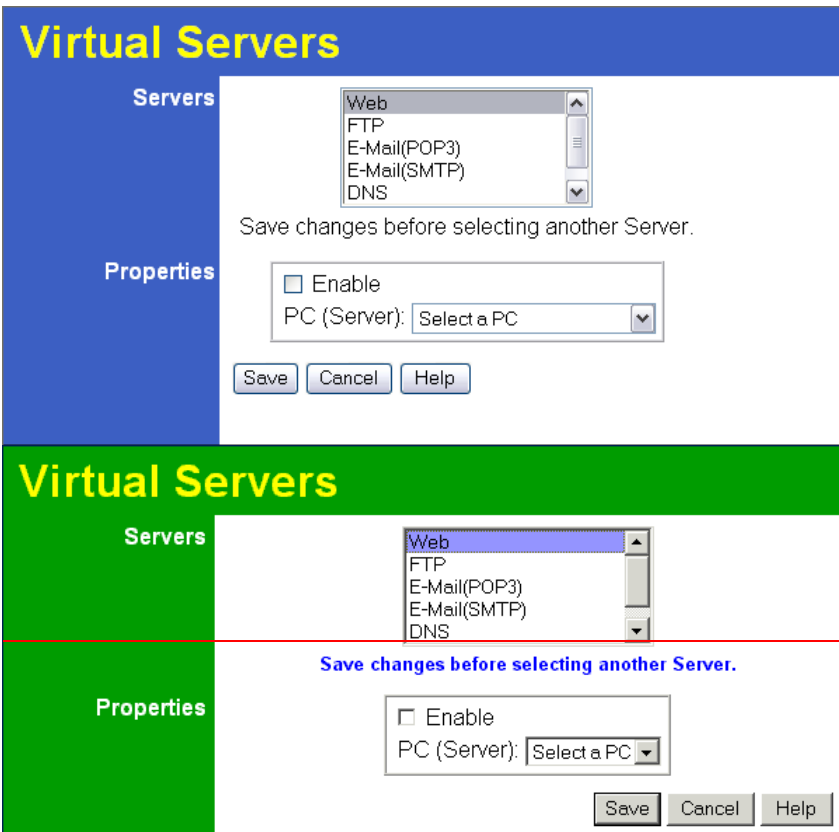

Figure 62: Virtual Servers Screen

Data - Virtual Servers Screen

Servers	
Servers	This lists a number of common Server types. If the desired Server type is not listed, you can create a Firewall Rule to achieve the same effect as the Virtual Server function.

Properties	
Enable	Use this to Enable or Disable support for this Server, as required. If Enabled, you must select the PC to which this traffic will be sent.
PC (Server)	Select the PC for this Server. The PC must be running the appropriate Server software.



Note!

For each entry, the PC must be running the appropriate Server software.

If the desired Server type is not listed, you can define your own Servers, using the Firewall Rules.

Connecting to the Virtual Servers

Once configured, anyone on the Internet can connect to your Virtual Servers. They must use the Internet IP Address (the IP Address allocated to you by your ISP).

e.g.

http://203.70.212.52

ftp://203.70.212.52

It is more convenient if you are using a Fixed IP Address from your ISP, rather than Dynamic. However, you can use the *Dynamic DNS* feature to allow users to connect to your Virtual Servers using a URL, rather than an IP Address.



Note!

From the Internet, ALL Virtual Servers have the IP Address allocated by your ISP

Chapter 7

Advanced Administration



This Chapter explains the settings available via the "Administration" section of the menu.

Overview

Normally, it is not necessary to use these screens, or change any settings. These screens and settings are provided to deal with non-standard situations, or to provide additional options for advanced users.

The available settings and features are:

PC Database This is the list of PCs shown when you select the "DMZ PC" or a "Virtual Server". This database is maintained automatically, but you can add and delete entries for PCs which use a Fixed (Static) IP Address.

Config File Backup or restore the configuration file for the 54Mbps 802.11g ADSL Firewall Modem Router. This file contains all the configuration data.

~~Logs~~ Logs & Email View or clear all logs, set E-Mailing of log files and alerts.

~~PC Database~~ ~~This is the list of PCs shown when you select the "DMZ PC" or a "Virtual Server". This database is maintained automatically, but you can add and delete entries for PCs which use a Fixed (Static) IP Address.~~

~~Network~~ Diagnostics Perform a Ping or DNS Lookup.

~~Remote~~ Administration Allow settings to be changed from the Internet.

Routing Only required if your LAN has other Routers or Gateways.

~~Firmware~~ Upgrade Firmware Upgrade the Firmware (software) installed in your 54Mbps 802.11g ADSL Firewall Modem Router.

PC Database

The PC Database is used whenever you need to select a PC (e.g. for the "DMZ" PC).

- It eliminates the need to enter IP addresses.
- Also, you do not need to use fixed IP addresses on your LAN.

However, if you do use a fixed IP address on some devices on your LAN, you should enter details of each such device into the PC database, using the PC Database screen.

PC Database Screen

An example *PC Database* screen is shown below.

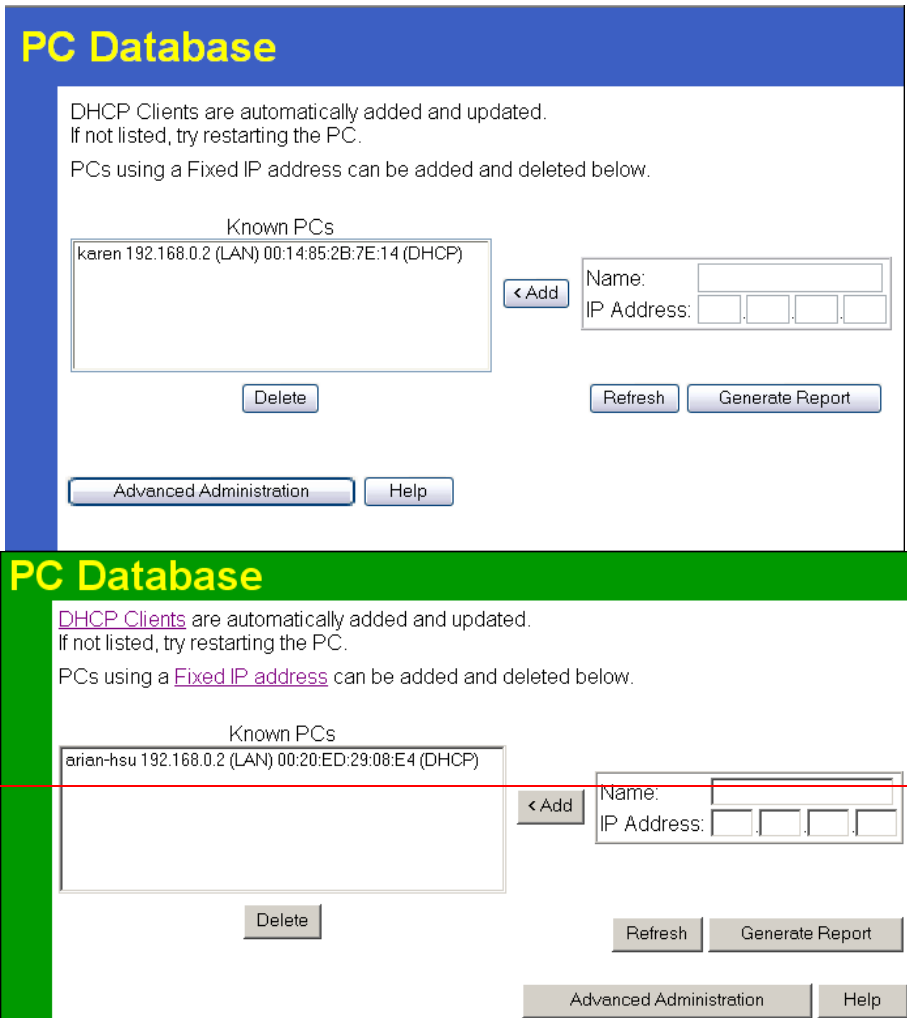

Figure 63: PC Database

- PCs which are "DHCP Clients" are automatically added to the database, and updated as required.
- By default, non-Server versions of Windows act as "DHCP Clients"; this setting is called "Obtain an IP Address automatically".
- The 54Mbps 802.11g ADSL Firewall Modem Router uses the "Hardware Address" to identify each PC, not the name or IP address. The "Hardware Address" can only change if you change the PC's network card or adapter.

- This system means you do NOT need to use Fixed (static) IP addresses on your LAN. However, you can add PCs using Fixed (static) IP Addresses to the PC database if required.

Data - PC Database Screen

Known PCs	This lists all current entries. Data displayed is <i>name (IP Address) type</i> . The "type" indicates whether the PC is connected to the LAN.
Name	If adding a new PC to the list, enter its name here. It is best if this matches the PC's "hostname".
IP Address	Enter the IP Address of the PC. The PC will be sent a "ping" to determine its hardware address. If the PC is not available (not connected, or not powered On) you will not be able to add it.
Buttons	
Add	This will add the new PC to the list. The PC will be sent a "ping" to determine its hardware address. If the PC is not available (not connected, or not powered On) you will not be able to add it.
Delete	Delete the selected PC from the list. This should be done in 2 situations: <ul style="list-style-type: none">• The PC has been removed from your LAN.• The entry is incorrect.
Refresh	Update the data on screen.
Generate Report	Display a read-only list showing full details of all entries in the PC database.
Advanced Administration	View the Advanced version of the PC database screen - <i>PC Database (Admin)</i> . See below for details.

PC Database - Advanced

This screen is displayed if the "Advanced Administration" button on the *PC Database* is clicked. It provides more control than the standard *PC Database* screen.

PC Database - Advanced

Any PC may be added, edited or deleted. If adding a PC which is not connected and On, you must provide the MAC (hardware) address

Known PCs

karen 192.168.0.2 (LAN) 00:14:85:2B:7E:14 (DHCP)

PC Properties

Name:

IP Address: Automatic (DHCP Client)
 DHCP Client - reserved IP address: ...

Fixed IP address (set on PC): ...

MAC Address: Automatic discovery (PC must be available on LAN)
 MAC address is

PC Database

Any PC may be added, edited or deleted. If adding a PC which is not connected and On, you must provide the MAC (hardware) address

Known PCs

arian-hsu 192.168.0.2 (LAN) 00:20:ED:29:08:E4 (DHCP)

PC Properties

Name:

IP Address: Automatic (DHCP Client)
 DHCP Client - reserved IP address: ...

Fixed IP address (set on PC): ...

MAC Address: Automatic discovery (PC must be available on LAN)
 MAC address is

Figure 64: PC Database (Admin)

Data - Advanced PC Database

Known PCs	This lists all current entries. Data displayed is <i>name (IP Address) type</i> . The "type" indicates whether the PC is connected to the LAN.
PC Properties	
Name	If adding a new PC to the list, enter its name here. It is best if this matches the PC's "hostname".
IP Address	<p>Select the appropriate option:</p> <ul style="list-style-type: none"> • Automatic - The PC is set to be a DHCP client (Windows: "Obtain an IP address automatically"). The 54Mbps 802.11g ADSL Firewall Modem Router will allocate an IP address to this PC when requested to do so. The IP address could change, but normally won't. • DCHP Client - Reserved IP Address - Select this if the PC is set to be a DCHP client, and you wish to guarantee that the 54Mbps 802.11g ADSL Firewall Modem Router will always allocate the same IP Address to this PC. Enter the required IP address. • Fixed IP Address - Select this if the PC is using a Fixed (Static) IP address. Enter the IP address allocated to the PC. (The PC itself must be configured to use this IP address.)
MAC Address	<p>Select the appropriate option</p> <ul style="list-style-type: none"> • Automatic discovery - Select this to have the 54Mbps 802.11g ADSL Firewall Modem Router contact the PC and find its MAC address. This is only possible if the PC is connected to the LAN and powered On. • MAC address is - Enter the MAC address on the PC. The MAC address is also called the "Hardware Address", "Physical Address", or "Network Adapter Address". The 54Mbps 802.11g ADSL Firewall Modem Router uses this to provide a unique identifier for each PC. Because of this, the MAC address can NOT be left blank.
Buttons	
Add as New Entry	Add a new PC to the list, using the data in the "Properties" box. If "Automatic discovery" (for MAC address) is selected, the PC will be sent a "ping" to determine its hardware address. This will fail unless the PC is connected to the LAN, and powered on.
Update Selected PC	Update (modify) the selected PC, using the data in the "Properties" box.
Clear Form	Clear the "Properties" box, ready for entering data for a new PC.
Refresh	Update the data on screen.
Generate Report	Display a read-only list showing full details of all entries in the PC database.
Standard Screen	Click this to view the standard <i>PC Database</i> screen.

Config File

This feature allows you to download the current settings from the 54Mbps 802.11g ADSL Firewall Modem Router, and save them to a file on your PC.

You can restore a previously-downloaded configuration file to the 54Mbps 802.11g ADSL Firewall Modem Router, by uploading it to the 54Mbps 802.11g ADSL Firewall Modem Router.

This screen also allows you to set the 54Mbps 802.11g ADSL Firewall Modem Router back to its factory default configuration. Any existing settings will be deleted.

An example *Config File* screen is shown below.

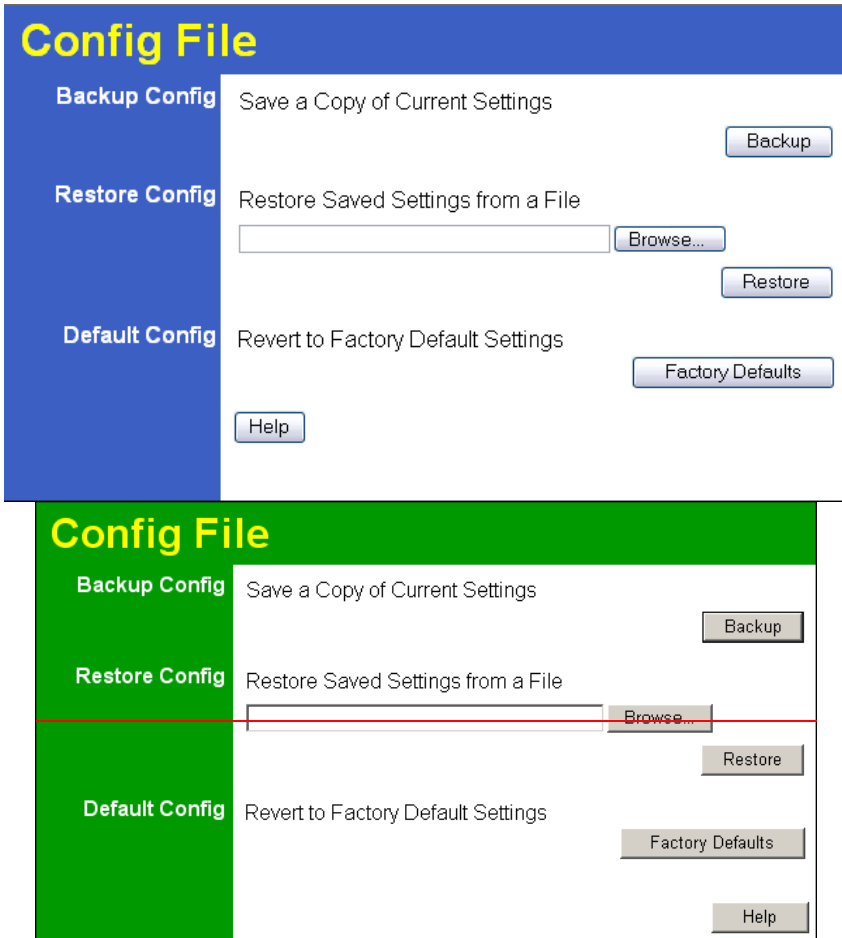

Figure 65: Config File Screen

Data - Config File Screen

Backup Config	Use this to download a copy of the current configuration, and store the file on your PC. Click <i>Backup</i> to start the download.
----------------------	---

Restore Config	<p>This allows you to restore a previously-saved configuration file back to the 54Mbps 802.11g ADSL Firewall Modem Router.</p> <p>Click <i>Browse</i> to select the configuration file, then click <i>Restore</i> to upload the configuration file.</p> <p>WARNING!</p> <p>Uploading a configuration file will destroy (overwrite) ALL of the existing settings.</p>
Default Config	<p>Clicking the <i>Factory Defaults</i> button will reset the 54Mbps 802.11g ADSL Firewall Modem Router to its factory default settings.</p> <p>WARNING!</p> <p>This will delete ALL of the existing settings.</p>

LogsLogs

The Logs record various types of activity on the 54Mbps 802.11g ADSL Firewall Modem Router. This data is useful for troubleshooting, but enabling all logs will generate a large amount of data and adversely affect performance.

Since only a limited amount of log data can be stored in the 54Mbps 802.11g ADSL Firewall Modem Router, log data can also be E-mailed to your PC. Use the *E-mail* screen to configure this feature.

Logs

Logs Current time: 2002-09-08 12:24:39

```
Sun, 2002-09-08 12:09:59 - client 192.168.0.2
Sun, 2002-09-08 12:00:00 - Router start up
Sun, 2002-09-08 12:11:26 - client 192.168.0.2
Sun, 2002-09-08 12:20:22 - client 192.168.0.2
```

Include in Log

- Attempted access to blocked sites
- Connections to the Web-based interface of this Router
- Router operation (start up, get time etc)
- Known DoS attacks and Port Scans

Syslog

- Disable
- Broadcast on LAN
- Send to this Syslog Server: . . .

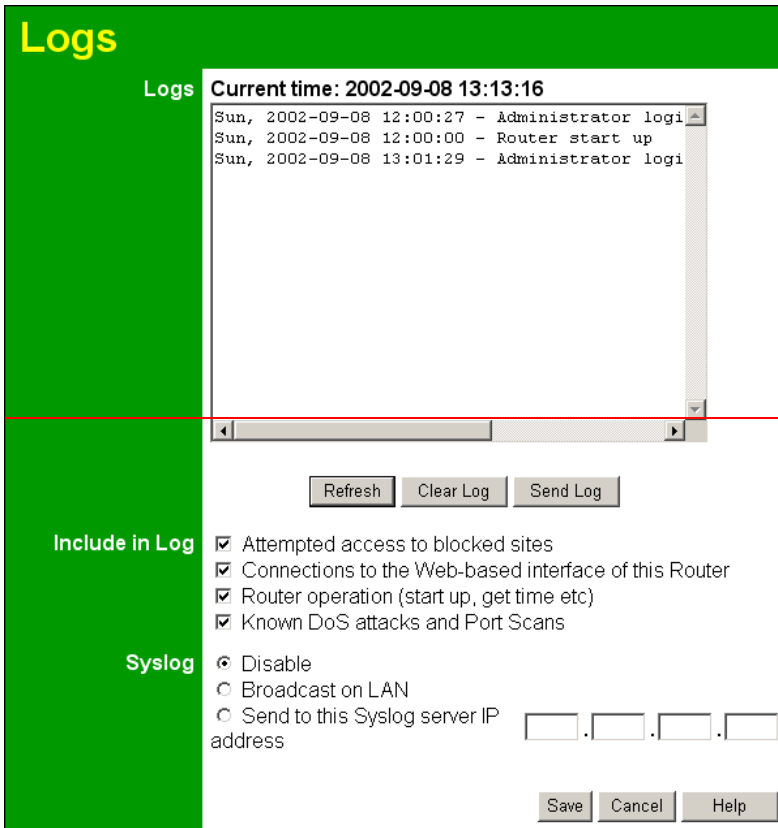

Figure 66: ~~Logs~~ Logs Screen

Data - ~~Logs~~ Logs Screen

Logs	
Current Time	The current time on the 54Mbps 802.11g ADSL Firewall Modem Router is displayed.
Log Data	Current log data is displayed in this panel.
Buttons	<p>There are three (3) buttons</p> <ul style="list-style-type: none"> • Refresh - Update the log data. • Clear Log - Clear the log, and restart it. This makes new messages easier to read. • Send Log - E-mail the log immediately. This is only functional if the <i>E-mail</i> screen has been configured.

Logs	
Include (Checkboxes)	<p>Use these checkboxes to determine which events are included in the log. Checking all options will increase the size of the log, so it is good practice to disable any events which are not really required.</p> <ul style="list-style-type: none"> • Attempted access to blocked sites - If checked, attempted Internet accesses which were blocked are logged. • Connections to the Web-based interface of this Router - If checked, this will log connections TO this Router, rather than through this Router to the Internet. • Router operation - If checked, other Router operations (not covered by the selections above) will be logged. • Known DoS attacks and Port Scans - If checked, Denial of Service attacks, as well as port scans, will be logged.
Syslog	
Disable	Data is not sent to a Syslog Server.
Broadcast on LAN	The Syslog data is broadcast, rather than sent to a specific Syslog server. Use this if your Syslog Server does not have a fixed IP address.
Send to this Syslog Server	If your Syslog server has a fixed IP address, select this option, and enter the IP address of your Syslog server.

E-mail

This screen allows you to E-mail Logs and Alerts. A sample screen is shown below.

E-Mail

E-mail Notification

Turn E-mail Notification On

Send to this E-mail Address:

Outgoing (SMTP) Mail Server:

My SMTP Mail Server requires authentication

User Name:

Password:

E-mail Alerts

Send E-Mail alerts immediately

If a DoS attack is detected.

If a Port Scan is detected.

If someone attempts to access a blocked site.

E-mail Logs

Send Logs According to this Schedule

Hourly

Day Sunday

Time 1:00 a.m. p.m.

E-Mail

E-mail Notification

Turn E-mail Notification On

Send To This E-mail Address:

Outgoing Mail Server:

E-mail Alerts

Send E-Mail alerts immediately

If a DoS attack is detected.

If a Port Scan is detected.

If someone attempts to access a blocked site.

E-mail Logs

Send Logs According to this Schedule

When Log is Full

Day

Time a.m. p.m.

Figure 67: E-mail Screen

Data - E-mail Screen

E-Mail Notification	
<u>Turn E-mail Notification on</u>	<u>Check this box to enable this feature. If enabled, the E-mail address information (below) must be provided.</u>
<u>Send Alerts and Logs Via this E-mail address</u>	<u>Enter the E-mail address the Log is to be sent to. The E-mail will also show this address as the Sender's address. Check this box to enable this feature. If enabled, the E-mail address information (below) must be provided.</u>
<u>Outgoing (SMTP) Mail Server</u>	Enter the address or IP address of the SMTP (Simple Mail Transport Protocol) Server you use for outgoing E-mail.
<u>My SMTP Mail Server requires authentication</u>	<u>To stop spammers, many SMTP mail servers require you to log in to send mail. In this case, enable this checkbox, and enter the login information (User name and Password) in the fields below.</u>
<u>User Name</u>	<u>If you have enabled "My SMTP Mail Server requires authentication" above, enter the User Name required to login to your SMTP Server.</u>
<u>Password</u>	<u>If you have enabled "My SMTP Mail Server requires authentication" above, enter the password required to login to your SMTP Server.</u>
E-mail Alerts	
Send E-mail alerts immediately	<p>You can choose to have alerts E-mailed to you, by checking the desired checkboxes. The Broadband ADSL Router can send an immediate alert when it detects a significant security incident such as</p> <ul style="list-style-type: none"> • A known hacker attack is directed at your IP address • A computer on the Internet scans your IP address for open ports • Someone on your LAN (Local Area Network) tries to visit a blocked site.
E-mail Logs	
Send Logs	<p>Select the desired option for sending the log by E-mail.</p> <ul style="list-style-type: none"> • Never (default) - This feature is disabled; Logs are not sent. • When log is full - The time is not fixed. The log will be sent when the log is full, which will depend on the volume of traffic. • Hourly, Daily, Weekly... - The log is sent on the interval specified. <ul style="list-style-type: none"> • If Daily is selected, the log is sent at the time specified. Select the time of day you wish the E-mail to be sent. • If Weekly is selected, the log is sent once per week, on the specified day, at the specified time. Select the day and the time of day you wish the E-mail to be sent. <p>Note:</p> <p><input type="checkbox"/> If the log is full before the time specified to send it, it will be sent regardless of the day and time specified.</p>

Network Diagnostics

This screen allows you to perform a "Ping" or a "DNS lookup". These activities can be useful in solving network problems.

An example *Network Diagnostics* screen is shown below.

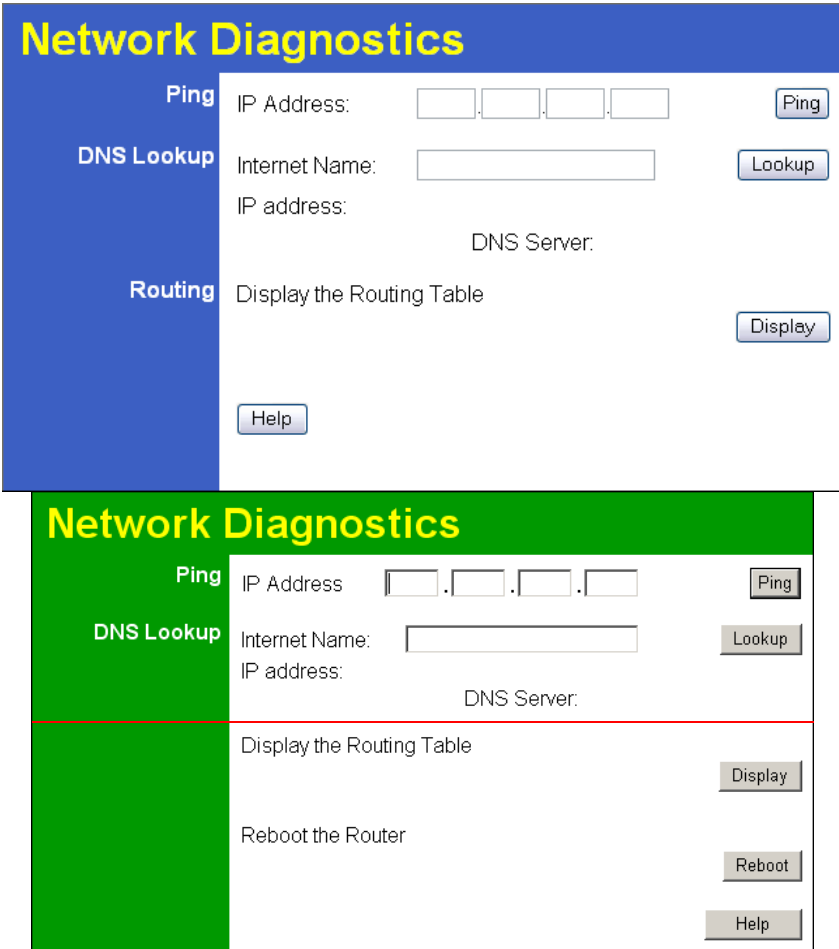

Figure 68: Network Diagnostics Screen

Data - Network Diagnostics Screen

Ping	
IP Address	Enter the IP address you wish to ping. The IP address can be on your LAN, or on the Internet. Note that if the address is on the Internet, and no connection currently exists, you could get a "Timeout" error. In that case, wait a few seconds and try again.
Ping Button	After entering the IP address, click this button to start the "Ping" procedure. The results will be displayed in the <i>Ping Results</i> pane.

DNS Lookup	
Internet name	Enter the Domain name or URL for which you want a DNS (Domain Name Server) lookup. Note that if the address is on the Internet, and no connection currently exists, you could get a "Timeout" error. In that case, wait a few seconds and try again.
Lookup Button	After entering the Domain name/URL, click this button to start the "DNS Lookup" procedure.
Routing	
Display	Click this button to display the internal routing table. This information can be used by Technical Support and other staff who understand Routing Tables.

Remote Administration

If enabled, this feature allows you to manage the 54Mbps 802.11g ADSL Firewall Modem Router via the Internet.

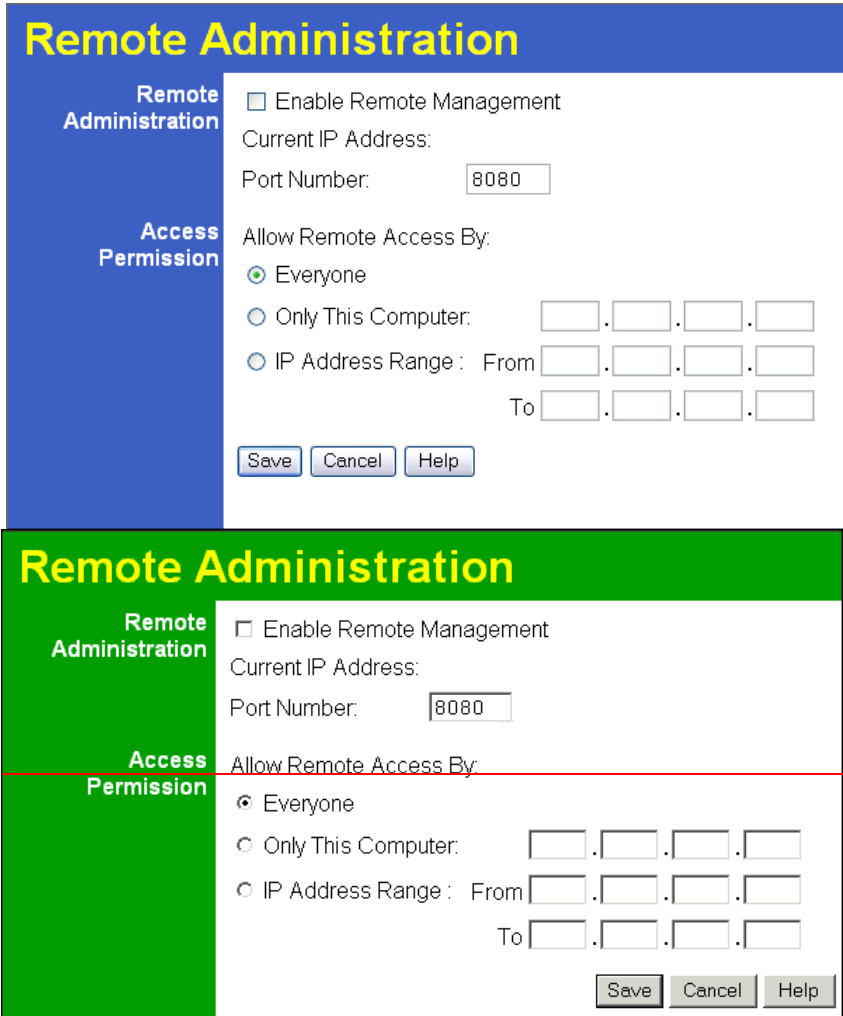

Figure 69: Remote Administration Screen

Data - Remote Administration Screen

Remote Administration	
Enable Remote Management	<p>Check to allow administration/management via the Internet. (To connect, see below).</p> <p>If Disabled, this device will ignore Administration connection attempts from the Internet.</p>
Current IP Address	<p>This is the current address you will use when accessing this device from the Internet. To connect, see details and an example below.</p>
Port Number	<p>Enter a port number between 1 and 65535. The default for HTTP (Web) connections is port 80, but using port 80 will prevent the use of a Web "Virtual Server" on your LAN. So using a different port</p>

	<p>number is recommended. The default value is 8080.</p> <p>The port number must be specified in your Browser when you connect. See the following section for details.</p>
Access Permission	
<p>Allow Remote Access</p>	<p>Select the desired option.</p> <ul style="list-style-type: none"> • Everyone - allow access by everyone on the Internet. • Only This Computer - allow access by only one IP address. Enter the desired IP address. • IP Address Range - allow access from a range of IP addresses on the Internet. Enter a beginning and ending IP address to define the allowed range. <p>For security, you should restrict access to as few external IP addresses as practical.</p>

To connect from a remote PC via the Internet

1. Ensure your Internet connection is established, and start your Web Browser.
2. In the "Address" bar, enter "HTTP://" followed by the Internet IP Address of the 54Mbps 802.11g ADSL Firewall Modem Router. If the port number is not 80, the port number is also required. (After the IP Address, enter ":" followed by the port number.)
e.g.

HTTP://123.123.123.123:8080

This example assumes the WAN IP Address is 123.123.123.123, and the port number is 8080.

3. You will then be prompted for the login name and password for this device.

Routing

Overview

- If you don't have other Routers or Gateways on your LAN, you can ignore the "Routing" page completely.
- If the 54Mbps 802.11g ADSL Firewall Modem Router is only acting as a Gateway for the local LAN segment, ignore the "Routing" page even if your LAN has other Routers.
- If your LAN has a standard Router (e.g. Cisco) on your LAN, and the 54Mbps 802.11g ADSL Firewall Modem Router is to act as a Gateway for all LAN segments, enable RIP (Routing Information Protocol) and ignore the Static Routing table.
- If your LAN has other Gateways and Routers, and you wish to control which LAN segments use each Gateway, do NOT enable RIP (Routing Information Protocol). Configure the Static Routing table instead. (You also need to configure the other Routers.)
- If using Windows 2000 Data center Server as a software Router, enable RIP on the 54Mbps 802.11g ADSL Firewall Modem Router, and ensure the following Windows 2000 settings are correct:
 - Open *Routing and Remote Access*
 - In the console tree, select *Routing and Remote Access*, [server name], *IP Routing*, *RIP*
 - In the "Details" pane, right-click the interface you want to configure for RIP version 2, and then click "Properties".
 - On the "General" tab, set *Outgoing packet protocol* to "RIP version 2 broadcast", and *Incoming packet protocol* to "RIP version 1 and 2".

Routing Screen

The routing table is accessed by the *Routing* link on the *Administration* menu.

Using this Screen

Generally, you will use either RIP (Routing Information Protocol) OR the Static Routing Table, as explained above, although it is possible to use both methods simultaneously.

Static Routing Table

- If RIP is not used, an entry in the routing table is required for each LAN segment on your Network, other than the segment to which this device is attached.
- The other Routers must also be configured. See *Configuring Other Routers on your LAN* later in this chapter for further details and an example.

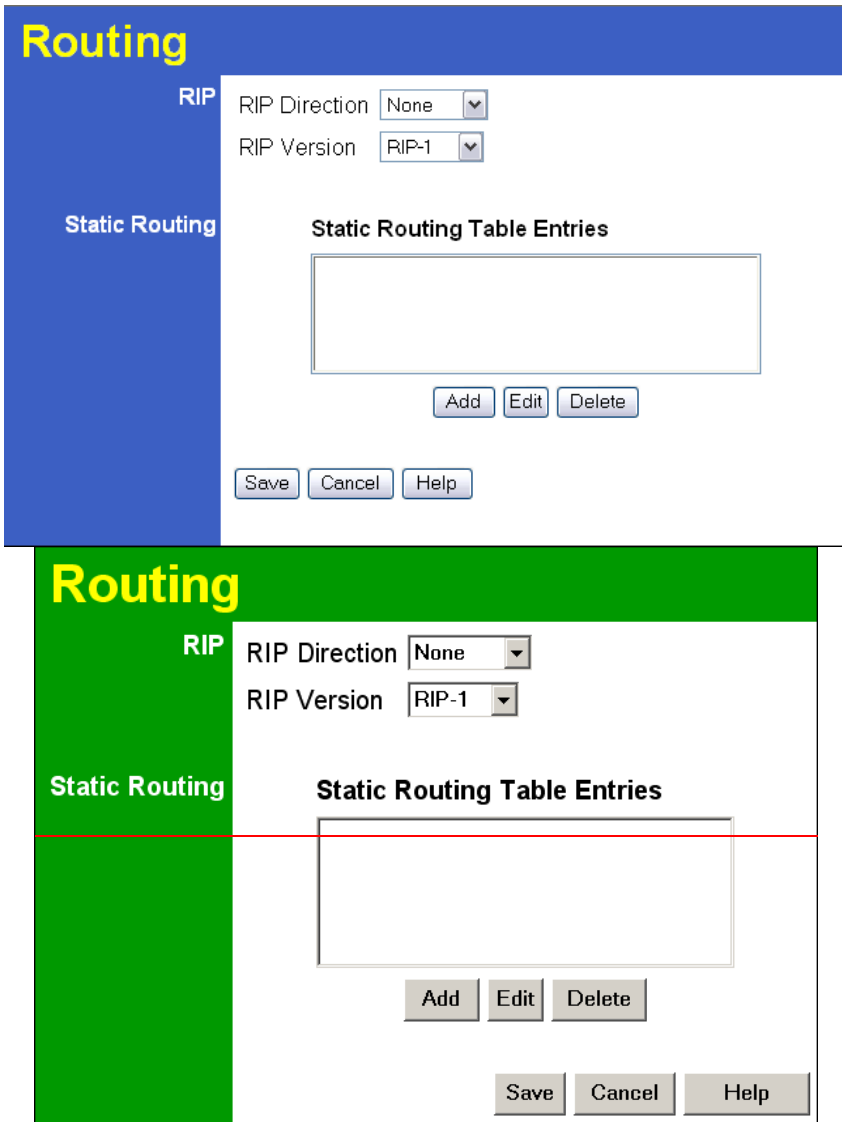

Figure 70: Routing Screen

Data - Routing Screen

RIP	
RIP Direction	Select the desired RIP Direction.
RIP Version	Choose the RIP Version for the Server.
Static Routing	
Static Routing Table Entries	<p>This list shows all entries in the Routing Table.</p> <ul style="list-style-type: none"> • This area shows details of the selected item in the list. • Change any the properties as required, then click the "Edit" button to save the changes to the selected entry.

Buttons	
Add	Add a new entry to the Static Routing table, using the data shown in the "Properties" area on screen. The entry selected in the list is ignored, and has no effect.
Edit	Update the current Static Routing Table entry, using the data shown in the table area on screen.
Delete	Delete the current Static Routing Table entry.
Save	Save the RIP setting. This has no effect on the Static Routing Table.

Configuring Other Routers on your LAN

It is essential that all IP packets for devices not on the local LAN be passed to the 54Mbps 802.11g ADSL Firewall Modem Router, so that they can be forwarded to the external LAN, WAN, or Internet. To achieve this, the local LAN must be configured to use the 54Mbps 802.11g ADSL Firewall Modem Router as the *Default Route* or *Default Gateway*.

Local Router

The local router is the Router installed on the same LAN segment as the 54Mbps 802.11g ADSL Firewall Modem Router. This router requires that the *Default Route* is the 54Mbps 802.11g ADSL Firewall Modem Router itself. Typically, routers have a special entry for the *Default Route*. It should be configured as follows.

Destination IP Address	Normally 0.0.0.0, but check your router documentation.
Network Mask	Normally 0.0.0.0, but check your router documentation.
Gateway IP Address	The IP Address of the 54Mbps 802.11g ADSL Firewall Modem Router.
Metric	1

Other Routers on the Local LAN

Other routers on the local LAN must use the 54Mbps 802.11g ADSL Firewall Modem Router's *Local Router* as the *Default Route*. The entries will be the same as the 54Mbps 802.11g ADSL Firewall Modem Router's local router, with the exception of the *Gateway IP Address*.

- For a router with a direct connection to the 54Mbps 802.11g ADSL Firewall Modem Router's local Router, the *Gateway IP Address* is the address of the 54Mbps 802.11g ADSL Firewall Modem Router's local router.
- For routers which must forward packets to another router before reaching the 54Mbps 802.11g ADSL Firewall Modem Router's local router, the *Gateway IP Address* is the address of the intermediate router.

Static Routing - Example

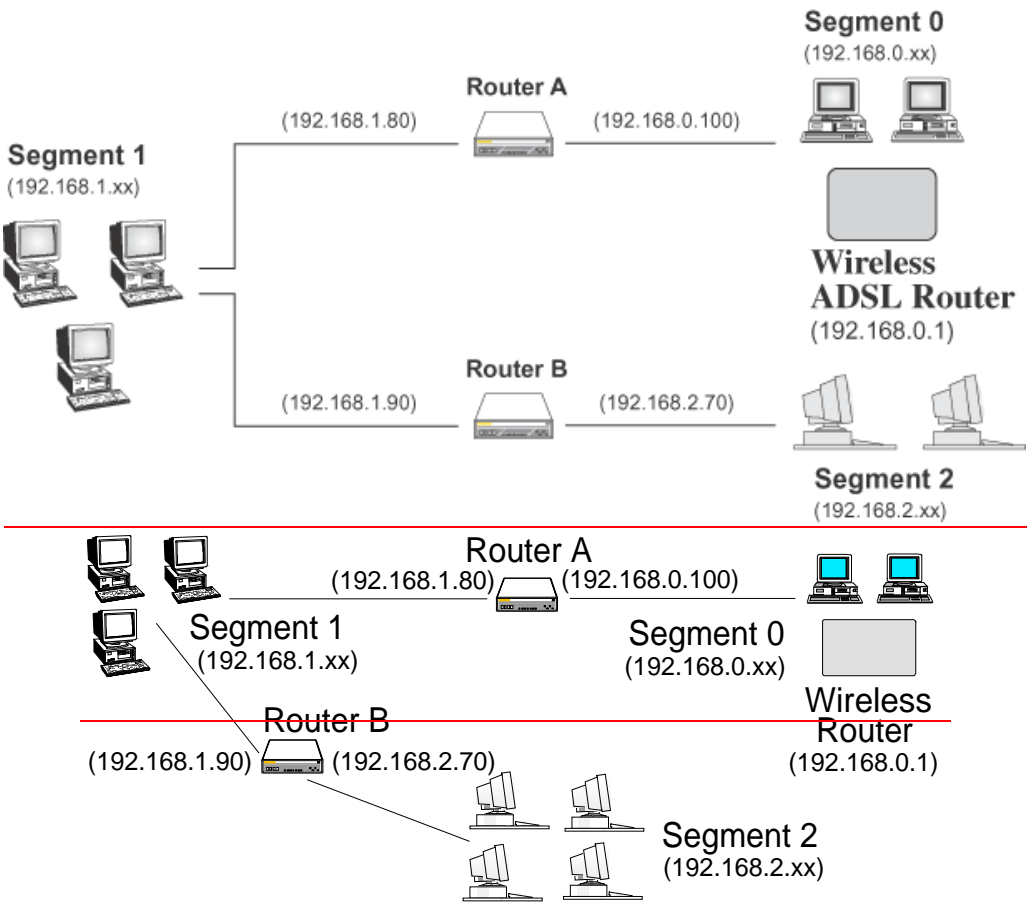

Figure 71: Routing Example

For the 54Mbps 802.11g ADSL Firewall Modem Router's Routing Table

For the LAN shown above, with 2 routers and 3 LAN segments, the 54Mbps 802.11g ADSL Firewall Modem Router requires 2 entries as follows.

Entry 1 (Segment 1)	
Destination IP Address	192.168.1.0
Network Mask	255.255.255.0 (Standard Class C)
Gateway IP Address	192.168.0.100 (54Mbps 802.11g ADSL Firewall Modem Router's local Router)
Metric	2
Entry 2 (Segment 2)	
Destination IP Address	192.168.2.0
Network Mask	255.255.255.0 (Standard Class C)
Gateway IP Address	192.168.0.100
Metric	3

For Router A's Default Route

Destination IP Address	0.0.0.0
Network Mask	0.0.0.0
Gateway IP Address	192.168.0.1 (54Mbps 802.11g ADSL Firewall Modem Router's IP Address)

For Router B's Default Route

Destination IP Address	0.0.0.0
Network Mask	0.0.0.0
Gateway IP Address	192.168.1.80 (54Mbps 802.11g ADSL Firewall Modem Router's local router)

Upgrade Firmware

The firmware (software) in the 54Mbps 802.11g ADSL Firewall Modem Router can be upgraded using your Web Browser.

You must first download the upgrade file, then select *Upgrade Firmware* on the *Administration* menu. You will see a screen like the following.

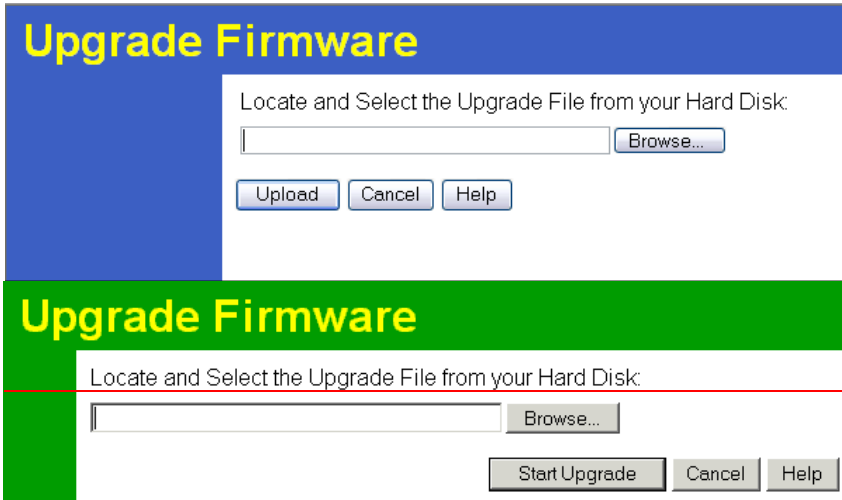

Figure 72: Router Upgrade Screen

To perform the Firmware Upgrade:

1. Click the *Browse* button and navigate to the location of the upgrade file.
2. Select the upgrade file. Its name will appear in the *Upgrade File* field.
3. Click the *Upload* button to commence the firmware upgrade.



Note!

The 54Mbps 802.11g ADSL Firewall Modem Router is unavailable during the upgrade process, and must restart when the upgrade is completed. Any connections to or through the 54Mbps 802.11g ADSL Firewall Modem Router will be lost.

Chapter 8

Modem Mode

8

This Chapter explains configuration and operation when in "Modem" or "Bridge" mode..

Overview

There are two modes available on the **Mode** screen.

- **Router** - Both the ADSL Modem and the Router features are operational. In this mode, this device can provide shared Internet Access to all your LAN users. Also, by default, it acts a DHCP Server, providing an IP address and related information to all Wireless and LAN users.
- **Modem** - Only the ADSL Modem component is operational. All Router features are disabled. This device is "transparent" - it does not perform any operations or make any changes to the network traffic passing through it. You need to have a DHCP Server on your LAN to provide IP addresses to the Wireless clients using this Access Point.

This Chapter describes operation while in **Modem Mode**, also called **Bridge Mode**.

Management Connections

When this device restarts in Modem mode, the IP address does not change, but the DHCP server is disabled. However, your PC will usually retain the IP address provided by the DHCP Server, so the connection will be automatically re-established. You then need to ensure that the IP address of this modem is suitable for your LAN.

- You need to have a DHCP Server on your LAN to provide IP addresses to the Wireless clients using this Access Point.
- This Modem/AP must be a valid device on your LAN, to allow management connections. You must assign a (fixed) IP address which is within the address range used on your LAN, but not within the address range used by your DHCP server.

When you connect in future, just connect normally, using the IP address you assigned.

2.1. Start your WEB browser.

3.2. In the *Address* box, enter "HTTP://" and the current IP Address of the Wireless ADSL Modem, as in this example, which uses the Wireless ADSL Modem's default IP Address:
HTTP://192.168.0.1

4.3. When prompted for the User name and Password, enter *admin* for the user name, and the current password, as set on the password screen. (The password is the same regardless of the mode.)

Home Screen

If in Modem mode, the home screen will look like the example below.

TEW-435BRM (ANNEX A)		
Wireless:	SSID:	default
	Security:	Disabled
LAN:	IP Address:	192.168.0.1

Figure 73: Home Screen - Modem Mode

Note that the menu has changed, many of the options in Router mode are not available. The screens available are:

- **Mode** - change back to Router mode, if desired.
- **ADSL** - set ADSL parameters. See the following section for details.
- **LAN** - set IP address, mask and gateway. This is the same as in Router mode, except that the DHCP server is not available while in Modem mode.
- **Wireless** - this screen, and related sub-screens, is the same as in Router mode.
- **Password** - this screen is the same as in Router mode.
- **Upgrade Firmware** - this screen is the same as in Router mode.
- **Status** - displays current settings and status. See the following section for details.

Mode Screen

This screen is change back to Router mode, if desired.

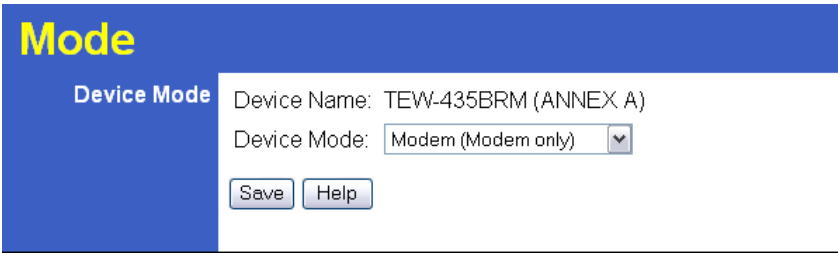

Figure 74: Mode Screen

Data - Mode Screen

Device Name	This field displays the current name of this device.
Device Mode	<p>Select the desired device mode for the router:</p> <ul style="list-style-type: none"> • Router - Both the ADSL Modem and the Router features are operational. In this mode, this device can provide shared Internet Access to all your LAN users. Also, by default, it acts a DHCP Server, providing an IP address and related information to all Wireless and LAN users. • Modem - Only the ADSL Modem component is operational. All Router features are disabled. This device is "transparent" - it does not perform any operations or make any changes to the network traffic passing through it. You need to have a DHCP Server on your LAN to provide IP addresses to the Wireless clients using this Access Point. This mode is also called <i>Bridge Mode</i>. <p>After changing the mode, this device will restart, which will take a few seconds. The menu will also change, depending on the mode you are in.</p>

ADSL Screen

This screen is used to set the ADSL parameter used by the modem.

Figure 75: ADSL Screen

Data - ADSL Screen

Multiplexing Method	Check with your ISP or DSL service provider to find whether your Multiplexing Method is VC-BASED or LLC-BASED.
VPI	Enter the value proposed by your ISP or DSL service provider.
VCI	Enter the value proposed by your ISP or DSL service provider.

Operation

Operation is automatic and transparent.

- Wireless clients can connect to the Access Point if they have the correct SSID and security, but they must obtain an IP address from the DHCP Server on your LAN.
- The modem will act like any other ADSL modem. No routing will be performed, and no client login will be done. If a client login is required, it must be performed by your Router/Gateway or by software on your PC.

Status Screen

In Modem mode, the Status screen looks like the example below.

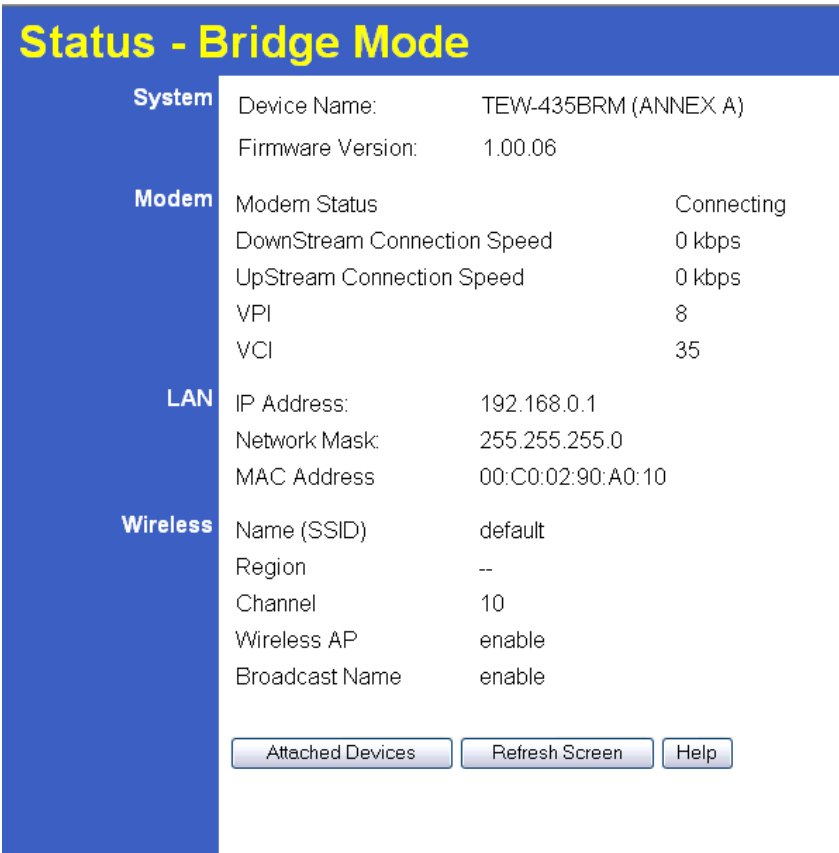

Figure 76: Status Screen - Bridge Mode

Data - Status Screen (Bridge Mode)

System	
Device Name	The current name of the Router. This name is also the "hostname" for users with an "@Home" type connection.
Firmware Version	<u>The version of the current firmware installed.</u>
ModemInternet	
Modem Status	This indicates the status of the ADSL modem component.
DownStream Connection Speed	Displays the speed for the DownStream Connection.
UpStream Connection Speed	If connected, displays the speed for the Up_Stream (upload) ADSL Connection.
VPI	This displays the current VPI setting used for the ADSL connection.
VCI	This displays the current VCI setting used for the ADSL connection.

LAN	
IP Address	The IP Address of the 54Mbps 802.11g ADSL Firewall Modem Router.
Network Mask	The Network Mask (Subnet Mask) for the IP Address above.
MAC Address	This shows the MAC Address for the 54Mbps 802.11g ADSL Firewall Modem Router, as seen on the LAN interface.
Wireless	
Name (SSID)	If using an ESS (Extended Service Set, with multiple access points) this ID is called an ESSID (Extended Service Set Identifier).
Region	The current region, as set on the Wireless screen.
Channel	This shows the Channel currently used, as set on the Wireless screen.
Wireless AP	This indicates whether or not the Wireless Access Point feature is enabled.
Broadcast Name	This indicates whether or not the SSID is Broadcast. This setting is on the Wireless screen.
System	
Device Name	The current name of the Wireless ADSL Router. This is also the "hostname" provided to ISPs who request this information.
Firmware Version	The version of the current firmware installed.
Buttons	
Attached Devices	Clicking this will generate a list of all devices currently using the Access Point.
Refresh Screen	Update the data displayed on screen.

Appendix A

Troubleshooting



This Appendix covers the most likely problems and their solutions.

Overview

This chapter covers some common problems that may be encountered while using the 54Mbps 802.11g ADSL Firewall Modem Router and some possible solutions to them. If you follow the suggested steps and the 54Mbps 802.11g ADSL Firewall Modem Router still does not function properly, contact your dealer for further advice.

General Problems

Problem 1: Can't connect to the 54Mbps 802.11g ADSL Firewall Modem Router to configure it.

Solution 1: Check the following:

- The 54Mbps 802.11g ADSL Firewall Modem Router is properly installed, LAN connections are OK, and it is powered ON.
- Ensure that your PC and the 54Mbps 802.11g ADSL Firewall Modem Router are on the same network segment. (If you don't have a router, this must be the case.)
- If your PC is set to "Obtain an IP Address automatically" (DHCP client), restart it.
- If your PC uses a Fixed (Static) IP address, ensure that it is using an IP Address within the range 192.168.0.2 to 192.168.0.254 and thus compatible with the 54Mbps 802.11g ADSL Firewall Modem Router's default IP Address of 192.168.0.1.

Also, the Network Mask should be set to 255.255.255.0 to match the 54Mbps 802.11g ADSL Firewall Modem Router.

In Windows, you can check these settings by using *Control Panel-Network* to check the *Properties* for the TCP/IP protocol.

Internet Access

Problem 1: When I enter a URL or IP address I get a time out error.

Solution 1: A number of things could be causing this. Try the following troubleshooting steps.

- Check if other PCs work. If they do, ensure that your PCs IP settings are correct. If using a Fixed (Static) IP Address, check the Network Mask, Default gateway and DNS as well as the IP Address.
- If the PCs are configured correctly, but still not working, check the 54Mbps 802.11g ADSL Firewall Modem Router. Ensure that it is connected and ON. Connect to it and check its settings. (If you can't connect to it, check the LAN and power connections.)
- Check the 54Mbps 802.11g ADSL Firewall Modem Router's status

screen to see if it is working correctly.

Problem 2: **Some applications do not run properly when using the 54Mbps 802.11g ADSL Firewall Modem Router.**

Solution 2: The 54Mbps 802.11g ADSL Firewall Modem Router processes the data passing through it, so it is not transparent.

For incoming connections, you must use the Virtual Server or Firewall Rules to specify the PC which will receive the incoming traffic.

You can also use the *DMZ* function. This should work with almost every application, but:

- It is a security risk, since the firewall is disabled.
- Only one (1) PC can use this feature.

Wireless Access

Problem 1: **My PC can't locate the Wireless Access Point.**

Solution 1: Check the following.

- Your PC is set to *Infrastructure Mode*. (Access Points are always in *Infrastructure Mode*)
- The SSID on your PC and the Wireless Access Point are the same. Remember that the SSID is case-sensitive. So, for example "Workgroup" does NOT match "workgroup".
- Both your PC and the 54Mbps 802.11g ADSL Firewall Modem Router must have the same setting for WEP. The default setting for the 54Mbps 802.11g ADSL Firewall Modem Router is disabled, so your wireless station should also have WEP disabled.
- If WEP is enabled on the 54Mbps 802.11g ADSL Firewall Modem Router, your PC must have WEP enabled, and the key must match.
- If the 54Mbps 802.11g ADSL Firewall Modem Router's *Wireless* screen is set to *Allow Trusted PCs only*, then each of your Wireless stations must have been designated as "Trusted", or the Wireless station will be blocked.
- To see if radio interference is causing a problem, see if connection is possible when close to the 54Mbps 802.11g ADSL Firewall Modem Router.
Remember that the connection range can be as little as 100 feet in poor environments.

Problem 2: **Wireless connection speed is very slow.**

Solution 2: The wireless system will connect at the highest possible speed, depending on the distance and the environment. To obtain the highest possible connection speed, you can experiment with the following:

- 54Mbps 802.11g ADSL Firewall Modem Router location.
Try adjusting the location and orientation of the 54Mbps 802.11g ADSL Firewall Modem Router.
- Wireless Channel
If interference is the problem, changing to another channel may show a marked improvement.
- Radio Interference

Other devices may be causing interference. You can experiment by switching other devices Off, and see if this helps. Any "noisy" devices should be shielded or relocated.

- **RF Shielding**
Your environment may tend to block transmission between the wireless stations. This will mean high access speed is only possible when close to the 54Mbps 802.11g ADSL Firewall Modem Router.

Appendix B

About Wireless LANs



This Appendix provides some background information about using Wireless LANs (WLANs).

Modes

Wireless LANs can work in either of two (2) modes:

- Ad-hoc
- Infrastructure

Ad-hoc Mode

Ad-hoc mode does not require an Access Point or a wired (Ethernet) LAN. Wireless Stations (e.g. notebook PCs with wireless cards) communicate directly with each other.

Infrastructure Mode

In Infrastructure Mode, one or more Access Points are used to connect Wireless Stations (e.g. Notebook PCs with wireless cards) to a wired (Ethernet) LAN. The Wireless Stations can then access all LAN resources.



Access Points can only function in "Infrastructure" mode, and can communicate only with Wireless Stations which are set to "Infrastructure" mode.

BSS/ESS

BSS

A group of Wireless Stations and a single Access Point, all using the same ID (SSID), form a Basic Service Set (BSS).

Using the same SSID is essential. Devices with different SSIDs are unable to communicate with each other.

ESS

A group of Wireless Stations, and multiple Access Points, all using the same ID (ESSID), form an Extended Service Set (ESS).

Different Access Points within an ESS can use different Channels. In fact, to reduce interference, it is recommended that adjacent Access Points **SHOULD** use different channels.

As Wireless Stations are physically moved through the area covered by an ESS, they will automatically change to the Access Point which has the least interference or best performance. This capability is called **Roaming**. (Access Points do not have or require Roaming capabilities.)

Channels

The Wireless Channel sets the radio frequency used for communication.

- Access Points use a fixed Channel. You can select the Channel used. This allows you to choose a Channel which provides the least interference and best performance. In the USA and Canada, 11 channels are available. If using multiple Access Points, it is better if adjacent Access Points use different Channels to reduce interference.
- In "Infrastructure" mode, Wireless Stations normally scan all Channels, looking for an Access Point. If more than one Access Point can be used, the one with the strongest signal is used. (This can only happen within an ESS.)
- If using "Ad-hoc" mode (no Access Point), all Wireless stations should be set to use the same Channel. However, most Wireless stations will still scan all Channels to see if there is an existing "Ad-hoc" group they can join.

WEP

WEP (Wired Equivalent Privacy) is a standard for encrypting data before it is transmitted.

This is desirable because it is impossible to prevent snoopers from receiving any data which is transmitted by your Wireless Stations. But if the data is encrypted, then it is meaningless unless the receiver can decrypt it.

If WEP is used, the Wireless Stations and the Access Point must have the same settings for each of the following:

WEP	Off, 64 Bit, 128 Bit
Key	For 64 Bit encryption, the Key value must match. For 128 Bit encryption, the Key value must match
WEP Authentication	Open System or Shared Key.

WPA-PSK

WPA-PSK is another standard for encrypting data before it is transmitted. This is a later standard than WEP (Wired Equivalent Privacy), and provides greater security for your data. Data is encrypted using a 256Bit key which is automatically generated and changed often.

If all your Wireless stations support WPA-PSK, you should use this instead of WEP.

If WPA-PSK is used, the Wireless Stations and the Access Point must have the same settings for each of the following:

WPA PSK (Pre-shared Key)	Enter the same value on every station and the AP. The PSK must be from 8 to 63 characters in length. The 256Bit key used for the actual encryption is derived from this key.
Encryption	The same encryption method must be used. The most common encryption method is TKIP. Another widely-supported method is AES.

Wireless LAN Configuration

To allow Wireless Stations to use the Access Point, the Wireless Stations and the Access Point must use the same settings, as follows:

Mode	On client Wireless Stations, the mode must be set to "Infrastructure". (The Access Point is always in "Infrastructure" mode.)
SSID (ESSID)	Wireless Stations should use the same SSID (ESSID) as the Access Point they wish to connect to. Alternatively, the SSID can be set to "any" or null (blank) to allow connection to any Access Point.
Wireless Security	<p>The Wireless Stations and the Access Point must use the same settings for Wireless security. (None, WEP, WPA-PSK).</p> <p>WEP: If WEP is used, the Key size (64Bit, 128Bit), Key value, and Authentication settings must be the same on the Wireless Stations and the Access Point.</p> <p>WPA-PSK: If WPA-PSK is used, all Wireless Stations must be set to use WPA-PSK, and have the same Pre-shared Key and encryption system.</p> <p>For Ad-hoc networks (no Access Point), all Wireless stations must use the same security settings.</p>

Appendix C

Specifications



Multi-Function Wireless ADSL/Modem Router

Model	54Mbps 802.11g ADSL Firewall Modem Router
ADSL Interface	T1.413, G.DMT, G.lite, multi-mode
Dimensions	175mm (W) * 122mm 114mm(D) * 30 33mm mm(H)
Operating Temperature	0° C to 40° C
Storage Temperature	-10° C to 70° C
Network Protocol:	TCP/IP
Network Interface:	4 * 10/100BaseT (RJ45) LAN connection 1 * RJ11 for ADSL line
LEDs	13
Power Adapter	12VDC DC 1A External

Wireless Interface

Standards	IEEE802.11b, IEEE802.11g WLAN, 802.11G-plus (Texas Instruments proprietary enhanced mode) JEIDA 4.2, roaming support
Frequency	2.4 to 2.4835GHz (Industrial Scientific Medical Band)
Channels	Maximum 14 Channels, depending on regulatory authorities
Modulation	CCK, DQPSK, DBPSK, OFDM/CCK
Data Rate	Up to 54 Mbps (802.11g)
Coverage Area	Indoors : 15m @54Mbps, 120m @6Mbps or lower Outdoors : 40m @54Mbps, 300m @6Mbps or lower
Security	WEP 64Bit, 128Bit, WPA-PSK, MAC address checking
Output Power	13dBm (typical)
Receiver Sensitivity	-80dBm Min.

Regulatory Approvals

FCC Statement

This equipment has been tested and found to comply with the limits for a Class B digital device, pursuant to Part 15 of the FCC Rules. These limits are designed to provide reasonable protection against harmful interference in a residential installation.

This equipment generates, uses and can radiate radio frequency energy and, if not installed and used in accordance with the instructions, may cause harmful interference to radio communications. However, there is no guarantee that interference will not occur in a particular installation. If this equipment does cause harmful interference to radio or television reception, which can be determined by turning the equipment off and on, the user is encouraged to try to correct the interference by one of the following measures:

- Reorient or relocate the receiving antenna.
- Increase the separation between the equipment and receiver.
- Connect the equipment into an outlet on a circuit different from that to which the receiver is connected.
- Consult the dealer or an experienced radio/TV technician for help.

To assure continued compliance, any changes or modifications not expressly approved by the party responsible for compliance could void the user's authority to operate this equipment. (Example - use only shielded interface cables when connecting to computer or peripheral devices).

FCC Radiation Exposure Statement

This equipment complies with FCC RF radiation exposure limits set forth for an uncontrolled environment. This equipment should be installed and operated with a minimum distance of 20 centimeters between the radiator and your body.

This device complies with Part 15 of the FCC Rules. Operation is subject to the following two conditions:

- (1) This device may not cause harmful interference, and
- (2) This device must accept any interference received, including interference that may cause undesired operation.

This transmitter must not be co-located or operating in conjunction with any other antenna or transmitter.

CE Approval

CE Standards

This product complies with the 99/5/EEC directives, including the following safety and EMC standards:

- EN300328-2
- EN301489-1/-17
- EN60950

CE Marking Warning

This is a Class B product. In a domestic environment this product may cause radio interference in which case the user may be required to take adequate measures.

Limited Warranty

TRENDnet warrants its products against defects in material and workmanship, under normal use and service, for the following lengths of time from the date of purchase.

TEW-435BRM

Three years

If a product does not operate as warranted above during the applicable warranty period, TRENDnet shall, at its option and expense, repair the defective product or deliver to customer an equivalent product to replace the defective item. All products that are replaced will become the property of TRENDnet. Replacement products may be new or reconditioned.

TRENDnet shall not be responsible for any software, firmware, information, or memory data of customer contained in, stored on, or integrated with any products returned to TRENDnet pursuant to any warranty.

There are no user serviceable parts inside the product. Do not remove or attempt to service the product through any unauthorized service center. This warranty is voided if (i) the product has been modified or repaired by any unauthorized service center, (ii) the product was subject to accident, abuse, or improper use (iii) the product was subject to conditions more severe than those specified in the manual.

Warranty service may be obtained by contacting TRENDnet office within the applicable warranty period for a Return Material Authorization (RMA) number, accompanied by a copy of the dated proof of the purchase. Products returned to TRENDnet must be pre-authorized by TRENDnet with RMA number marked on the outside of the package, and sent prepaid, insured and packaged appropriately for safe shipment.

WARRANTIES EXCLUSIVE: IF THE TRENDNET PRODUCT DOES NOT OPERATE AS WARRANTED ABOVE, THE CUSTOMER'S SOLE REMEDY SHALL BE, AT TRENDNET'S OPTION, REPAIR OR REPLACEMENT. THE FOREGOING WARRANTIES AND REMEDIES ARE EXCLUSIVE AND ARE IN LIEU OF ALL OTHER WARRANTIES, EXPRESSED OR IMPLIED, EITHER IN FACT OR BY OPERATION OF LAW, STATUTORY OR OTHERWISE, INCLUDING WARRANTIES OF MERCHANTABILITY AND FITNESS FOR A PARTICULAR PURPOSE. TRENDNET NEITHER ASSUMES NOR AUTHORIZES ANY OTHER PERSON TO ASSUME FOR IT ANY OTHER LIABILITY IN CONNECTION WITH THE SALE, INSTALLATION, MAINTENANCE OR USE OF TRENDNET'S PRODUCTS.

TRENDNET SHALL NOT BE LIABLE UNDER THIS WARRANTY IF ITS TESTING AND EXAMINATION DISCLOSE THAT THE ALLEGED DEFECT IN THE PRODUCT DOES NOT EXIST OR WAS CAUSED BY CUSTOMER'S OR ANY THIRD PERSON'S MISUSE, NEGLIGENCE, IMPROPER INSTALLATION OR TESTING, UNAUTHORIZED ATTEMPTS TO REPAIR OR MODIFY, OR ANY OTHER CAUSE BEYOND THE RANGE OF THE INTENDED USE, OR BY ACCIDENT, FIRE, LIGHTNING, OR OTHER HAZARD.

LIMITATION OF LIABILITY: TO THE FULL EXTENT ALLOWED BY LAW TRENDNET ALSO EXCLUDES FOR ITSELF AND ITS SUPPLIERS ANY LIABILITY, WHETHER BASED IN CONTRACT OR TORT (INCLUDING NEGLIGENCE), FOR INCIDENTAL, CONSEQUENTIAL, INDIRECT, SPECIAL, OR PUNITIVE DAMAGES OF ANY KIND, OR FOR LOSS OF REVENUE OR PROFITS, LOSS OF BUSINESS, LOSS OF INFORMATION OR DATE, OR OTHER FINANCIAL LOSS ARISING OUT OF OR IN CONNECTION WITH THE SALE, INSTALLATION, MAINTENANCE, USE, PERFORMANCE, FAILURE, OR INTERRUPTION OF THE POSSIBILITY OF SUCH DAMAGES, AND LIMITS ITS LIABILITY TO REPAIR, REPLACEMENT, OR REFUND OF THE PURCHASE PRICE PAID, AT TRENDNET'S OPTION. THIS DISCLAIMER OF LIABILITY FOR DAMAGES WILL NOT BE AFFECTED IF ANY REMEDY PROVIDED HEREIN SHALL FAIL OF ITS ESSENTIAL PURPOSE.

Governing Law: This Limited Warranty shall be governed by the laws of the state of California.

Note: AC/DC Power Adapter, Cooling Fan, and Power Supply carry 1-Year Warranty



TRENDnet Technical Support

US • Canada

Toll Free Telephone: 1(866) 845-3673

24/7 Tech Support



Europe (Germany • France • Italy • Spain • Switzerland • UK)

Toll Free Telephone: +00800 60 76 76 67

English/Espanol - 24/7

Francais/Deutsch - 11am-8pm, Monday - Friday MET

Worldwide

Telephone: +(31) (0) 20 504 05 35

English/Espanol - 24/7

Francais/Deutsch - 11am-8pm, Monday - Friday MET

Product Warranty Registration

Please take a moment to register your product online.

Go to TRENDnet's website at <http://www.trendnet.com>

TRENDnet

3135 Kashiwa Street

Torrance, CA 90505

USA