

TRENDnet®



Quick Installation Guide

Web Smart Switch Series

Table of Contents

1 Deutsch

1. Bevor Sie anfangen
2. Schnellübersicht
3. Hardware-Installation und Konfiguration

1. Bevor Sie anfangen

Packungsinhalt

- Anleitung zur Schnellinstallation
- Stromkabel (1,8 m / 6 Fuß)
- Montagesatz für Gestell

Installationsanforderungen

- Einen Computer mit einem Ethernet-Anschluss und Web-Browser
- Netzwerkkabel

Optionale Geräte

- Standardmäßiges 19"-Gestell
- SFP-Modul (z.B. TE100-MGBFX, TEG-MGBSX, TEG-MGBS10, TEG-MGBS40, TEG-MGBS80, TEG-MGBS10D3, TEG-MGBS10D5, TEG-MGBS40D3, TEG-MGBS40D5)

2. Schnellübersicht

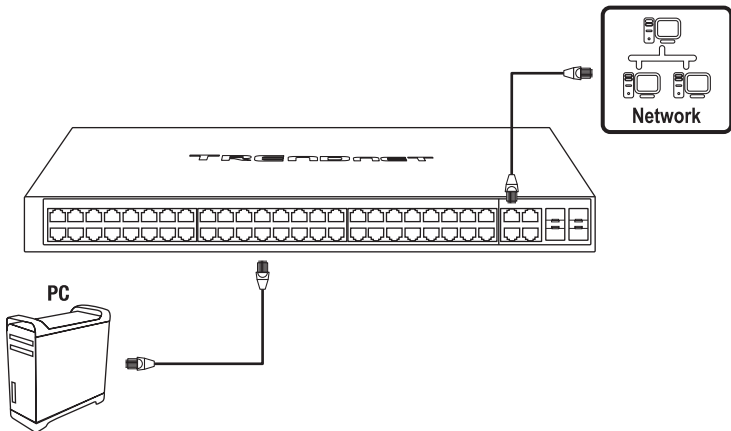

Hinweis: Das Switchmodell kann sich von dem im folgenden Beispiel gezeigten unterscheiden.

3. Hardware-Installation und Konfiguration

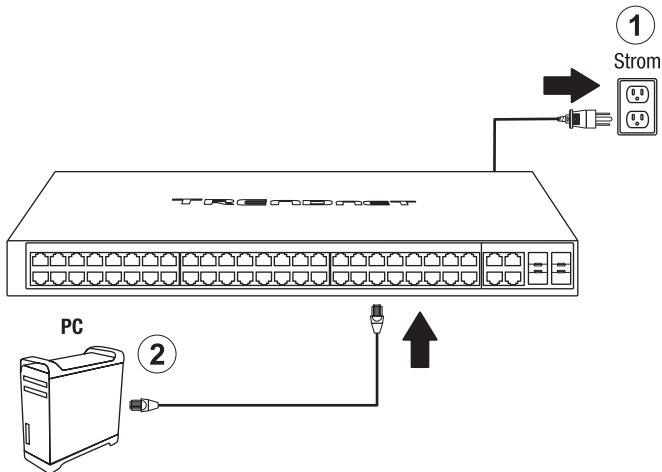

3. Weisen Sie dem Netzwerkadapter Ihres Computers eine statische IP-Adresse im Subnetz 192.168.10.x (z.B. 192.168.10.25) und die Subnetzmaske 255.255.255.0 zu.
4. Öffnen Sie Ihren Webbrowser, geben Sie die IP-Adresse des Switch in die Adressleiste ein und drücken Sie auf die **Eingabetaste**. Die Standard-IP-Adresse lautet 192.168.10.200.

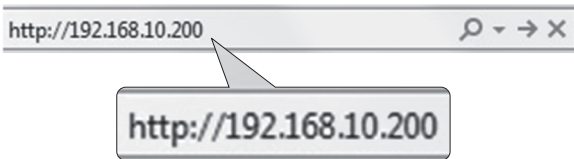

5. Geben Sie **User name** (Benutzername) und **Password** (Kennwort) ein und klicken sie auf **LOGIN**. StandardEinstellung:

User name (Benutzername): **admin**

Password (Kennwort): **admin**

Hinweis: Achten Sie auf Groß- und Kleinschreibung.

The image shows a login form with two input fields. The first field is labeled 'User Name:' and contains the text 'admin'. The second field is labeled 'Password:' and contains six dots. Below the fields is a 'LOGIN' button. Callout boxes point to the 'admin' text in both fields and the 'LOGIN' button.

6. Klicken Sie auf **System** und klicken Sie danach auf **IPv4 Setup**.

7. Konfigurieren Sie den Switch entsprechend den Anforderungen Ihres Netzwerks. Klicken Sie auf **Apply** (Übernehmen).

The image shows a configuration page with a sidebar on the left and a main content area on the right. The sidebar has a 'System' menu item selected, with a sub-menu 'IPv4 Setup' also highlighted. The main content area is titled 'IPv4 Setup' and contains several fields: 'System MAC Address' (00:01:02:03:04:05), 'System IP Address' (192 . 168 . 10 . 206), 'System Subnet Mask' (255 . 255 . 255 . 0), 'System Default Gateway' (0 . 0 . 0 . 0), and 'System IP Mode' (Static). An 'Apply' button is at the bottom. Callout boxes point to the 'System' menu item, the 'IPv4 Setup' sub-menu item, and the 'Apply' button.

8. Klicken Sie auf **OK**.

The image shows a warning dialog box with a title bar that says 'WARNING'. Inside the box, there is a warning icon (a triangle with an exclamation mark) and the text: 'The management session will be disconnected. Use new IP address to connect to device.' Below the text are two buttons: 'OK' and 'Cancel'. A callout box points to the 'OK' button.

9. Klicken Sie links auf **Tools**, klicken Sie danach auf **Konfiguration** und klicken Sie dann auf **Speichern**.

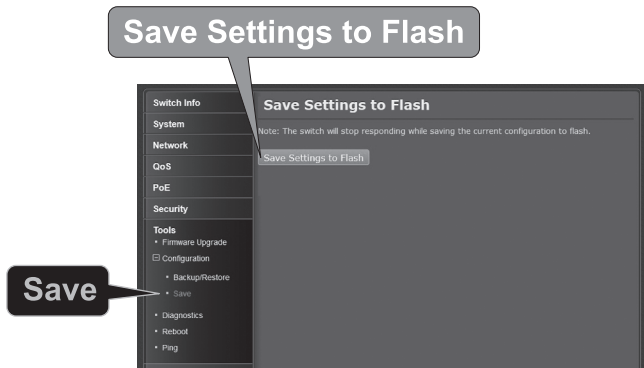

10. Klicken Sie auf **OK**.

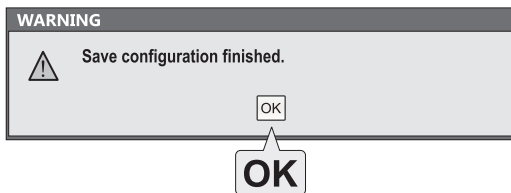

Hinweis:

1. Installieren Sie das Webmanagement-Programm, wenn Sie problemlos alle webbasierten Switches Ihres Netzwerks auffinden, IP-Adressen zuweisen, Kennwörter ändern und die Firmware aktualisieren wollen. Gehen Sie dazu entsprechend den folgenden Schritten vor.
2. Um die neueste Version des Benutzerhandbuchs herunterzuladen, gehen Sie bitte zu: <http://www.trendnet.com/support> und wählen Sie **Switch Model** in der Dropdown-Liste Produkt-Download.

UL Warning

- 1) Elevated Operating Ambient Temperature - If installed in a closed or multi-unit rack assembly, the operating ambient temperature of the rack environment may be greater than room ambient. Therefore, consideration should be given to installing the equipment in an environment compatible with the manufacturer's maximum rated ambient temperature (Tmra).
- 2) Reduced Air Flow - Installation of the equipment in a rack should be such that the amount of air flow required for safe operation of the equipment is not compromised.
- 3) Mechanical Loading - Mounting of the equipment in the rack should be such that a hazardous condition is not achieved due to uneven mechanical loading.
- 4) Circuit Overloading - Consideration should be given to the connection of the equipment to the supply circuit and the effect that overloading of circuits might have on over current protection and supply wiring. Appropriate consideration of equipment nameplate ratings should be used when addressing this concern.
- 5) Reliable Earthing - Reliable earthing of rack-mounted equipment should be maintained. Particular attention should be given to supply connections other than direct connections to the branch circuit (e.g., use of power strips).

Rack Installation

The Switch can be mounted in an EIA standard, 19-inch rack, which can be placed in a wiring closet with other equipment. To install, attach the mounting brackets on the switch's front panel (one on each side) and secure them with the screws provided.

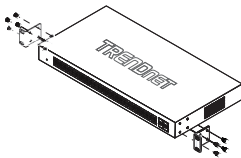

Attaching the mounting brackets to the Switch

Use the screws provided with the equipment rack to mount the Switch on the rack.

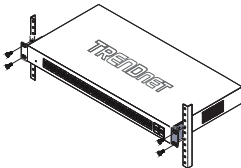

Installing the Switch in an equipment rack

TRENDNET[®]

Certifications

This device complies with Part 15 of the FCC Rules.

Operation is subject to the following two conditions:

- (1) This device may not cause harmful interference.
- (2) This device must accept any interference received.

Including interference that may cause undesired operation.



Waste electrical and electronic products must not be disposed of with household waste. Please recycle where facilities exist. Check with your Local Authority or Retailer for recycling advice.

Fiber product warning note:

If the Optical Transceiver doesn't ship with the unit, the user manual shall have the description as below or equivalent:

"This product is intended to be used with a UL Listed Optical Transceiver product, Rated DC3.3V, Laser Class I."

Laser warning note:

This product is intended to be used with a UL Listed Optical Transceiver product, Rated DC3.3V, Laser Class I.

Technical Support

If you have any questions regarding the product installation, please contact our Technical Support.

Toll free US/Canada: **1-855-373-4741**

Regional phone numbers available at www.trendnet.com/support

TRENDnet

20675 Manhattan Place
Torrance, CA 90501
USA

Applies to PoE Products Only: This product is to be connected only to PoE networks without routing to the outside plant.

Note

The Manufacturer is not responsible for any radio or TV interference caused by unauthorized modifications to this equipment. Such modifications could void the user's authority to operate the equipment.

Advertencia

En todos nuestros equipos se mencionan claramente las características del adaptador de alimentación necesario para su funcionamiento. El uso de un adaptador distinto al mencionado puede producir daños físicos y/o daños al equipo conectado. El adaptador de alimentación debe operar con voltaje y frecuencia de la energía eléctrica domiciliar existente en el país o zona de instalación.

Product Warranty Registration

Please take a moment to register your product online. Go to TRENDnet's website at www.trendnet.com/register