

Compact Flash Size

10/100 Fast Ethernet

LAN Card

**For Both Notebook PC and
Windows CE-based PDA / Palm PC**

Users Guide

FCC REGULATORY STATEMENTS

Part15, Class B

This device complies with Part 15 of FCC rules.

Operation is subject to the following two conditions:

1. This device may not cause harmful interface, and
2. This device must accept any interface received, including interface that may cause undesired operation. This equipment has been tested and found to comply with the limits for a Class B digital device, pursuant to Part 15 of the FCC Rules. These limits are designed to provide reasonable protection against harmful interference in a residential installation. This equipment generates, uses and can radiate radio frequency energy, and if not installed and used in accordance with the instructions, may cause harmful interference to radio communications. However, there is no guarantee that interference will not occur in a particular installation. If this equipment does cause harmful interference to radio or television reception, which can be determined by turning off and on, the user is encouraged to try to correct the interference by one or more of the following measures:
 - Reorient or relocate the receiving antenna.
 - Increase the distance between the equipment and receiver.
 - Connect the equipment into an outlet on a circuit different from that to which the receiver is connected.



Changes or modifications not expressly approved by party responsible for compliance could void the user the user authority to operate the equipment.

Table of Contents

Introduction	1
SYSTEM REQUIREMENTS.....	1
OPERATING ENVIRONMENTS	2
Parts Names	3
HARDWARE INSTALLATION	4
Connecting to a PDA/Palm PC.....	4
Installing into a Notebook PC	4
Connecting to the Network.....	5
SOFTWARE INSTALLATION For	
PDA/Palm PC with Windows CE 2.0.....	6
SOFTWARE INSTALLATION For	
Notebook PC	8
Installation for Windows 95	8
Installation for Windows 98	8
Installation for Window ME.....	11
Installation for Windows 2000	12
Installation for Windows XP	15
Installation for Windows NT 4.0.....	17
Novell Netware 3.x/4.x.....	19
MS LAN Manager.....	23
Packet Driver	25
Windows for Workgroups 3.11	26

Installation for IBM OS/2 Warp	31
INTERNET ACCESS	33
Setup Pocket PC 2002 PDA	33
Appendix A. SPECIFICATIONS	39
Network Interface Specifications	39
Host Interface and Physical Specifications..	39
Operating Systems	40
Power Requirements.....	40
General Specification	40

INTRODUCTION

This CompactFlash Size 10/100 Fast Ethernet LAN Card is designed for Windows CE-based palm-sized PCs, handheld PCs and any computer with a CompactFlash slot.

Plus, with connecting to a PCMCIA Adapter (**not included**), this CompactFlash Fast Ethernet LAN Card turns into a PC card that plugs into any computer with a PCMCIA slot.

The CompactFlash Fast Ethernet LAN Card is simple to use, providing automatic installation, and no external power is required.

SYSTEM REQUIREMENTS

For Notebook PC:

- An IBM compatible notebook computer with 386SX or faster processor
- At least one Type II PC Card socket
- Drivers and utilities provided with this product
- PCMCIA release 2.1 compliant Card Services and Socket Services.

For Windows CE-based PDA/Palm PC:

- One Type I CompactFlash Slot supporting IO functionality.
- Windows CE 2.0 or newer version
- Windows CE Service Disk
- CF+ and CompactFlash Spec. Reversion 1.4

compliant Card Services and Socket Services

OPERATING ENVIRONMENTS

For Notebook PC:

Novell Netware 3.x/4.x

Microsoft LAN Manager

Packet Driver Applications

Microsoft Windows for Workgroups 3.11

Microsoft Windows 3.1

Microsoft Windows NT 4.0

Windows 98

Windows 2000

Windows ME

Windows XP

Lantastic 6.0

IBM OS/2 Warp Version 3

For Windows CE-based PDA/Palm PC:

Software Compatibility

Windows CE 2.0 or newer version

Hardware Compatibility for Processor Families:

Supports PDA/Palm PC using MIPS4000 series, and Hitachi Sh3 series processors.

Parts Names

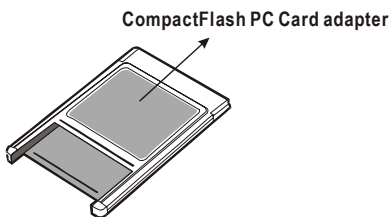
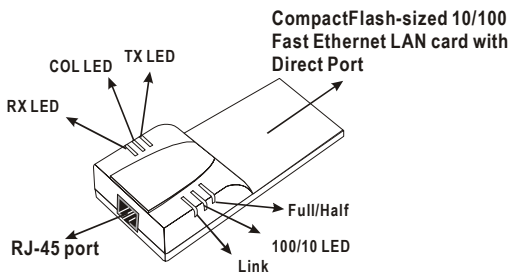

HARDWARE INSTALLATION

It's referred to as the **Compact Card** for the separate CompactFlash Size 10/100 Fast Ethernet LAN Card; and referred to as the **PC Card** for the CompactFlash Fast Ethernet LAN Card together with our CompactFlash PC Card Adapter in this manual.

Connecting to a PDA/Palm PC

1. Insert the CompactFlash Size 10/100 Fast Ethernet LAN Card into Windows CE-based PDA/Palm PC by aligning the Compact Card with wide connector toward the CompactFlash slot.

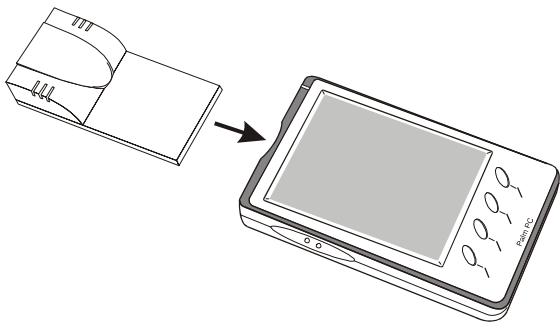

Installing into a Notebook PC

1. Plug the CompactFlash-Size 10/100 Fast Ethernet LAN Card into the PCMCIA Adapter. The CompactFlash Fast Ethernet LAN Card is then turning into a conventional PCMCIA type II PC Card.

2. Align the PC Card toward the PC Card slot with brand label facing upward, as shown below.

Notebook

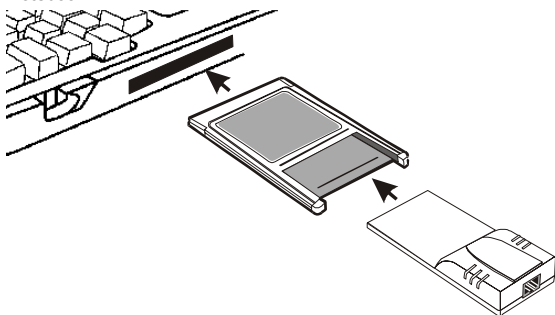

Connecting to the Network

1. Connect unshielded twisted pair (UTP) cable to the RJ-45 connector before loading any network driver.
- For operation in the 10Mbps (10Base-T) Ethernet network, Category 3, 4 or 5 unshielded twisted pair (UTP) cable could be used to connect between the media coupler and a 10Mbps hub or switch.

SOFTWARE INSTALLATION FOR PDA/PALM PC WITH WINDOWS CE 2.0

1. Establish a connection between the PDA/Palm PC with the Host PC, typically your Host PC running Windows98/2000/ME/XP/NT4.0.
2. Install "ActiveSync" connection from the WinCE Services CD to your desktop PC. For more information, please refer to Online help.
3. Connect the PDA/Palm PC to the Host PC COM1 or COM2 port with serial cable.
4. Once the connection between Host PC and PDA/Palm PC is established, an "Mobile device" icon will appear inside "My Computer" folder of the Host PC.
5. Insert Disk " CompactFlash Ethernet LAN Card for WinCE". Use "Windows Explorer" to open files directories in A:, then double click on the directory A: disk and look for setup file "setup.exe". Please Execute the setup file.
6. Insert the Compact Card and reset the PDA/Palm PC thereafter. Then Configure your Compact LAN Card as follows.
7. Double click on "Network", select "property and choose "Obtain an IP address through DHCP server". At this time, you should see "*CompactFlash Size 10/100 Fast Ethernet LAN Card*" installed and shown in the WinCE screen.

- 8.If your local LAN does not have the DHCP, you may have to manually configure the IP address under “Specific an IP address” option.
- 9.After you have followed the procedure described above and setup the Compact Card correctly, you may use the pocket Internet Explore to browse the internet.

Note: Host PC's running Windows 95 OSR2 cannot active sync after entering suspend mode. If the machine goes into suspend, it will need to be reset in order to active sync with the handheld device.

SOFTWARE INSTALLATION FOR NOTEBOOK PC

Installation for Windows 95

The installation procedures for the network driver may vary slightly depending on the version of Windows 95 you are using and also your current system configuration.

1. Once the **PCMCIA Fast Ethernet PC Card** is connected to your computer, Windows 95 will automatically detect the new hardware device as shown below. Insert the program diskette #1 into your floppy drive.
2. Click **Next**. When the **PCMCIA Fast Ethernet PC Card** message appears, click **Finish**. The Installation program will continue to copy the necessary files into your computer.
3. Follow the on-screen instruction to proceed. If Windows asks you to supply your original Windows 95 installation or setup files, insert the CD-ROM or disks as requested, and direct Windows 95 to the proper location.
4. When asked if you want to restart your computer, click **Yes**.

Installation for Windows 98

1. Once the **PC Card** is connected to your computer, Windows 98 will automatically detect the new hardware device as shown below. Click **Next**.



2. Insert the device driver diskette into your floppy drive. When Windows prompts you **What do you want Windows to do?** Select **Search for the best driver for your device. (Recommended)**. Click **Next**.



3. Follow the on-screen instruction to proceed.



4. The installation program will proceed automatically.
5. In the following dialog box, direct your system to copy the requested files from the floppy root directory, i.e. A:\. Press OK.

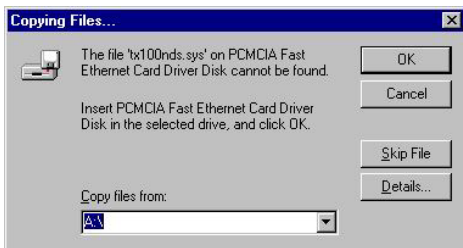

6. If you are asked to insert Windows 98 CD-ROM in the selective drive, please do so to have Windows copy all the necessary files to your system. . When the following window appears, click **Finish**.



7. Click **Yes** to restart your computer.

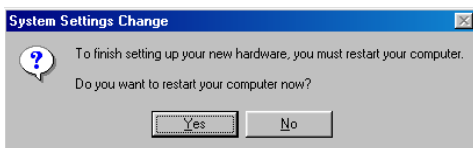

Installation for Window ME

1. Once the PC Card is well connected to your computer, Windows ME will automatically detect the new device. Select **Specify the Location of the driver...** and click **Next**.



2. Insert the device driver disk into the floppy disk drive on your system.
3. Windows will copy the appropriate driver to your system. If Windows ME asks you to supply your original Windows ME installation CD-ROM, load it on the CD-ROM drive. Click **Finish** to complete the software installation.



4. Reboot your computer to activate the new device.

Installation for Windows 2000

1. Insert the PC Card into the slot. When the **FOUND NEW HARDWARE WIZARD** dialog box appears, press **Next**.



2. When Windows prompt you a **FOUND NEW HARDWARE WIZARD** dialog box, select **Search for the ...** and press **Next**.



3. Windows will prompt an **FOUND NEW HARDWARE WIZARD** dialog box. In this time, select **Floppy disk drives** and insert the driver diskette. Press **Next**. When asked

for the original Windows 2000 CD/disks please follow the on-screen instruction.

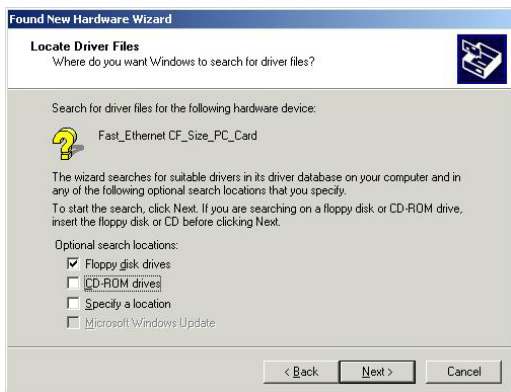

4. Wait for a while until Windows has found the appropriate driver.
5. Click **Yes** to continue.

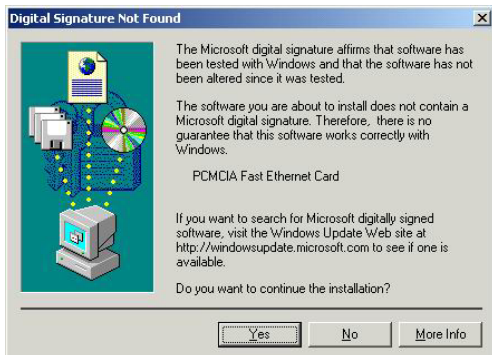

6. Click **Finish**. The PC Card driver installation is successfully completed.



7. For the first time installation, click **Network icon in Control Panel** to add **Protocols, Client and Service** if needed.
8. Reboot your computer to activate the new device.

Installation for Windows XP

1. Once the device is well connected, Windows will detect the new device and prompt you to insert the network device driver. Insert the device **Driver Disk** into the floppy disk drive of your system. Click **Install the software automatically (Recommended)** and click **Next**.

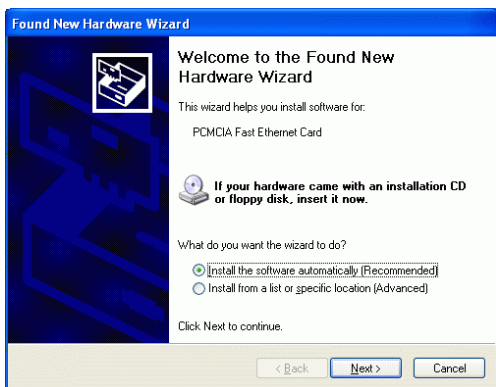

2. Windows will start searching for the appropriate driver for this hardware. Select any drivers named as **PCMCIA Fast Ethernet Card**, and click **Next**.

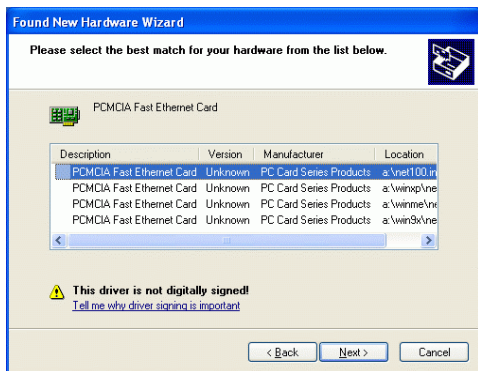

3. Windows will start searching for the appropriate driver for the installation. When the screen appears as below, click **Continue Anyway** to proceed.



4. Wait while Windows copies the appropriate driver to your system.
5. Click **Finish**. The software installation for this network device is now completed.



Installation for Windows NT 4.0

This section describes the installation for Windows NT under the condition that Windows

NT is already installed in your computer. If your computer is not yet networking installed, refer to the Windows documentation for details. Also remember to have your original Windows NT CD-ROM handy before you begin the installation. For Windows NT may ask for it during the installation.

1. Before you turn on your computer, make sure the **PCMCIA Fast Ethernet PC Card** has been properly inserted into the free PCMCIA slot of your computer.
2. Start Windows NT.
3. Click **Start→Settings→Control Panel**. Double-click on the **Network** icon.
4. When the Network window appears, click on the **Adapters** tab. Click on the **Add** button, followed by **Have Disk**. Put the driver disk into drive A.
5. When asked to supply the path to the disk, type a:\ and click **OK**.
6. Windows NT will ask you to supply the I/O Base, Interrupt, and Memory values for the card. Good values to start with are 300 (for the I/O Base) and 5 (for the IRQ).
7. When you're finished, click **OK**. Windows NT will copy necessary files to your computer.
8. When the Network window reappears, click on the **Bindings** tab. Choose your bindings. Click on the Protocols tab and select your settings. Do the same for the **Services** tab.

9. After your **bindings**, **settings**, and **services** are set, click on the **Close** button. Choose to restart your computer. After Windows NT restarts, be sure to log in.

Insert the driver diskette into the floppy drive and set the current drive to the floppy drive. Then run *INSTALL* to install the real mode drivers such as ODI or NDIS 2.x or Packet Drivers into the target disk.

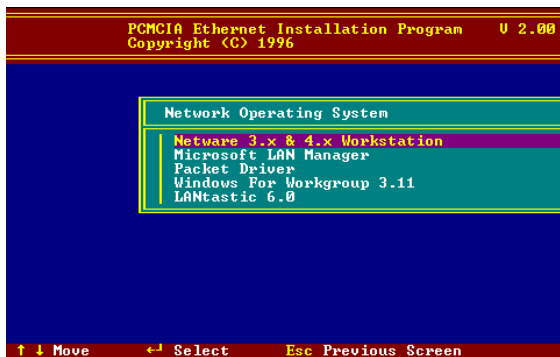

Novell Netware 3.x/4.x

Installation for ODI DRIVER

Automatic (Menu) Installation

1. Run *INSTALL.EXE* from the root directory of driver diskette.
2. Select *Netware 3.x and 4.x Workstation* item from menu.
3. If current settings are good, select *Start Installation* and the program will continue automatically, skip to step 5. Otherwise,

select **Modify Parameters** to make settings changed.

4. Move the cursor to select the setting you want to make change and press <Enter> to select a fit value. When the configurations are set completely, press <Enter> on the **OK** field to exit the screen and go back to step 3.
5. Installation program starts copying related files from diskette to the destination directory and modifies AUTOEXEC.BAT and NET.CFG under user's agreement
6. When completed. Remember to reboot the computer to make your Netware connection.

Manual Installation

1. Copy the files LE100ODI.COM and NET.CFG from the path \NETWARE and the file LANEN.EXE from the path \ENABLER in the driver diskette into the Netware client directory containing Novell's LSL.COM, IPXODI.COM and NETx.COM files.
2. Use a text editor to edit the NET.CFG for setting the default frame type. In the Netware server the frame type is set to 802.3 for NW3.11 and 802.2 for NW3.12 and NW4.x . The frame type must be set as same as the server, otherwise the client won't be able to login to the server.
3. Follow Novell's instructions on using ODI programs. You can substitute the LE100ODI.COM whenever a reference is made to the **Hardware Specific Module**.

4. A typical ODI workstation startup batch file includes:
- >LANEN //IRQ=dd //IOP=xxx Card Enabler
 - >LSL ; Link Support Layer Module provided by Novell
 - >LE100ODI ; Hardware Specific Module
 - >IPXODI ; IPX Protocol Stack Module provided by Novell
 - >NETx ; Shell Support Module provided by Novell
 - >LOGIN

Novell Client Installation

1. Run the NetWare Client Install V1.21:
 - Get the 4 Client disks from the network administrator, or
 - Run the \NWCLIENT\INSTALL.EXE in a previous Installation
2. A message appears on the screen asking you if you want the program to perform modifications on your AUTOEXEC.BAT and CONFIG.SYS files. Answer "Yes". The program then modifies your AUTOEXEC.BAT and CONFIG.SYS files accordingly and creates backup copies.
3. When the following message appears "Install support for MS Windows? (Y/N)", answer accordingly and provide a path if necessary.
4. When the program displays the following as "Configure your workstation for backup by a NetWare server running software such as BACKUP?"

(Y/N):”, answer accordingly and provide a path if necessary.

5. Select a driver for your network board.
6. From the driver list, select **Other Drivers**.
7. Go to the Insert the Driver Disk dialog box and specify the path where the ODI driver and INS files reside. For example: C:\ODI.DOS.
8. Press **Enter** and select the target ODI driver.
9. Specify the driver's optional settings.
10. Press F10 to save to new configuration.
11. Highlight "**Install press here**" and press <Enter> to install.

The program copies the necessary files for NetWare Client. Continue the installation procedure to completion. Upon completion, a new NET.CFG file will be created in your DOS directory. Typically, this file contains the following lines:

```
Link Driver LE1000DI
#FRAME Ethernet_802.3
FRAME Ethernet_802.2
:
```

12. Copy the file LANEN.EXE from the directory \ENABLER in the driver diskette to Netware Client directory.
13. Edit the STARTNET.BAT by a text editor. Add an running LANDEN command at the

beginning of the file. An STARTNET.BAT for the ODI workstation performs as the following

```
LANEN /IOP=nnn /IRQ=n
```

```
--Card Enabler
```

```
SET NWLANGUAGE=ENGLISH
```

```
--Set NetWare 4.X to English language
```

```
LSL --Link Support Layer Module  
provided by Novell
```

```
LE1000DI --Hardware Specific Module
```

```
IPXODI --IPX Protocol Stack Module  
provided by Novell
```

```
VLM --DOS Support Module provided by  
Novell
```

```
F: --Change to connected device
```

```
LOGIN xxx --Login to file server as  
user xxx
```

14. Run STARTNET to access the Novell network.

MS LAN Manager

1. View the *README.TXT* on the installation diskette in the \NDIS2 directory. Before installing the drivers, make sure that the *Microsoft LAN Manager* has been installed in the target path. The installation program will check and modify the *PROTOCOL.INI* file for LAN Manager.

2. Run *INSTALL.EXE* from root directory of driver diskette.
3. Select *Microsoft LAN Manager* item on the menu screen.
4. If current settings are acceptable, select *Start Installation* and go to step 6. Otherwise, select *Modify Parameters* to make setting changed.
5. Move cursor to the fields you want to make change and press <Enter> to select a fit value. When the configuration are set completely, press <Enter> on the **OK** button to exit the screen and go back to step 4.
6. Installation program starts to copy related files from driver diskette to the destination directory and modifies CONFIG.SYS and PROTOCOL.INI under user' s agreement.
7. Reboot the computer to load driver and start LAN Manager in batch.

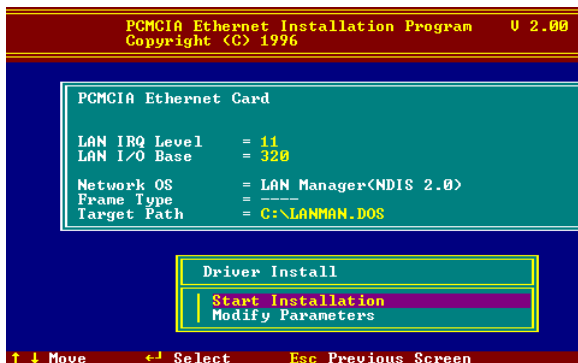

Example of PROTOCOL.INI: used by **LAN Manager**

[PROTMAN]

DRIVERNAME = PROTMAN\$

DYNAMIC = YES

PRIORITY = NETBEUI

[NETBEUI_XIF]

Drivername = netbeui\$

SESSIONS = 6

NCBS = 12

BINDINGS = "LE100NDS_NIF"

LANABASE = 0

[LE100NDS_NIF]

; protocol.ini session for LAN driver.

IOADDRESS = 0x320

INTERRUPT = 11

DRIVERNAME = LE100NDS\$

Packet Driver

1. Run **INSTALL.EXE** from the root directory of the driver diskette.
2. Select **Packet Driver** item on the menu screen.

3. If current settings are acceptable, select **Start Installation** and go to step 5. Otherwise, select **Modify Parameters** to change the settings.
4. Move cursor to the field(s) you want to make changes and press <Enter> to select a fit value. When the configuration are set completely, press <Enter> on the **OK** button to exit the screen and go back to step 3.
5. Installation program starts to copy related files from diskette to the destination directory and modifies AUTOEXEC.BAT under user's agreement.
6. Reboot your computer to load the driver.

Windows for Workgroups 3.11

NDIS3 Driver for Workgroups

1. Run *Windows for Workgroups* and click *Network Setup* in Network group.
2. In Network Settings dialog box, click “**Networks...**” to select the network operating system.
3. In the *Networks* dialog box, select the radio button before **Install Microsoft Windows Network** and *No Additional Network*. Press **OK** to go back to the **Network Settings** screen.
4. Click **Drivers...** button to select network driver.
5. In Network Drivers dialog box, press **Add Adapter...** button to enter the *Add Network*

Adapter dialog box. Select *Unlisted* or *Updated Network Adapter* and press **OK**.

6. Windows will prompt a **Install Driver** dialog box. At this, insert the driver diskette into your floppy drive and press **OK**.
7. Select the **Enhanced mode NDIS3 for...** string and press **OK**.
8. Follow the on-screen instructions to complete the installation and exit Windows
9. Run *INSTALL.EXE* from root directory of driver diskette.
10. Select **Windows for Workgroup** in the Network Operating System screen.
11. If current settings are acceptable, select *Start Installation* and go to step 13. Otherwise, select *Modify Parameters* to make settings changed.
12. Move cursor to the setting(s) you want to make change(s) and press <Enter> to select a fit value. When the configuration is accepted, press <Enter> on the **OK** field to exit the screen and go back to step 11.
13. Select *NDIS Server (LAN Manager,...)* as the network server you will attach to and press <Enter>.
14. Installation program starts to copy related files to the destination directory and modifies AUTOEXEC.BAT and under user's agreement.
15. When finished, remember to reboot your computer to activate the new device.

NDIS2 Driver for Workgroups

1. Run *Windows for Workgroups* and click *Network Setup* icon in Network group.
2. In Network Settings dialog box, click **Networks...** button to select the network operating system.
3. In Networks dialog box, check the radio button before Install *Microsoft Windows Network* and *No Additional Network*. Press **OK** to go back to the Network Settings screen.
4. Click **Drivers...** to select network driver.
5. In the Network Drivers dialog box, press **Add Adapter...** button to enter *Add Network Adapter* dialog box. Select *Unlisted* or *Updated Network Adapter* and press **OK**.
6. Windows will prompt a Install Driver dialog box. In this time, put the driver diskette into floppy drive and press **OK**.
7. Select the **Real mode NDIS2 for....** string and press **OK**.
8. Follow Windows instructions to complete the installation and exit Windows.
9. Run **INSTALL.EXE** from root directory of driver diskette.
10. Select *Windows for Workgroups in Network Operating System* screen.
11. If current settings are acceptable, select *Start Installation* and go to step 13.

Otherwise, select *Modify Parameters* to make settings changed.

12. Move cursor to focus on the setting you want to make a change and press <Enter> to select a fit value. When the configuration is set completely, press <Enter> on the **OK** field to exit the screen and go back to step 11.
13. Select **NDIS Server (LAN Manager,...)** as the network server you will attach to and press <Enter> key.
14. Installation program starts to copy related files to the destination directory and modifies **AUTOEXEC.BAT** under user's agreement.
15. Please reboot the computer to have the driver take effect.

ODI Driver for Workgroups

1. Run *Windows for Workgroups* and click *Network Setup* icon in **Network** group.
2. In *Network Setup* dialog box, click *Networks...* button to select the network operating system.
3. In *Networks* dialog box, check *Install Microsoft Windows Network* and *Others*, thereafter select *Novell NetWare (Workstation Shell, 3.X)* or *Novell NetWare (Workstation 4.0 and above)* and press **OK** to enter the screen of **IPXODI.COM** and **LSL.COM**.

4. Press **OK** to go back the Network Setup screen.
5. Click on *Drivers...* button to select network driver.
6. In *Network Drivers* dialog box, press *Add Adapter...* button to enter *Add Network Adapter* dialog box. Select *Unlisted* or *Updated Network Adapter* and press **OK**.
7. Windows will prompt a *Install Driver* dialog box. In this time, put the driver diskette into floppy drive and press **OK**.
8. Select the *Netware ODI Driver* string and press **OK**.
9. Follow Windows instructions to complete the installation and exit Windows.
10. Run INSTALL.EXE from root directory of driver diskette.
11. Select *Windows for Workgroups* in Network Operating System screen.
12. If current settings are acceptable, select *Start Installation* and go to step 13. Otherwise, select *Modify Parameters* to make settings changed.
13. Move cursor to focus on the setting you want to make a change and press <Enter> to select a fit value. When the configuration is set completely, press <Enter> on the **OK** field to exit the screen and go back to step 11.

14. Select *Novell Netware Server* as the network server you will attach to and press <Enter> key.
15. Installation program starts to copy related files to the destination directory and modifies AUTOEXEC.BAT and NET.CFG under user's agreement.
16. Please reboot the computer to have the driver take effect.

Installation for IBM OS/2 Warp

Before the driver installation, ensure that the PCMCIA Service was installed and worked properly. If the PCMCIA Service of OS/2 Warp has been enabled already, jump to portion B for driver installation; otherwise follow the instructions in the following to install the PCMCIA Service.

Enabling PCMCIA Service of OS/2 Warp

1. In the OS/2 Desktop group, double-click on the *OS/2 System* icon.
2. Double-click on the **System Setup** icon.
3. Double-click on the **Selective Install** icon.
4. Select the **PCMCIA Support** button.
5. Select **PCMCIA** system. For example : select IBM ThinkPad 750
6. Click **OK**”.
7. Click *Install*
8. Select the source drive and directory. For Example D:\OS2IMAGE

9. Click *Install*

10. Click **OK**

Installing NDIS2 driver for IBM LAN Server 4.0

1. In the OS/2 Desktop group, double-click on the *MPTS* icon.
2. Click on the *Configure* button.
3. Select the *LAN adapters and protocols* option.
4. Click on the *Configure* button.
5. Select the *Other adapters ...* option.
6. Insert the driver diskette and type the driver path: A:\OS2\NDIS2. Click **OK**
7. Select *PCMCIA Ethernet Adapter*, and then click on the *Add* button.
8. Select *IBM OS/2 NETBIOS*, and then click on the *Add* button.
9. Click **OK**.
10. Click *Close*.
11. Click *Exit*.
12. Shutdown and restart your system.

INTERNET ACCESS

Setup Pocket PC 2002 PDA

1. Install the driver and network adapter according to the installation guide.
2. Power on PDA.
3. Go to “Start” → “Settings”.
4. Tap “Connections”.
5. Tap “Network Adapters”.

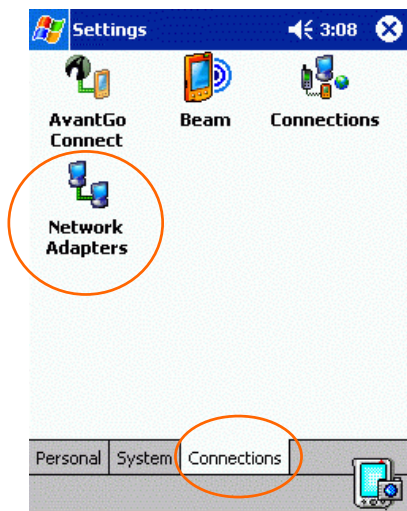

6. Tap “CompactFlash Size 10/100 Fast Ethernet” to highlight it.
7. Tap “Properties”.



8. If you have a DHCP Server on the network, tap the radio button “**Use server-assigned IP address**”.

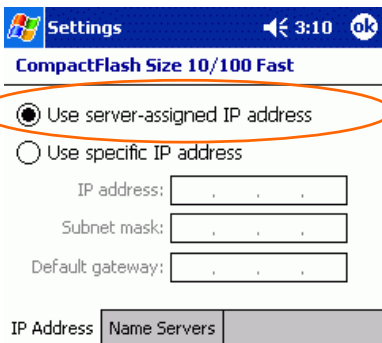

If you need to input fixed IP for the adapter, tap on the radio button “**Use specific IP address**”, key in the IP address, subnet mask, default gateway, tap on “Name Servers”, input the DNS, Alternative DNS, WINS, and

Alternative WINS.

Note: DNS addresses are normally provided by ISP. If you are not using WINS, please leave the filed blank.

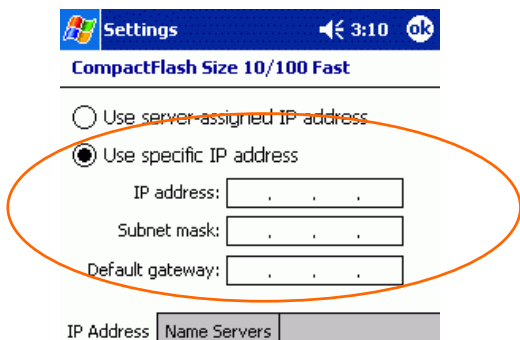

The screenshot shows the Windows XP Network Setup Wizard. The title bar reads "Settings" with a volume icon and "3:10" and an "ok" button. Below the title bar, it says "CompactFlash Size 10/100 Fast". There are two radio button options: "Use server-assigned IP address" (unselected) and "Use specific IP address" (selected). Below the selected option are three input fields: "IP address:", "Subnet mask:", and "Default gateway:", each with a four-dot placeholder. At the bottom, there are three tabs: "IP Address", "Name Servers", and a greyed-out tab.

9. Tap **“Ok”**.

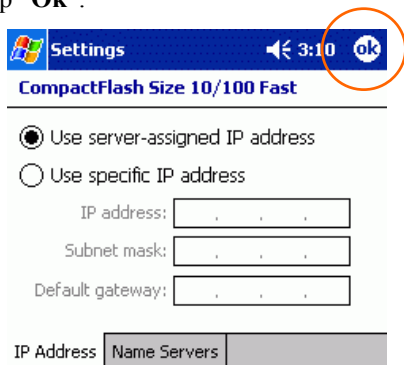

The screenshot shows the same Windows XP Network Setup Wizard. The radio button for "Use server-assigned IP address" is now selected, and the radio button for "Use specific IP address" is unselected. The three input fields for IP address, subnet mask, and default gateway are now greyed out. The "Ok" button in the top right corner is circled in orange. The tabs at the bottom remain the same.

10. Tap **“Ok”** on the pop-up warning screen.

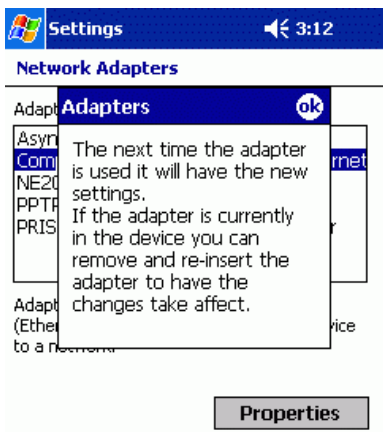

11. Remove the card and reinsert it to the PDA.
12. Go to “**Start**” → “**Settings**”.
13. Tap on “**Connections**”.
14. Tap in “**Connections**”.



15. At the first entry “When needed, automatically connect to the Internet using these settings:”, click on the dropdown menu and select “**My connection**”, and tap on “**Modify**” below it.

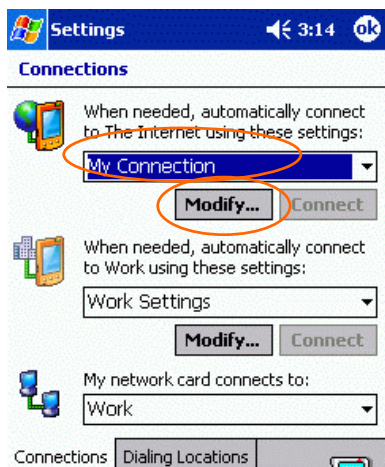

16. Tap on “**Proxy settings**”, tab on “**This network connects to Internet**”.

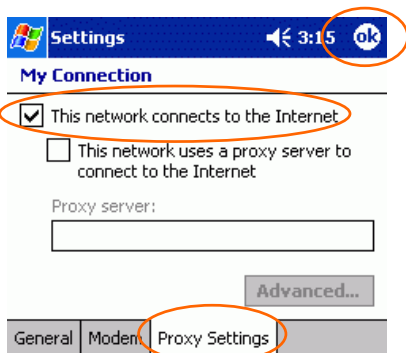

17. Tap “ok”.

18. Back to the “**Connections**” screen, on the last entry, tap on the dropdown menu and select “**The Internet**”.



19. Tap “Ok”.

20. Open the browser and see if you can open web pages.

APPENDIX A. SPECIFICATIONS

Network Interface Specifications

- IEEE 802.3 for 10BaseT
- IEEE 802.3u for 100BaseTX

Data Rate

- 10/100 Mbps¹

Host Interface and Physical Specifications

For Notebook PC: (accessory adapter)

- PCMCIA 2.0/2.1 and PC Card Standard compliant.
- Type II PC Card
- 5.39" x 2.128" x 0.197" (137mm x 54mm x 5.0mm)
- 55gw in weight with Compact Card

For PDA/Palm PC: (Compact Card Only)

- CF+ and CompactFlash Spec. Rev. 1.4 compliant.
- Type I CompactFlash I/O Card
- 3.46" x 1.685" x 0.130" (88mm x 42.8mm x 3.3mm)
- 28gw in weight

¹ CAT5 cable is required for 100M data transfer rate

Operating Systems

- Novell Netware 3.x, 4.x
- Microsoft LAN Manager
- Packet Driver Applications
- Microsoft Windows for Workgroups 3.11
- Windows 3.1
- Microsoft Windows NT 4.0
- Windows 98
- Windows 2000
- Windows ME
- Windows XP
- Windows CE 2.0 or newer
- Lantastic 6.0
- IBM OS/2 Warp Version 3

Power Requirements

Normal Operation: +3.3V DC, 155mA max
+5V DC, 175mA max

General Specification

LEDs: Link Integrity (Orange), Activity (Green)

Environments Ranges

Operating: 32°F to 149°F (0°C to 65°C)

Storage: -4°F to 158°F (0°C to 70°C)

Humidity: 10% - 90%, noncondensing

Certifications

FCC, Part 15, Class B, VCCI-B

CE Mark (EN55022, ClassB, EN50082-1)